

29MP Fixed Focal Length Lenses

Compatible to 8K line scan cameras



Product Features

- 1 High resolution
The resolution of whole FOV up to 100lp/mm
- 2 Big image circle
Suitable for 29MP area camera, max compatible with 8K line scan camera (pixel size below 5.6μm).
- 3 High uniformity
- 4 Low distortion
Total distortion below 0.9%, min distortion low to 0.2%.

Selection Guide

OPT-F2528-29M

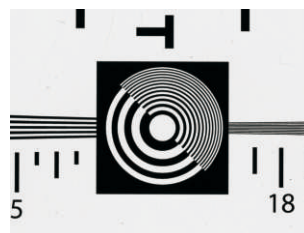
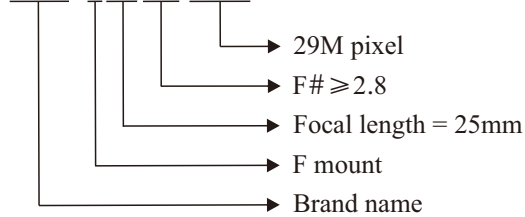

Picture taken via OPT-F2528-29M

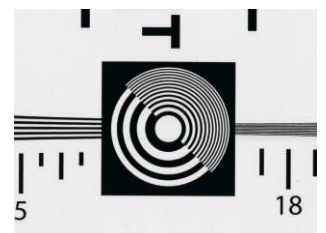

Picture taken via other lens

Application Examples



Surface inspection for beverage can

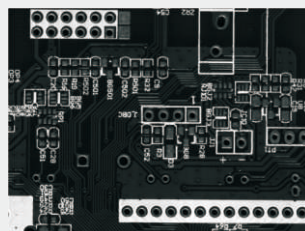

PCB board inspection



OCR for plastic parts

MTF Drawings

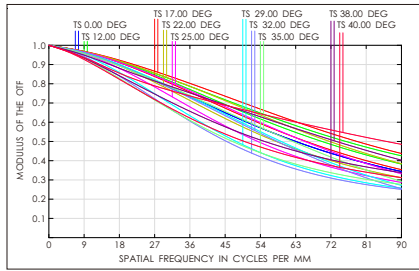

OPT-F2528-29M

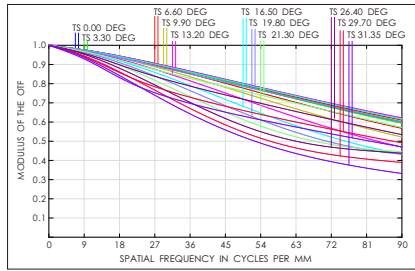

OPT-F3528-29M

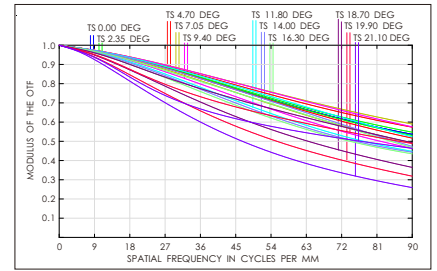

OPT-F5028-29M

Model Table

No	Model	Focal length (mm)	Aperture range	WD(mm)	Filter thread (mm)	Distortion	Flange distance (mm)	Weight (kg)	FOV angle					
									44mm	35mm	4/3"	1"	2/3"	1/2"
1	OPT-F2528-29M	25	F2.8-F32	140~∞	M77*P0.75	<0.9%	26.4	0.71	84°	71.3°	50°	36°	24.9°	18.1°
2	OPT-F3528-29M	35	F2.8-F32	180~∞	M58*P0.75	<0.4%	27.9	0.65	65°	53.6°	37°	26°	18°	6.7°
3	OPT-F5028-29M	50	F2.8-F32	180~∞	M58*P0.75	<0.2%	36.1	0.59	47.8°	38.8°	26°	18.2°	12.6°	9.1°

Dimensional Drawing [mm]

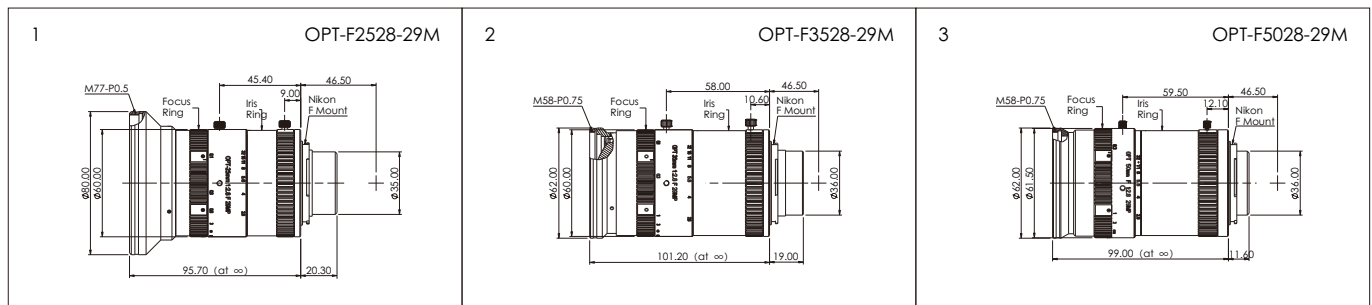

EHD imaging GmbH
 Zum Rennplatz 15
 D-49401 Damme
 Tel: +49-5491-2090
 email: info@ehdimaging.de
 web: www.ehd.de