

Magnetek
ELECTROBAR® FINGER SAFE (FS)
Conductor Bar System

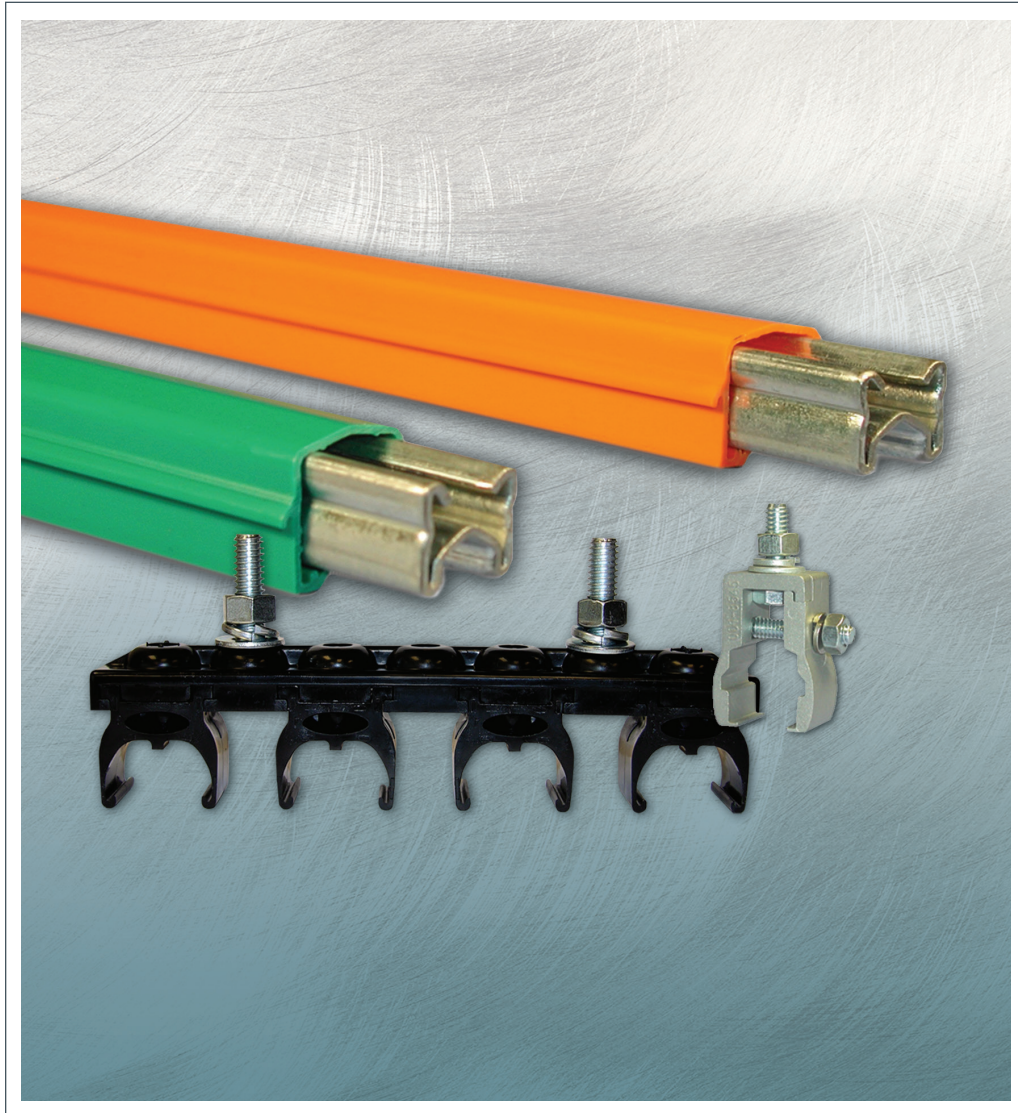

ELECTROBAR® FINGER SAFE (FS) CONDUCTOR BAR SYSTEM

Magnetek knows the safety and performance of your overhead material handling system are top priorities. That's why we proudly offer the Electromotive Systems Electrobar FS Conductor Bar System for the electrification of cranes, monorails and automated storage and retrieval systems.

CONDUCTOR BAR SHAPE ENHANCES PERFORMANCE

- Bar profile design ensures good electrical contact between the collector shoe and conductor bar.
- Wear of the conductor bar cover is minimized because the profile guides the shoe towards the center.
- Potential loss of electrical contact at joints is significantly reduced.
- Rigid conductor bar design minimizes deflection between hangers.

EASY TO INSTALL AND MAINTAIN

- Modular, snap-in multi-pole conductor bar hangers reduce installation and maintenance time.
- Compression-type anchor hangers (US Patent #6588713) eliminate field drilling.
- Expansion line elements come completely pre-assembled.
- Minimal system maintenance required—just periodically replace collector brush assemblies.

VALUE-PACKED SYSTEM

- Systems up to 490 feet in length can be installed without expansion assemblies.
- Standard 15' bar lengths mean fewer joints to purchase.
- Common hangers and joint assemblies.
- System design reduces installation labor costs.

DESIGNED WITH SAFETY IN MIND

- Finger safe design minimizes the potential for electrical contact.
- Grounding conductor bar available with green cover for ease of identification.

AVAILABLE IN A VARIETY OF CONFIGURATIONS

- Single and tandem shoe collector assemblies.
- 90, 110, 125, 250 and 400 Amp ratings.
- Snap-in hanger kits available for 2, 3 and 4 pole applications.
- Single hangers also available for special configurations.
- Many collector styles available.
- Can be used in horizontal or vertical mount applications.

Many parts of the Electrobar FS system are made from plastic insulating materials. The insulating covers for normal temperature use are made of PVC, the plastic hangers are made from polyamide (nylon) as are the plastic parts of the collectors. If your application uses materials or chemicals that can evaporate or get into the air and onto the conductor bar parts, please consult with Magnetek about the suitability of this product in your environment.

LINE ELEMENTS

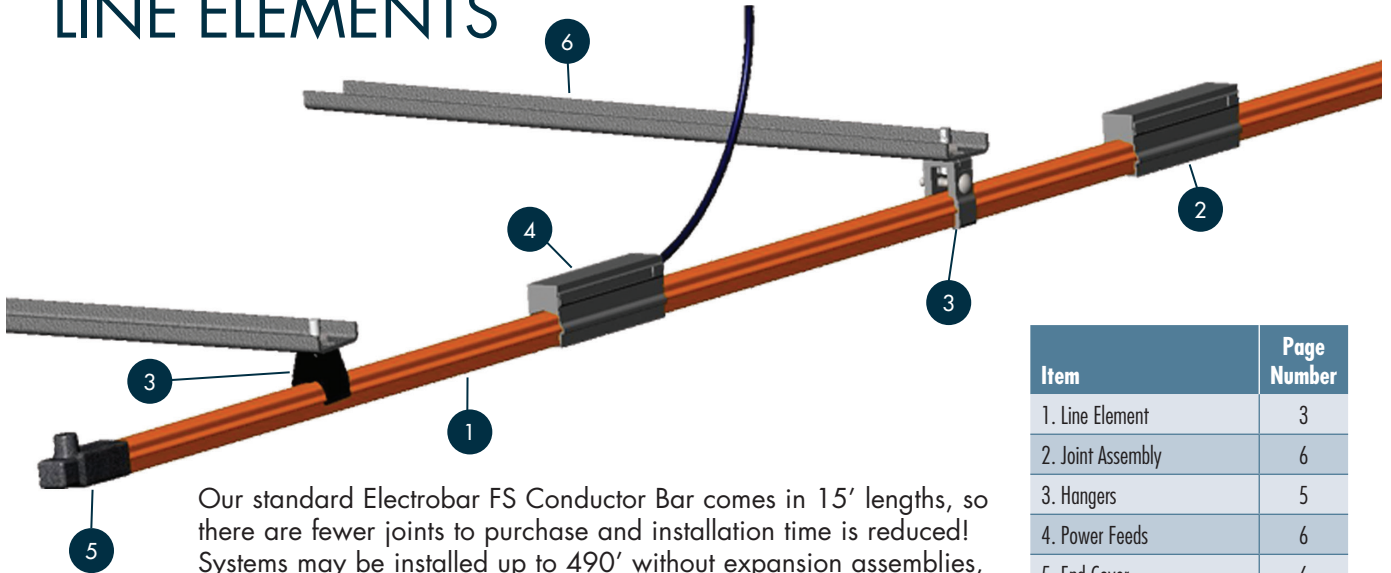

Our standard Electrobar FS Conductor Bar comes in 15' lengths, so there are fewer joints to purchase and installation time is reduced! Systems may be installed up to 490' without expansion assemblies, and in operating environments up to 160 degrees Fahrenheit. We include a green PVC conductor bar cover to provide electrical protection and easy identification of the grounding conductor.

Note: It is permissible to use the smallest rated bar as the ground. 90, 110, and 125 Amp Electrobar FS systems may use the 90 Amp FS Bar as the ground. On 400A systems, a 250A bar may be used as the grounding conductor.

Item	Page Number
1. Line Element	3
2. Joint Assembly	6
3. Hangers	5
4. Power Feeds	6
5. End Cover	6
6. Mounting Bracket	5
7. Expansions (not shown)	4
8. Transfer Cap (not shown)	6
9. Collectors (not shown)	7

1. ELECTROBAR FS GALVANIZED STEEL LINE ELEMENTS

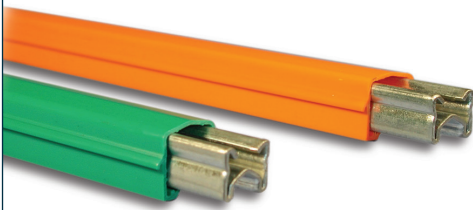

Catalog Number	Description	Standard Length	Weight	
			Lbs.	Kgs.
FS-90P15	90 Amp Electrobar FS Phase (Orange)	15' - 0"	7.4	3.4
FS-110P15	110 Amp Electrobar FS Phase (Orange)	15' - 0"	9.0	4.0
FS-125P15	125 Amp Electrobar FS Phase (Orange)	15' - 0"	9.0	4.0
FS-90G15	90 Amp Electrobar FS Ground (Green)	15' - 0"	7.4	3.4
FS-110G15	110 Amp Electrobar FS Ground (Green)	15' - 0"	9.0	4.0
FS-125G15	125 Amp Electrobar FS Ground (Green)	15' - 0"	9.0	4.0

Special length line elements are available from 1' to 14' in 1' increments designated by FS-(Amp Rating)(Phase or Ground)X, where X is equal to the length in feet.

Example: FS-90P5 is a 90 Amp Electrobar FS Phase X 5'-0".

1. ELECTROBAR FS COPPER LINE ELEMENTS

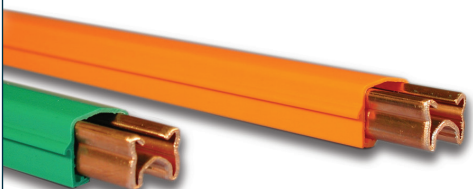

Catalog Number	Description	Standard Length	Weight	
			Lbs.	Kgs.
FS-250P15	250 Amp Electrobar FS Phase (Orange)	15' - 0"	7.5	3.4
FS-400P15	400 Amp Electrobar FS Phase (Orange)	15' - 0"	10.0	4.5
FS-250G15	250 Amp Electrobar FS Phase (Green)	15' - 0"	7.5	3.4
FS-400G15	400 Amp Electrobar FS Ground (Green)	15' - 0"	10.0	4.5

Special length line elements are available from 1' to 14' in 1' increments designated by FS-(Amp Rating)(Phase or Ground)X, where X is equal to the length in feet.

Example: FS-250P5 is a 250 Amp Electrobar FS Phase X 5'-0".

EXPANSION ELEMENTS

Our standard Electrobar FS expansion elements come in 15' lengths and include our PVC conductor bar cover and power feed covers. Expansions are completely pre-assembled, requiring only proper gap setting by the installer (refer to technical bulletin for gap setting data). Expansions may be installed in operating environments up to 160 degrees Fahrenheit.

7. ELECTROBAR FS GALVANIZED STEEL EXPANSION ELEMENTS

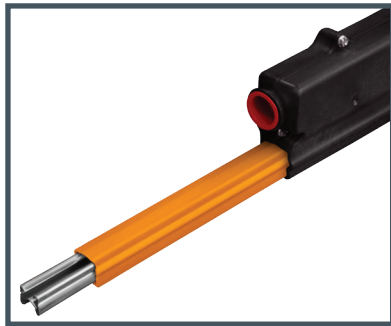

Systems at 490' or less do not require expansion elements when installed with anchor hangers at the center of the line. In systems longer than 490', expansions are needed every 240' based on a 100 degree Fahrenheit range in ambient temperature through the year.

Catalog Number	Description	Standard Length	Weight	
			Lbs.	Kgs.
FS-90EP15	90 Amp Electrobar FS Expansion Phase	15' - 0"	9.5	4.3
FS-110EP15	110 Amp Electrobar FS Expansion Phase	15' - 0"	11.5	5.2
FS-125EP15	125 Amp Electrobar FS Expansion Phase	15' - 0"	11.5	5.2
FS-90EG15	90 Amp Electrobar FS Expansion Ground	15' - 0"	9.5	4.3
FS-110EG15	110 Amp Electrobar FS Expansion Ground	15' - 0"	11.5	5.2
FS-125EG15	125 Amp Electrobar FS Expansion Ground	15' - 0"	11.5	5.2

7. ELECTROBAR FS COPPER EXPANSION ELEMENTS

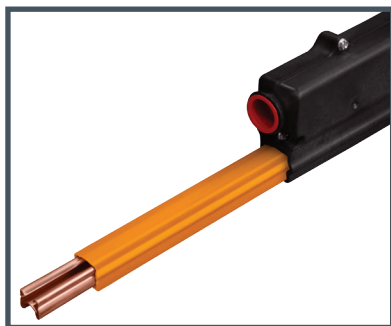

Systems at 490' or less do not require expansion elements when installed with anchor hangers at the center of the line. In systems longer than 490', expansions are needed every 165' based on a 100 degree Fahrenheit range in ambient temperature through the year.

Catalog Number	Description	Standard Length	Weight	
			Lbs.	Kgs.
FS-250EP15	250 Amp Electrobar FS Expansion Phase	15' - 0"	14.5	6.6
FS-400EP15	400 Amp Electrobar FS Expansion Phase	15' - 0"	17.0	7.7
FS-250EG15	250 Amp Electrobar FS Expansion Ground	15' - 0"	14.5	6.6
FS-400EG15	400 Amp Electrobar FS Expansion Ground	15' - 0"	17.0	7.7

TYPICAL SYSTEM LAYOUT

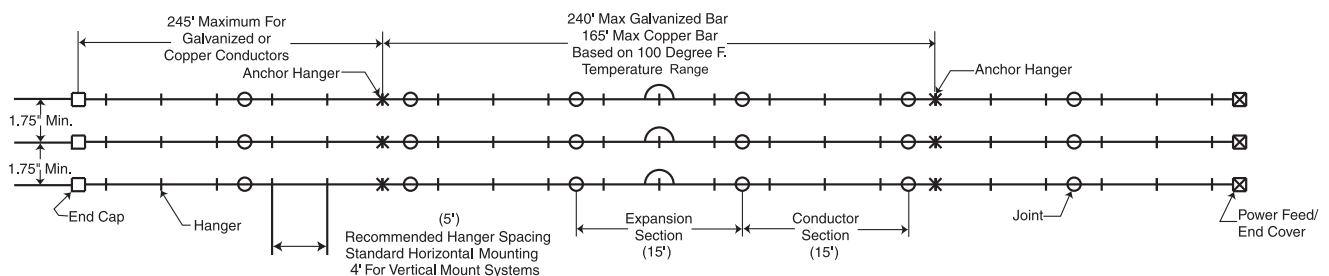

HANGERS

Electrobar FS multi-pole line element hangers have a modular, snap-in design for quick installation and ease of maintenance. Compression anchor hangers (US Patent #6588713) are available, eliminating the need for drilling.

A variety of configurations are available:

- Horizontal mount
- Vertical mount
- Modular hanger base for 2, 3 and 4 pole configurations
- Single plastic and steel hangers for special applications

3. HANGERS



Catalog Number	Description	Weight	
		Lbs.	Kgs.
FS-H4	4-Pole with 4 Snap-in Hangers	0.30	0.14
FS-H3	3-Pole with 3 Snap-in-Hangers	0.18	0.08
FS-H3L	3-Pole with 3 Snap-in Hangers (Vertical Mount Only)	0.18	0.08
FS-H2	2-Pole with 2 Snap-in Hangers	0.13	0.06
FS-SH	Single Hanger	0.10	0.05
FS-AH	Anchor Hanger	0.14	0.05
FS-HST	Steel Single Hanger	0.10	0.05
FS-H	Snap-in Hanger (Replacement)	0.03	0.01



MOUNTING CONFIGURATIONS

Horizontal Mounted Configurations - 5' Hanger Spacing

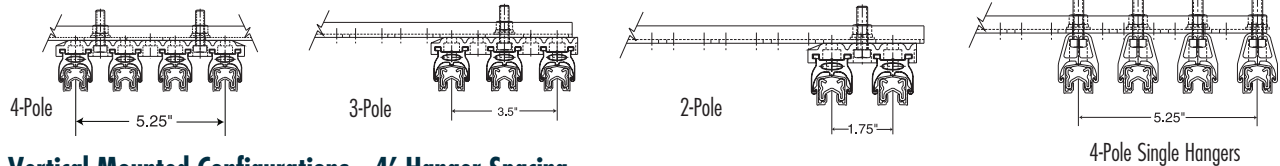

Vertical Mounted Configurations - 4' Hanger Spacing

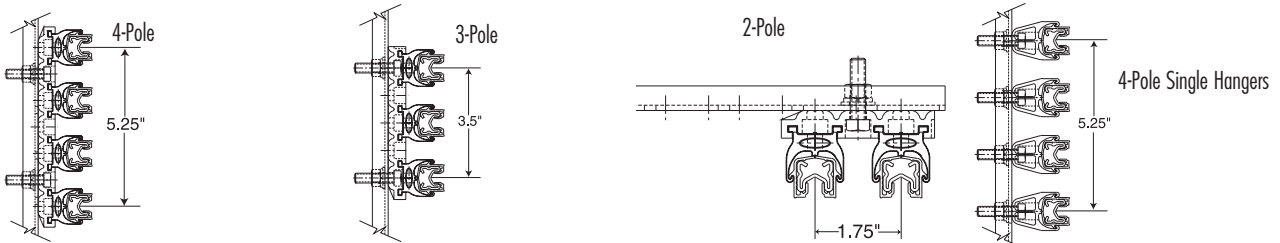

6. MOUNTING BRACKETS

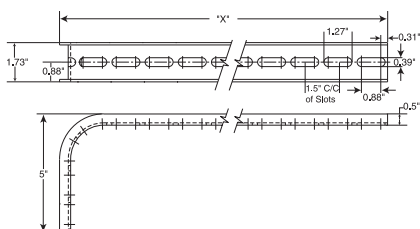

Bracket Catalog #	"X" Dimension
BKS-W15-G	11"
BKS-W18-G	14"
BKS-W24-G	20"

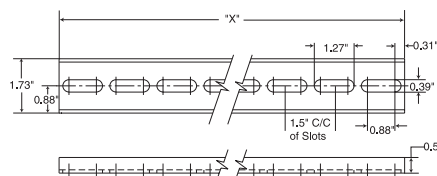

Bracket Catalog #	"X" Dimension
BKS-F18-G	18"
BKS-F24-G	24"

(Add an "A" after the F18 or F24 when ordering flange mount brackets including two mounting clamps.)

SYSTEM COMPONENTS

2. JOINT ASSEMBLY/JOINT COVER

90, 110, 125, 250 and 400 Amp

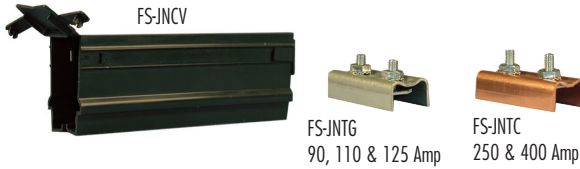

One joint cover and one joint assembly are required between each line element.

Catalog Number	Description	Weight	
		Lbs.	Kgs.
FS-JNTG	FS Joint Assembly Galvanized	0.10	0.05
FS-JNTC	FS Joint Assembly Copper	0.08	0.04
FS-JNCV	FS Joint Cover	0.05	0.02
FS-JJNC	FS Joint Compound	0.30	0.14

4. END POWER FEED

90, 110, 125 Amp

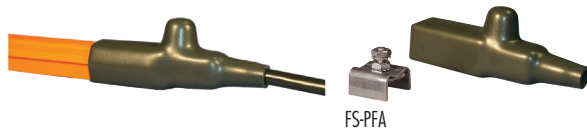

Power feed may be installed at the end of conductor bar line to feed power from one end of the conductor bar.

Catalog Number	Description	Weight	
		Lbs.	Kgs.
FS-PFA	End Power Feed	0.11	0.05

5. END COVER

90, 110, 125, 250 and 400 Amp



Required for installation at each end of the conductor bar system (required at only one end when end power feeds are used).

Catalog Number	Description	Weight	
		Lbs.	Kgs.
FS-END	FS End Cover	0.10	0.05

2. ISOLATION JOINT ASSEMBLY/JOINT COVER

90, 110, 125, 250 and 400 Amp



One joint cover and one joint assembly are required between each element.

Catalog Number	Description	Weight	
		Lbs.	Kgs.
FS-JNIS	FS Isolation joint	0.09	0.04
FS-JNCV	FS Joint Cover	0.05	0.02

4. JOINT POWER FEED

90, 110 and 125 Amp

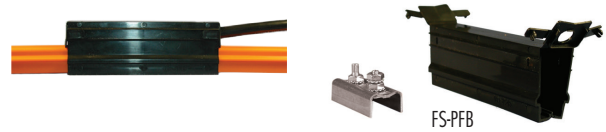

May be installed between any two line elements along the length of the system.

Catalog Number	Description	Weight	
		Lbs.	Kgs.
FS-PFB	FS Joint Power Feed	0.15	0.07

4. JOINT POWER FEED

250 and 400 Amp



May be installed between any two line elements along the length of the system.

Catalog Number	Description	Weight	
		Lbs.	Kgs.
FS-PFC	FS Joint Power Feed	1.25	0.57

8. TRANSFER CAP

90, 110, 125, 250 and 400 Amp



May be installed at switches or other breaks along the line where the collector shoe needs to transition between two conductor bar lines.

Catalog Number	Description	Weight	
		Lbs.	Kgs.
FS-TCAP	FS Transfer Cap	0.08	0.04

COLLECTOR ASSEMBLIES

Collector assemblies are designed to travel at speeds up to 900 ft. per minute using standardized components. Electrobar FS collectors feature an easy to install shoe assembly—simply insert the shoe and cotter pin and make the electrical connection. Our graphite impregnated copper contact shoes are designed for long life and minimal drag. Standard Electrobar FS collectors have a 100 or 200 Amp continuous current rating. Single or tandem collector shoe assemblies are available.

9. PANTOGRAPH/TANDEM ARM COLLECTOR ASSEMBLIES

Pantograph Collector PV-100PC

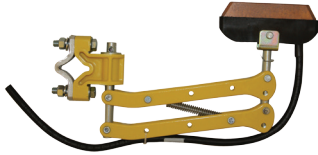

Collector PV-100C

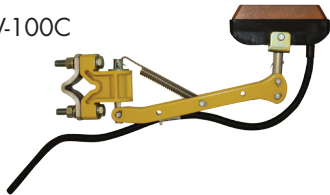

Lateral Collector PV-100PCL

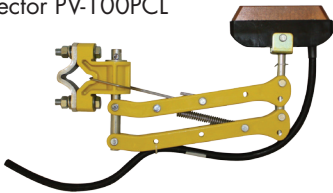

Pantograph Tandem Collector PV-200PTC

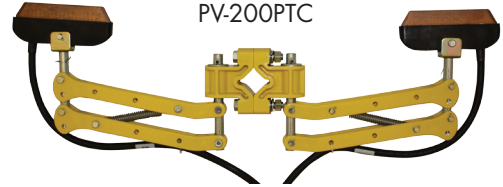

Tandem Collector PV-200TC

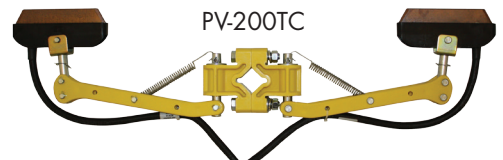

Tandem Lateral Collector PV-200PTCL

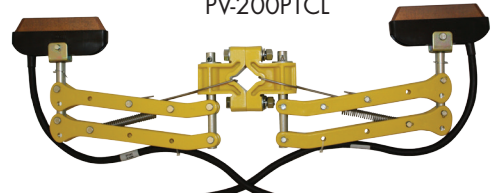

Single Arm

Amps	Catalog Number	Description	Weight	
			Lbs.	Kgs.
100 Amp	PV-100PC	Pantograph Collector	2.0	0.91
100 Amp	PV-100C	Collector	1.8	0.8
100 Amp	PV-100PCL	Lateral Collector	2.0	0.91

Tandem Arm

Amps	Catalog Number	Description	Weight	
			Lbs.	Kgs.
200 Amp	PV-200PTC	Pantograph Collector	4.0	1.8
200 Amp	PV-200TC	Collector	3.6	1.6
200 Amp	PV-200PTCL	Lateral Collector	4.0	1.8

For fixed mounting posts 3.50" – 4.50" from conductor bar running surface.

REPLACEMENT SHOE ASSEMBLY



Single collector shoe for quick and easy replacement. Used on all collector assemblies above.

Catalog Number	Description	Weight	
		Lbs.	Kgs.
V-100CH	Replacement Collector Shoe Assembly	0.24	0.11

COLLECTOR MOUNTING POST

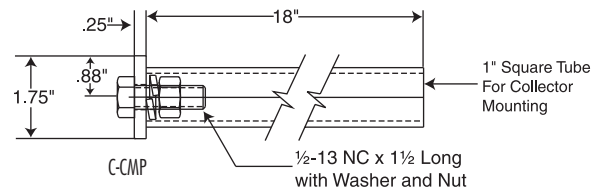

Catalog Number	Description	Weight	
		Lbs.	Kgs.
C-CMP	Collector Mounting Post	4	1.8



YOUR ONE-STOP SOURCE FOR MATERIAL HANDLING CONTROL SOLUTIONS



ENGINEERED SYSTEMS & SOLUTIONS

Project Evaluation
Project Management
Engineering Design
System Manufacturing and Testing
Field Startup, Testing, Training and Support
Customer Training and Maintenance Support
Application Solutions
PLC/PC Program Development

**IMPULSE™ AC ADJUSTABLE
FREQUENCY DRIVES**

230, 460 and 575 Volt Power Platforms
0.25–1,500 HP
Exclusive Application Software
Specific Crane & Hoist Software

OMNIPULSE™ DIGITAL DRIVES

DSD – AC in/DC out
15–800 HP
DDC – DC in/DC out
5–500 HP

MAGNEPULSE™ DIGITAL MAGNET CONTROL

MAC™•2000 MOTOR ACCELERATION CONTROL

Single & 2 Speed — up to 15.2 Amps
Contactor Panels

VARIABLE SPEED MOTOR CONTROL PANELS

Standard Pre-Engineered Systems
Custom Engineered Systems

MOTORS & ACCESSORIES

Standard Inverter Duty AC Induction Motors
Flux Vector Designed Motors

POWER DELIVERY SYSTEMS

ELECTROBAR® ELITE — 20, 60, 100, 130, 200 Amps
FABA® Conductor Bar Systems — 100 Amps
ELECTROBAR® HX — 400, 700, 1000 Amps
ELECTROBAR® FS — 90, 110, 125, 250, 400 Amps
ELECTROBAR® 8-Bar — 90, 110, 350 Amps

ELECTROMOTIVE™ FESTOONING SYSTEMS

Standard Duty
Heavy Duty
Mill Duty

PENDANT PUSHBUTTON STATIONS
Standard, Custom and Wired

**TELEMOTIVE & ENRANGE RADIO REMOTE
CONTROL SYSTEMS**

Flex EX
Flex Pro
telePendant™
300T
Pendant™
telePilot™
100T
PGT
DTX
MLTX™
MLTX2™
SLTX™
700T
JLTX™
Locomotive Control Systems

COLLISION AVOIDANCE SYSTEMS

LaserGuard™
ReFlx™

MONDEL BRAKES

200S Industrial Shoe Brakes
4"–19" Diameter
6–2,250 Lb. Ft. Torque
AC, DC, Hydraulic Actuators
AC Explosion Proof Actuators

AIST-NEMA 300M Mill Duty Shoe Brakes

5"–30" Diameter
10–11,000 Lb. Ft. Torque
AC, DC, Hydraulic Actuators
AC Explosion Proof Actuators

400D Heavy Duty Disc Brakes

8"–50" Diameter
50–30,000 Lb. Ft. Torque
AC, DC, Hydraulic Actuators
AC Explosion Proof Actuators

Braketronic™ Control System

Braketronic Controller
Standard Pre-engineered Panel
Mill Duty Foot Pedal (optional)

N49 W13650 Campbell Drive
Menomonee Falls, WI 53051
Toll-Free Phone 800.288.8178
Toll-Free Fax 800.298.3503
Phone 262.783.3500
Fax 262.783.3510

Canada Facility
4090B Sladeview Crescent
Mississauga, Ontario
Canada L5L 5Y5
Toll-Free Phone 800.792.7253
Phone 905.828.1526
Fax 905.828.5707

WWW.MAGNETEKMH.COM