



SERIES 'G' HORIZONTAL PUMPS

Self-priming centrifugal pumps for transfer and recirculation of:

CHEMICAL SOLUTIONS / WASTE TREATMENT
PHOTOGRAPHIC SOLUTIONS (inorganic)



Close-coupled
to electric motor
w/polypropylene baseplate

- Flows to 100 U.S. GPM or 73 ft. TDH @ 60 Hz (315 LPM or 15m @ 50 Hz)
- Noryl® or Ryton® construction with 316 SS internal hardware (See a chemical resistance chart)
- Non-metallic solution contact available
- Will reprime to 15 feet (4.6m)*
- Close coupled - electric motor driven
- Shaft sleeve is same material as pump Isolates pump shaft from solutions.
- Combination 2" O.D. MNPT x 1½" I.D. FNPT connections

The self-priming Series 'G' Pump is made in either Noryl or Ryton, providing a maximum range of chemical resistance. It is available with 316 stainless steel, internal hardware or completely non-metallic solution contact. The pump comes standard with 304 stainless external hardware. The pump is protected with a basket-type strainer in either polypropylene or ECTFE. The large cover makes initial priming and removal of the strainer quick and easy. The cover is the same material as the pump or it can be ordered in clear Lexan® (PCN 64-1818 90). A polypropylene baseplate is

included with close-coupled electric drive pumps. After initial prime, the Series 'G' Pump will lift up to 15 vertical feet (4.6m) and will remain primed even after shutdown. This pump also features an open, non-clogging impeller which is molded in conjunction with the shaft sleeve, thus isolating the shaft from solution contact.

The self-priming ability, chemical resistance, light weight and basket strainer make this an ideal pump for chemical transfer, waste treatment, emergency/backup or filtering.

* Based on water-like liquids @ 70°F and 60 Hz (3450 RPM) operation after initial priming of pump housing.

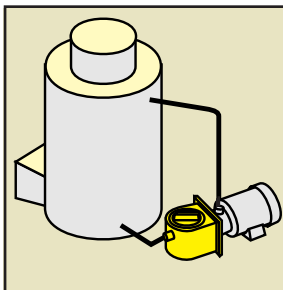

RECIRCULATION OF
COOLING TOWERS, MIXING
VATS

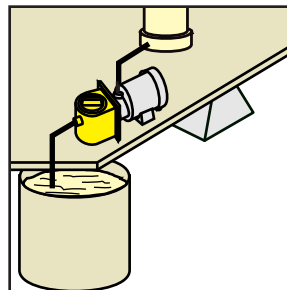

FILTRATION

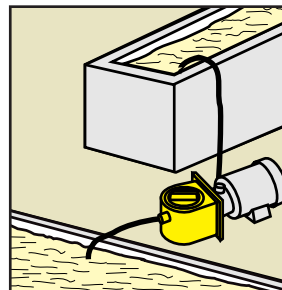

LIFTING FROM PONDS,
TANKS, SUMPS, PITS

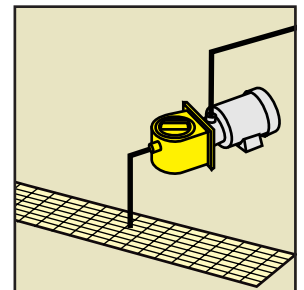

EMERGENCY STANDBY

SERIES 'G' HORIZONTAL PUMPS Specifications

All data based on water (specific gravity = 1.0).
Impeller part numbers marked on curves.

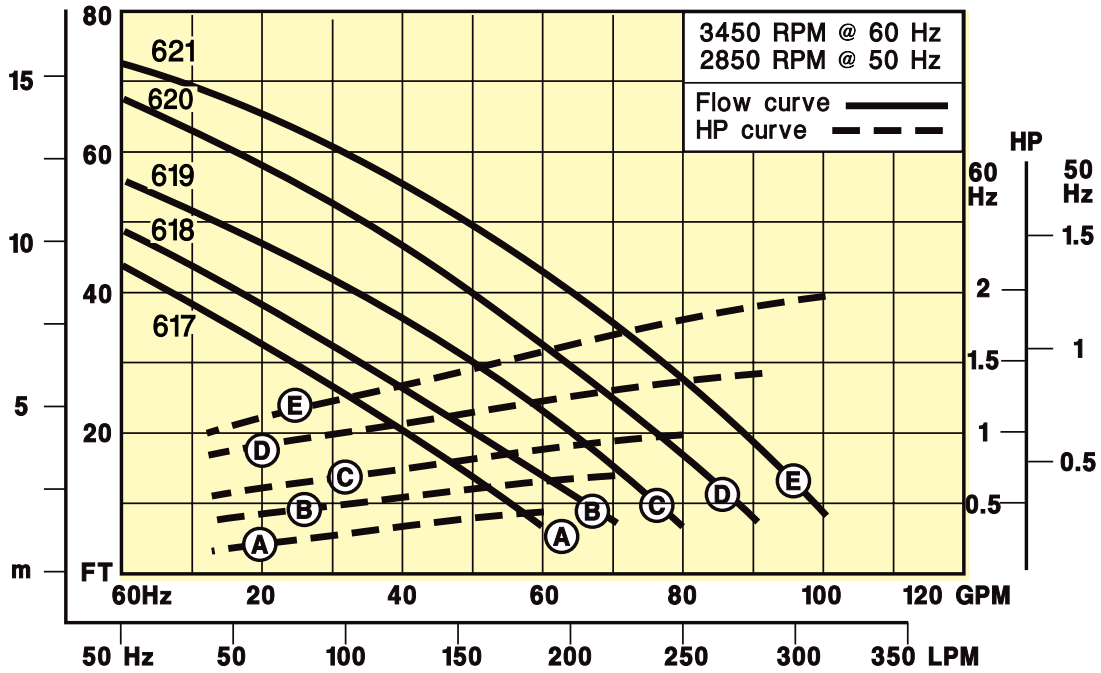

DIMENSIONS Inches (mm)

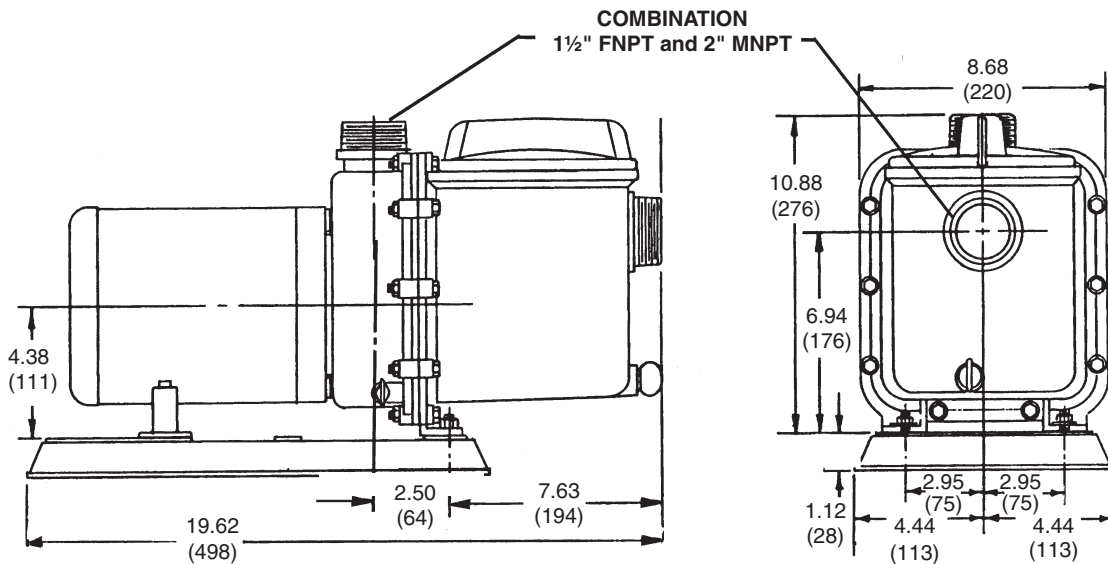

Ports have dual thread —
1½" FNPT and 2" MNPT
on both suction and discharge.

SERIES 'G' HORIZONTAL PUMPS Ordering information

TO ORDER, use Price Code No.

Identify flow curve on graph that corresponds to desired performance and choose from Noryl or Ryton pumps below. Order non-metallic pump for fluids that might attack metal internals. (See a chemical resistance chart.) Required horsepower is based on water @ 1.0 specific gravity. To determine required HP for liquids of specific gravity greater than 1.1, select performance point on flow curve, move vertically to corresponding HP curve and then horizontally to HP scale. Multiply indicated HP by specific gravity and select motor accordingly.

Choose from:

- | | |
|---|--|
| <p>A Pumps molded of glass-reinforced Noryl with polypropylene basket strainer, ethylene propylene elastomers, 316 stainless steel internal hardware, 304 stainless steel external hardware, carbon-ceramic and 316 stainless steel mechanical seal.</p> | <p>C Pumps molded of glass-reinforced Ryton with ECTFE basket strainer, Viton elastomers, 316 stainless steel internal hardware, 304 stainless steel external hardware, carbon-ceramic and 316 stainless steel mechanical seal.</p> |
| <p>B Same as A but with non-metallic solution contact and ECTFE / EPDM / siliconized-graphite non-metallic mechanical seal.</p> | <p>D Same as C but with non-metallic solution contact and ECTFE / Viton / siliconized-graphite non-metallic mechanical seal.</p> |

SERIES 'G' PUMPS with electric drive, close coupled

FLOW CURVE	PORT SIZE	MAXIMUM FLOW RATE	MAX. TDH	REQUIRED HP	A NORYL		B NON-METALLIC		CLOSE-COUPLED ELEC. MOTOR			
					MODEL NUMBER	PRICE CODE NO.	MODEL NUMBER	PRICE CODE NO.	ADD TO MODEL NUMBER & PRICE CODE NUMBER			
									115-230V/1/50-60		230-460V/3/50-60	
									ODP	TEFC	ODP	TEFC
A	Comb. 1½" F and 2" M	60 (204)	44 (9)	.5 (.3)	GNOK1½/2AL-	60-61A4-	GNOK1½/2ALN-	60-61A9-	K.5C	C.5C	T.5C	D.5C
B		70 (223)	49 (10)	.75 (.4)	GNOK1½/2BL-	60-61B4-	GNOK1½/2BLN-	60-61B9-	K.75C	C.75C	T.75C	D.75C
C		80 (246)	57 (12)	1.0 (.6)	GNOK1½/2CL-	60-61C4-	GNOK1½/2CLN-	60-61C9-	K1.0C	C1.0C	T1.0C	D1.0C
D		90 (288)	68 (14)	1.5 (.9)	GNOK1½/2DL-	60-61D4-	GNOK1½/2DLN-	60-61D9-	K1.5C	C1.5C	T1.5C	D1.5C
E		100 (330)	73 (15)	2.0 (1.2)	GNOK1½/2EL-	60-61E4-	GNOK1½/2ELN-	60-61E9-	K2.0C	C2.0C	T2.0C	D2.0C
									K3.0C *	C3.0C *	T3.0C	D3.0C

(A) Noryl — For Viton elastomers, change 4 to 1 in Price Code Number and L to V in Model Number.

(B) Non-metallic — For Viton elastomers, change 9 to 8 in Price Code Number and LN to VN in Model Number.

* 230V / 1 / 60 Hz

FLOW CURVE	PORT SIZE	MAXIMUM FLOW RATE	MAX. TDH	REQUIRED HP	C RYTON		D NON-METALLIC		CLOSE-COUPLED ELEC. MOTOR			
					MODEL NUMBER	PRICE CODE NO.	MODEL NUMBER	PRICE CODE NO.	ADD TO MODEL NUMBER & PRICE CODE NUMBER			
									115-230V/1/50-60		230-460V/3/50-60	
									ODP	TEFC	ODP	TEFC
A	Comb. 1½" F and 2" M	70 (223)	49 (10)	.75 (.4)	GRYK1½/2AV-	60-81A1-	2AVN-	60-81A8-	K.5C	C.5C	T.5C	D.5C
B		80 (246)	57 (12)	1.0 (.6)	GRYK1½/2BV-	60-81B1-	GRYK1½/2BVN-	60-81B8-	K.75C	C.75C	T.75C	D.75C
C		90 (288)	68 (14)	1.5 (.9)	GRYK1½/2CV-	60-81C1-	GRYK1½/2CVN-	60-81C8-	K1.0C	C1.0C	T1.0C	D1.0C
D		100 (330)	73 (15)	2.0 (1.2)	GRYK1½/2DV-	60-81D1-	GRYK1½/2DVN-	60-81D8-	K1.5C	C1.5C	T1.5C	D1.5C
E		(204) 44 (9)	.5 (.3)	GRYK1½/2EV-	60-81E1-	GRYK1½/2EVN-	60-81E8-	K2.0C	C2.0C	T2.0C	D2.0C	
									K3.0C *	C3.0C *	T3.0C	D3.0C

(C) Ryton — For EPDM elastomers, change 1 to 4 in Price Code Number and V to L in Model Number.

(D) Non-metallic — For EPDM elastomers, change 8 to 9 in Price Code Number and VN to LN in Model Number.

* 230V / 1 / 60 Hz

Consult Sales Department for pedestal mounted, long coupled, pneumatic driven or engine driven models.



PERFECT PUMPS FOR CHEMICALS

Proudly Made in the USA, SERFILCO Offers the Widest Range of Chemical Pumps Anywhere.

'EH' Vertical Pump

- Can Run Dry
- Extended Column to 10'
- Flows to 185 gpm, 145 ft. TDH



'HE' Horizontal Pump

- Single or Double Mech. Seal
- Variety of Material Types
- Flows to 175 gpm, 140 ft. TDH



'ME' Magnetic Coupled Pump

- Seal-less Magnetic Coupled
- Polypropylene or PVDF
- Flows to 95 gpm, 54 ft. TDH



'EF' Vertical Pump

- Can Run Dry
- Suction Extension to 3'
- Flows to 400 gpm, 170 ft. TDH



'HF' Horizontal Pump

- Single or Double Mech. Seal
- Variety of Material Types
- Flows to 400 gpm, 160 ft. TDH



'FE' Magnetic Coupled Pump

- Seal-less Magnetic Coupled
- Polypropylene or PVDF
- Flows to 130 gpm, 97 ft. TDH



'EHM' Vertical Pump

- Can Run Dry
- Suction Extension to 3'
- Flows to 650 gpm, 115 ft. TDH



'HA' Horizontal Pump

- Single or Double Mech. Seal
- Machined from Solid CPVC
- Flows to 1200 gpm, 115 ft. TDH

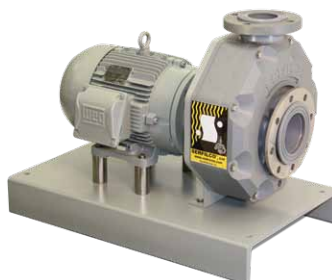

'FES' Magnetic Coupled Pump

- Seal-less Magnetic Coupled
- Polypropylene or PVDF
- Flows to 250 gpm, 175 ft. TDH

