

PRESSURE, VACUUM, DIFFERENTIAL PRESSURE AND TEMPERATURE SWITCHES



FEATURES

- Single Switch Output
- Epoxy Coated and Gasketed Cast Aluminum Enclosure Type 4X
- Tamper-Resistant Set Point "Lock"
- Heat Trace and Freeze Protection Thermostats
- Proof Pressures to 10,000 psi (689,5 bar)
- Adjustable Ranges:

Pressure:
30 "Hg Vac to 5000 psi
(-1 to 344,7 bar)

"wc Ranges:
300 "wc Vacuum to 250 "wc Pressure
(-746,7 to 622,3 mbar)

Differential Pressure:
0.2 "wcd to 500 psid
(0,5 mbar to 34,5 bar)

Temperature:
-180 to 650°F
(-117.8 to 343.3°C)



OVERVIEW

The 100 Series is a cost-effective pressure and temperature switch for process plants and OEM equipment. The rugged, one piece enclosure features a slanted cover for wiring accessibility.

A wide variety of microswitch and process-connection options make this versatile series ideal for applications requiring a rugged weather-proof mechanical switch.

Typical applications that utilize the 100 Series are heat tracing, freeze protection, processing equipment (pumps, compressors), inputs for annunciator panels, and fire suppression systems.

FEATURES

- UL listed and cUL certified.
- CE compliant to low voltage directive and pressure equipment directive.
- Optional ATEX or GOST intrinsic safety compliance
- Single switch (SPDT or DPDT) output
- Welded stainless steel diaphragm models
- Ultra low pressure, "wc models
- Optional sensor material for corrosive media
- Polished stainless steel flush-mount connection
- Pump switch models with wide adjustable deadband



"Clam shell" design allows for ease in wiring (pressure model shown)



Bulb and capillary temperature model with manual reset option



Differential pressure model

SPECIFICATIONS

| | |
|--|---|
| STORAGE TEMPERATURE | -65 to 160°F (-54 to 71 °C) |
| AMBIENT TEMPERATURE LIMITS | -40 to 160°F (-40 to 71 °C); models 520-525, 540-548, 700-706, 15731-15736: 0 to 160°F (-18 to 71 °C); Set point typically shifts less than 1% of range for a 50°F (28°C) ambient temperature change |
| SET POINT REPEATABILITY | Temperature models: ± 1% of adjustable range Pressure models 15623, 15731-15737, 171-174, 218, 270-376, 520-535, 540-543, 700-706, 560-564: ± 1% of adjustable range; models 190-194, 183-189, 483-494, 544-548, 565-567, 610-680, 15884: ±1.5% of adjustable range Internal set point lock on all pressure models |
| SHOCK | Set point repeats after 15 G, 10 millisecond duration |
| VIBRATION | Set point repeats after 2.5 G, 5-500 Hz |
| ENCLOSURE | Die cast aluminum, epoxy powder coated, gasketed, captive cover screws |
| ENCLOSURE CLASSIFICATION | Enclosure type 4X |
| SWITCH OUTPUT | One SPDT snap action switch; switch may be wired "normally open" or "normally closed" |
| ELECTRICAL RATING | 15A 125/250/480 VAC resistive except for H100-15623, 15731-15737, 15884, 20A 125/250/480 VAC resistive, B100-13546 and E100-13545, 22A/480 VAC. Electrical switches have limited DC capabilities at 24-30 VDC, 2A resistive and 1A inductive. 125 VDC, 0.5A resistive, 0.03A inductive. Consult factory for additional information. |
| WEIGHT | 2-7 lbs; Varies with model |
| ELECTRICAL CONNECTION | 1/2" NPT (female); Two 7/8" diameter knockouts |
| PRESSURE CONNECTION | Models 15623, 218, 270-376, 610-680, 701-706, 15731-15884: 1/4" NPT (female); Models 171-194, 483-494, 520-535, 15737: 1/2" NPT (female); Models 540-548: 1/8" NPT (female); Models 560-564: 2" Sanitary Fitting; Models 565-567: 1.5" Sanitary Fitting (Sanitary fittings mate with Tri-Clamp® fitting systems) |
| TEMPERATURE ASSEMBLY | Bulb and capillary: 6 feet 304 stainless steel except for E100-13545, 10 feet 304 stainless steel Immersion stem: nickel-plated brass (standard) except for B100-13546 stainless steel; optional 316L stainless steel |
| FILL | Models 1BS/BC are solvent filled, models 2-8 non-toxic oil filled |
| TEMPERATURE DEADBAND | Type F typically 1% and type B, C, and E typically 2% of range under laboratory conditions (70°F ambient circulating bath at rate of 1/2°F per minute change) |
| HEAT TRACING OR FREEZE PROTECTION | Thermostats designed specifically for heat tracing and freeze protection ambient sensing applications are available with types B100 and E100 |

APPROVALS



UNITED STATES AND CANADA

UL Listed, **cUL** Certified

Temperature: UL 873; CSA C22.2 no. 24, File # E10667

Pressure: UL 508; CSA C22.2 no. 14, File # E42272;

Enclosure Type 4X



EUROPE

ATEX Directive (94/9/EC)

II 1 G EEx ia IIC T6, **(OPTIONAL - code M405)**

Tamb = -50°C to +60°C

UL International DEMKO A/S (N.B.#0539)

Certificate #DEMKO 03 ATEX 0335063

EN 50014, 50020, 50284



Low Voltage Directive (LVD) (73/23/EC & 93/68/EEC)

UEC compliant to LVD

Products rated lower than 50 VAC and 75 VDC are outside of the scope of the LVD

Pressure Equipment Directive (PED) (97/23/EC)

Compliant to PED

Products rated lower than 7.5 psi are outside the scope of the PED



RUSSIA

Gosgortekhnadzor Permit **(OPTIONAL - code M406)**

0ExiaIIC T6

Tamb = -50°C to +60°C

NANIO CCVE Certification Center

Certificate # ROSS US.GB05.Bo2933

GOST R 51330.0, 51330.1, 51330.10 & 51330.14

PRESSURE MODEL CHART

| Model | Adjustable Set Point Range | | Deadband | | Over Range Pressure* | | Proof Pressure** | | |
|---|---|------------------|---------------------|--------------------|----------------------|----------------------|------------------|------------------|-------------------|
| | Low end of range on fall; High end of range on rise "wc | mbar | "wc | mbar | psi | bar | psi | bar | |
| Type H100 | | | | | | | | | |
| Buna N diaphragm and O-Ring with epoxy coated aluminum 1/2" NPT (female) pressure connection, large 0.72" orifice for clean-out purposes (other wetted materials available see page 11) | | | | | | | | | |
| 520 | 300 Vac to 0 | -746,7 to 0 | 0.2 to 8 | 0,5 to 19,9 | 200 | 13,8 | 400 | 27,6 | |
| 521 | 10 Vac to 10 | -24,9 to 24,9 | 0.1 to 0.6 | 0,2 to 1,5 | 200 | 13,8 | 400 | 27,6 | |
| 522 | 50 Vac to 50 | -124,5 to 124,5 | 0.1 to 3 | 0,2 to 7,5 | 200 | 13,8 | 400 | 27,6 | |
| 523 | 0.5 to 5.0 | 1,2 to 12,4 | 0.1 to 0.3 | 0,2 to 0,7 | 200 | 13,8 | 400 | 27,6 | |
| 524 | 2.5 to 50 | 6,2 to 124,5 | 0.1 to 0.8 | 0,2 to 2,0 | 200 | 13,8 | 400 | 27,6 | |
| 525 | 10 to 250 | 24,9 to 622,3 | 0.1 to 6 | 0,2 to 14,9 | 200 | 13,8 | 400 | 27,6 | |
| Welded 316L stainless steel diaphragm and 1/2" NPT (female) pressure connection, large 0.72" orifice for clean-out purposes | | | | | | | | | |
| 530 | 300 Vac to 0 | -746,7 to 0 | 0.2 to 15 | 0,5 to 37,3 | 50 | 3,4 | 100 | 6,9 | |
| 531 | 10 Vac to 10 | -24,9 to 24,9 | 0.1 to 0.6 | 0,2 to 1,5 | 50 | 3,4 | 100 | 6,9 | |
| 532 | 50 Vac to 50 | -124,5 to 124,5 | 0.1 to 3 | 0,2 to 7,5 | 50 | 3,4 | 100 | 6,9 | |
| 533 | 0.5 to 5.0 | 1,2 to 12,4 | 0.1 to 0.3 | 0,2 to 0,7 | 50 | 3,4 | 100 | 6,9 | |
| 534 | 2.5 to 50 | 6,2 to 124,5 | 0.1 to 0.8 | 0,2 to 2,0 | 50 | 3,4 | 100 | 6,9 | |
| 535 | 10 to 250 | 24,9 to 622,3 | 0.1 to 10 | 0,2 to 24,9 | 50 | 3,4 | 100 | 6,9 | |
| Model | Adjustable Set Point Range | | Adjustable Deadband | | | Over Range Pressure* | | Proof Pressure** | |
| | "wc | mbar | Low End "wc | Mid Range "wc | High Range "wc | psi | bar | psi | bar |
| Buna N diaphragm and O-Ring with epoxy coated aluminum, 1/2" NPT (female) pressure connection, large 0.72" orifice for clean-out purposes; includes adjustable deadband microswitch | | | | | | | | | |
| 15737 | 50 Vac to 50 | -124,5 to 124,5 | 0.5 to 7 | 1,2 to 17,4 | 1 to 10 | 2,5 to 24,9 | 2 to 13 | 5,0 to 32,4 | 200 13,8 400 27,6 |
| Deadband | | | | | | | | | |
| | | | psi | bar (unless noted) | psi | mbar | psi | bar | psi bar |
| Welded 316L stainless steel diaphragm and 1/2" NPT (female) pressure connection, large 0.72" orifice for clean-out purposes (NACE MR-0175 compliant) | | | | | | | | | |
| 171 | 1 to 20 | 68,9 mbar to 1,4 | 0.1 to 1 | 6,9 to 68,9 | | | 500 | 34,5 | 1000 68,9 |
| 172 | 2 to 50 | 0,1 to 3,4 | 0.1 to 1.5 | 6,9 to 103,4 | | | 500 | 34,5 | 1000 68,9 |
| 173 | 4 to 100 | 0,3 6,9 | 0.1 to 2.5 | 6,9 to 172,4 | | | 500 | 34,5 | 1000 68,9 |
| 174 | 8 to 200 | 0,6 to 13,8 | 0.1 to 3.5 | 6,9 to 241,3 | | | 500 | 34,5 | 1000 68,9 |
| 2" sanitary welded 316L stainless steel diaphragm and pressure connection. Mates with Tri-Clamp® fitting systems (not UE supplied) | | | | | | | | | |
| 560 | 0.5 to 15 | 34,5 mbar to 1.0 | 0.1 to 1 | 6,9 to 68,9 | | | 200 | 13,8 | 300 20,7 |
| 561 | 1 to 25 | 68,9 mbar to 1,7 | 0.1 to 1.5 | 6,9 to 103,4 | | | 200 | 13,8 | 300 20,7 |
| 562 | 2 to 50 | 0,1 to 3,4 | 0.1 to 2.5 | 6,9 to 172,4 | | | 200 | 13,8 | 300 20,7 |
| 563 | 4 to 100 | 0,3 6,9 | 0.1 to 4 | 6,9 to 275,8 | | | 200 | 13,8 | 300 20,7 |
| 564 | 8 to 200 | 0,6 to 13,8 | 0.1 to 5 | 6,9 to 344,7 | | | 200 | 13,8 | 300 20,7 |

Tri-Clamp® is a registered trademark of Alfa Laval.

Application Note: The use of metallic diaphragms where higher pressure shock or heavy cycling is expected should be avoided. Models 171-174 should not be used where system or start-up vacuum pressure might exceed 26" Hg Vac (-0.9 bar).

* **Over Range Pressure:** The maximum pressure that may be applied continuously without causing damage and maintaining set point repeatability.

** **Proof Pressure:** The maximum pressure to which a pressure sensor may be occasionally subjected, which causes no permanent damage. The unit may require calibration (e.g., start-up, testing).



PRESSURE MODEL CHART

| Model | Adjustable Set Point Range | | Deadband | | Over Range Pressure* | | Proof Pressure** | |
|-------|----------------------------|--------------------|----------|--------------------|----------------------|-----|------------------|-----|
| | psi | bar (unless noted) | psi | bar (unless noted) | psi | bar | psi | bar |

Type H100

1.5" sanitary welded 316L stainless steel diaphragm and pressure connection. Mates with Tri-Clamp® fitting systems (not UE supplied)

| | | | | | | | | |
|-----|-----------|-------------|---------|------------------|------|------|------|-------|
| 565 | 5 to 30 | 0,3 to 2,1 | 1 to 5 | 68,9 mbar to 0,3 | 1000 | 68,9 | 1500 | 103,4 |
| 566 | 10 to 100 | 0,7 to 6,9 | 1 to 12 | 68,9 mbar to 0,8 | 1000 | 68,9 | 1500 | 103,4 |
| 567 | 15 to 300 | 1,0 to 20,7 | 3 to 22 | 0,2 to 1,5 | 1000 | 68,9 | 1500 | 103,4 |

Buna-N diaphragm and O-ring with nickel-plated brass 1/4" NPT (female) pressure connection; Option M540 Viton® diaphragm and O-ring available for models 701-705

| | | | | | | | | |
|-----|-------------|-------------------|----------|------------------|------|-------|------|-------|
| 701 | 1.5 to 30 | 103,4 mbar to 2,1 | 1 to 2 | 68,9 mbar to 0,1 | 500 | 34,5 | 600 | 41,4 |
| 702 | 3 to 100 | 0,2 to 6,9 | 1 to 4 | 68,9 mbar to 0,3 | 500 | 34,5 | 600 | 41,4 |
| 703 | 9 to 300 | 0,6 to 20,7 | 1 to 5 | 68,0 mbar to 0,3 | 500 | 34,5 | 600 | 41,4 |
| 704 | 15 to 500 | 1,0 to 34,5 | 2 to 8 | 0,1 to 0,6 | 1500 | 103,4 | 2500 | 172,4 |
| 705 | 30 to 1000 | 2,1 to 68,9 | 3 to 20 | 0,2 to 1,4 | 1500 | 103,4 | 2500 | 172,4 |
| 706 | 100 to 1700 | 6,9 to 117,2 | 10 to 30 | 0,7 to 2,1 | 2000 | 103,4 | 2500 | 172,4 |

Viton® diaphragm and O-Ring with 316 stainless steel 1/4" NPT (female) pressure connection (includes adjustable deadband switch)

| | | | | | | | | |
|-------|-----------|-------------|----------|------------|-----|------|------|------|
| 15623 | 20 to 200 | 1,4 to 13,8 | 12 to 26 | 0,8 to 1,8 | 500 | 34,5 | 1000 | 68,9 |
|-------|-----------|-------------|----------|------------|-----|------|------|------|

| Model | Adjustable Set Point Range | | Adjustable Deadband | | | Over Range Pressure* | | Proof Pressure** | |
|-------|----------------------------|-----|---------------------|---------------|--------------|----------------------|-----|------------------|-----|
| | psi | bar | Low End psi | Mid Range psi | High End psi | psi | bar | psi | bar |

Buna N diaphragm and O-Ring nickel-plated brass 1/4" NPT (female) pressure connection; includes adjustable deadband microswitch

| | | | | | | | | | | | | |
|-------|-------------|--------------|----------|------------|----------|------------|-----------|------------|------|-------|------|-------|
| 15731 | 3 to 30 | 0,2 to 2,1 | 1.5 to 4 | 0,1 to 0,3 | 2 to 4.5 | 0,1 to 0,3 | 2.5 to 5 | 0,2 to 0,3 | 500 | 34,5 | 600 | 41,4 |
| 15732 | 5 to 100 | 0,3 to 6,9 | 3 to 6 | 0,2 to 0,4 | 4 to 7.5 | 0,3 to 0,5 | 5 to 9 | 0,3 to 0,6 | 500 | 34,5 | 600 | 41,4 |
| 15733 | 9 to 300 | 0,6 to 27,0 | 4 to 11 | 0,3 to 0,8 | 5 to 13 | 0,3 to 0,9 | 5 to 16 | 0,3 to 1,1 | 500 | 34,5 | 600 | 41,4 |
| 15734 | 15 to 500 | 1,0 to 34,5 | 8 to 25 | 0,6 to 1,7 | 9 to 28 | 0,6 to 1,9 | 10 to 31 | 0,7 to 2,1 | 1500 | 103,4 | 2500 | 172,4 |
| 15735 | 30 to 1000 | 2,1 to 68,9 | 9 to 30 | 0,6 to 2,1 | 10 to 35 | 0,7 to 2,4 | 30 to 90 | 2,1 to 6,2 | 1500 | 103,4 | 2500 | 172,4 |
| 15736 | 100 to 1700 | 6,9 to 117,2 | 25 to 60 | 1,7 to 4,1 | 40 to 80 | 2,8 to 5,5 | 50 to 100 | 3,4 to 6,9 | 2000 | 137,9 | 2500 | 172,4 |

| Model | Adjustable Set Point Range | | Deadband | | Over Range Pressure* | | Proof Pressure** | |
|-------|----------------------------|-----|--------------------------|------------------------|----------------------|-----|------------------|-----|
| | psi | bar | Lower 75% range span psi | Top 25% range span bar | psi | bar | psi | bar |

Welded 316 stainless steel diaphragm and 1/2" NPT (female) pressure connection, large 0.72" orifice for clean-out purposes (NACE MR-0175 compliant)

| | | | | | | | | | | |
|-----|------------|--------------|----------|------------|---------|------|------|-------|------|-------|
| 190 | 5 to 30 | 0,3 to 2,1 | 1 to 3 | 0,1 to 0,2 | 6 max | 0,4 | 1500 | 103,4 | 2500 | 172,4 |
| 191 | 10 to 100 | 0,7 to 6,9 | 1 to 8 | 0,1 to 0,6 | 15 max | 1,0 | 1500 | 103,4 | 2500 | 172,4 |
| 192 | 15 to 300 | 1,0 to 20,7 | 3 to 18 | 0,2 to 1,2 | 25 max | 1,7 | 1500 | 103,4 | 2500 | 172,4 |
| 193 | 20 to 500 | 1,4 to 34,5 | 4 to 30 | 0,3 to 2,1 | 45 max | 3,1 | 1500 | 103,4 | 2500 | 172,4 |
| 194 | 80 to 1700 | 5,5 to 117,2 | 5 to 120 | 0,3 to 8,3 | 150 max | 10,3 | 2000 | 137,9 | 2500 | 172,4 |

Application Note: The use of metallic diaphragms where higher pressure shock or heavy cycling is expected should be avoided. Models 171-174 should not be used where system or start-up vacuum pressure might exceed 26" Hg Vac (-0.9 bar).

| Model | Adjustable Set Point Range | | Deadband | | Top 25% | | Over Range Pressure* | | Proof Pressure** | |
|---|----------------------------------|----------------------------------|--------------------------------|--------------------|--------------------|------|----------------------|-------|------------------|-------|
| | Low end of range on fall; psi | High end of range on rise bar | Lower 75% range span psi | bar | range span psi | bar | psi | bar | psi | bar |
| Type H100 | | | | | | | | | | |
| Welded 316 stainless steel diaphragm and 1/2" NPT (female) pressure connection, 0.06" orifice to dampen pulsations | | | | | | | | | | |
| 490 | 5 to 30 | 0,3 to 2,1 | 1 to 3 | 0,1 to 0,2 | 6 max | 0,4 | 1500 | 103,4 | 2500 | 172,4 |
| 491 | 10 to 100 | 0,7 to 6,9 | 1 to 8 | 0,1 to 0,6 | 15 max | 1,0 | 1500 | 103,4 | 2500 | 172,4 |
| 492 | 15 to 300 | 1,0 to 20,7 | 3 to 18 | 0,2 to 1,2 | 25 max | 1,7 | 1500 | 103,4 | 2500 | 172,4 |
| 493 | 20 to 500 | 1,4 to 34,5 | 4 to 30 | 0,3 to 2,1 | 45 max | 3,1 | 1500 | 103,4 | 2500 | 172,4 |
| 494 | 80 to 1700 | 5,5 to 117,2 | 5 to 120 | 0,3 to 8,3 | 150 max | 10,3 | 2000 | 137,9 | 2500 | 172,4 |
| | psi (unless noted) | bar | psi (unless noted) | bar (unless noted) | | | psi | bar | psi | bar |
| 316L stainless steel diaphragm (optional Hastelloy® C or Monel®); Viton® GLT O-Ring (optional Kalrez®, Ethylene Propylene, or Aflas®); 316 stainless steel 1/2" NPT (female) pressure connection (optional Hastelloy® C or Monel®), large 0.72" orifice for clean-out purposes. Models 188 and 189 have a 316L stainless steel 1/2" NPT (female) pressure connection (NACE MR-0175 compliant) | | | | | | | | | | |
| 183 | 1 to 20 | 0,1 to 1,4 | 0.3 to 2.5 | | 20,7 to 172,4 mbar | | 500 | 34,5 | 1000 | 68,9 |
| 184 | 2 to 50 | 0,1 to 3,4 | 0.3 to 3 | | 20,7 to 206,8 mbar | | 500 | 34,5 | 1000 | 68,9 |
| 185 | 4 to 100 | 0,3 to 6,9 | 0.5 to 6 | | 34,5 to 413,7 mbar | | 500 | 34,5 | 1000 | 68,9 |
| 186 | 8 to 200 | 0,6 to 13,8 | 1 to 11 | | 0,1 to 0,8 | | 500 | 34,5 | 1000 | 68,9 |
| 188 | 50 to 1000 | 3,4 to 68,9 | 25 to 125 | | 1,7 to 8,6 | | 2000 | 137,9 | 7000 | 482,6 |
| 189 | 250 to 3500 | 17,2 to 241,3 | 50 to 300 | | 3,4 to 20,7 | | 4000 | 275,8 | 7000 | 482,6 |
| 316L stainless steel diaphragm (optional Hastelloy® C or Monel®); Viton® GLT O-Ring (optional Kalrez®, ethylene propylene or Aflas®); 316 stainless steel 1/2" NPT (female) pressure connection (optional Hastelloy® C or Monel®), 0.06" orifice to dampen pulsations. Models 488 and 489 316L stainless steel pressure connection (NACE MR-0175 compliant) | | | | | | | | | | |
| 483 | 1 to 20 | 0,1 to 1,4 | 0.3 to 2.5 | | 20,7 to 172,4 mbar | | 500 | 34,5 | 1000 | 68,9 |
| 484 | 2 to 50 | 0,1 to 3,4 | 0.3 to 3 | | 20,7 to 206,8 mbar | | 500 | 34,5 | 1000 | 68,9 |
| 485 | 4 to 100 | 0,3 to 6,9 | 0.5 to 6 | | 34,5 to 413,7 mbar | | 500 | 34,5 | 1000 | 68,9 |
| 486 | 8 to 200 | 0,6 to 13,8 | 1 to 11 | | 0,1 to 0,8 | | 500 | 34,5 | 1000 | 68,9 |
| 488 | 50 to 1000 | 3,4 to 68,9 | 25 to 125 | | 1,7 to 8,6 | | 2000 | 137,9 | 7000 | 482,6 |
| 489 | 250 to 3500 | 17,2 to 241,3 | 50 to 300 | | 3,4 to 20,7 | | 4000 | 275,8 | 7000 | 482,6 |
| Phosphor bronze bellows with nickel-plated brass 1/4" NPT (female) pressure connection. Model 218 has 300 series stainless steel spring exposed to media | | | | | | | | | | |
| 218 | 30 "Hg Vac to 0 | -1 to 0 | 1 to 2 "Hg | | 33,9 to 67,7 mbar | | 3 | 0,2 | 30 | 2,1 |
| 270 | 4 to 200 | 0,3 to 13,8 | 1 to 8 | | 0,1 to 0,6 | | 200 | 13,8 | 250 | 17,2 |
| 274 | 6 to 300 | 0,4 to 20,7 | 1 to 10 | | 0,1 to 0,7 | | 300 | 20,7 | 350 | 24,1 |
| Welded 316L stainless steel bellows and 1/4" NPT (female) pressure connection | | | | | | | | | | |
| 358 | 15 to 200 | 1,0 to 13,8 | 1 to 6 | | 0,1 to 0,2 | | 200 | 13,8 | 800 | 55,2 |
| 361 | 20 to 300 | 1,4 to 20,7 | 1 to 7 | | 0,1 to 0,3 | | 300 | 20,7 | 800 | 55,2 |
| 376 | 25 to 500 | 1,7 to 34,5 | 1.5 to 8 | | 0,1 to 0,3 | | 500 | 34,5 | 800 | 55,2 |

Hastelloy® is a registered trademark of Haynes International, Inc. Monel® is a registered trademark of The Special Metals Corporation. Viton® and Kalrez® are registered trademarks of E.I. duPont de Nemours and Company. Aflas® is a registered trademark of Asahi Glass.

* Over Range Pressure: The maximum pressure that may be applied continuously without causing damage and maintaining set point repeatability.

** Proof Pressure: The maximum pressure to which a pressure sensor may be occasionally subjected, which causes no permanent damage. The unit may require calibration (e.g., start-up, testing).

Deadband Note: Models 190-194, 490-494 are expressed as the lower 75% and top 25% of the range span because of the operating characteristics of the diaphragm sensor and switch. Use of optional diaphragm materials for models 483-489 may increase deadband.



PRESSURE MODEL CHART

| Model | Adjustable Set Point Range | | Deadband | | Over Range Pressure* | | Proof Pressure** | |
|--|----------------------------|---------------|-----------|-------------|----------------------|-------|------------------|-------|
| | psi | bar | psi | bar | psi | bar | psi | bar |
| Type H100 | | | | | | | | |
| 303 stainless steel piston, Buna N O-Ring with 303 stainless steel 1/4" NPT (female) pressure connection | | | | | | | | |
| 610 | 75 to 1000 | 5,2 to 68,9 | 30 to 150 | 2,1 to 10,3 | 6000 | 413,7 | 10,000 | 689,5 |
| 612 | 125 to 3000 | 8,6 to 206,8 | 40 to 250 | 2,8 to 17,2 | 6000 | 413,7 | 10,000 | 689,5 |
| 616 | 700 to 5000 | 48,3 to 344,7 | 40 to 375 | 2,8 to 25,9 | 6000 | 413,7 | 10,000 | 689,5 |
| | psi | bar | psi | bar | psi | bar | psi | bar |
| 303 stainless steel piston, Buna N O-Ring with 303 stainless steel 1/4" NPT (female) pressure connection (includes adjustable deadband switch) | | | | | | | | |
| 15884 | 700 to 5000 | 48,3 to 344,7 | 80 to 500 | 5,5 to 34,5 | 6000 | 413,7 | 10,000 | 689,5 |
| 316 stainless steel bellows and 1/4" NPT (female) pressure connection (Not recommended for rapid or high cycling pressure changes) | | | | | | | | |
| 680 | 100 to 1700 | 6,9 to 117,2 | 9 to 40 | 0,6 to 2,8 | 1700 | 117,2 | 2500 | 172,4 |

DIFFERENTIAL PRESSURE MODEL CHART

| Model | Adjustable Set Point Range | | Deadband | | Working Pressure*** | | Proof Pressure** | |
|---|----------------------------|--------------------|-----------------|------------------|---------------------|------------|------------------|-------|
| | psid | bar | psi | bar | psi | bar | psi | bar |
| Type H100K | | | | | | | | |
| Buna N diaphragm and sealing diaphragms with epoxy coated aluminum 1/8" NPT (female) pressure connections | | | | | | | | |
| 540 | 0.2 to 7 "wcd | 0,5 to 17,4 mbar | 0.05 to 0.6 "wc | 0,1 to 1,5 mbar | 30 "Hg Vac to 200 | -1 to 13,8 | 400 | 27,6 |
| 541 | 1 to 20 "wcd | 2,5 to 49,8 mbar | 0.1 to 1.0 "wc | 0,2 to 2,5 mbar | 30 "Hg Vac to 200 | -1 to 13,8 | 400 | 27,6 |
| 542 | 5 to 50 "wcd | 12,4 to 124,5 mbar | 0.2 to 2.5 "wc | 0,5 to 6,2 mbar | 30 "Hg Vac to 200 | -1 to 13,8 | 400 | 27,6 |
| 543 | 10 to 200 "wcd | 24,9 to 497,8 mbar | 0.5 to 8 "wc | 1,2 to 19,9 mbar | 30 "Hg Vac to 200 | -1 to 13,8 | 400 | 27,6 |
| 544 | 2 to 20 | 0,1 to 1,4 | 0.1 to 1.3 | 6,9 to 89,6 mbar | 30 "Hg Vac to 1200 | -1 to 82,7 | 2500 | 172,4 |
| 545 | 5 to 50 | 0,3 to 3,4 | 0.2 to 2.2 | 13,8 mbar to 0,1 | 30 "Hg Vac to 1200 | -1 to 82,7 | 2500 | 172,4 |
| 546 | 10 to 125 | 0,7 to 8,6 | 0.4 to 5.0 | 27,6 mbar to 0,3 | 30 "Hg Vac to 1200 | -1 to 82,7 | 2500 | 172,4 |
| 547 | 50 to 250 | 3,4 to 17,2 | 0.8 to 10 | 0,1 to 0,7 | 30 "Hg Vac to 1200 | -1 to 82,7 | 2500 | 172,4 |
| 548 | 100 to 500 | 6,9 to 34,5 | 2.0 to 15 | 0,1 to 1,0 | 30 "Hg Vac to 1200 | -1 to 82,7 | 2500 | 172,4 |

* Over Range Pressure: The maximum pressure that may be applied continuously without causing damage and maintaining set point repeatability.

** Proof Pressure: The maximum pressure to which a pressure sensor may be occasionally subjected, which causes no permanent damage. The unit may require calibration (e.g. start-up, testing).

***Working Pressure Range: The pressure range within which two opposing sensors can be safely operated and still maintain set point adjustability.

TEMPERATURE MODEL CHART

| Model | Adjustable Set Point Range | | Max. Temp | | Scale Division | | Stem or Bulb Size†/Finish‡‡ |
|---|----------------------------|----------------|-----------|-------|-----------------|----------------|--|
| | °F | °C | °F | °C | °F | °C | |
| Type B100 Internal adjustment via reference dial Type C100 No reference dial; model 13546 not available | | | | | | | |
| 120 | 0 to 225 | -17.8 to 107.2 | 275 | 135 | 10 [†] | 5 [†] | 9/16" x 1-7/8" below 1/2 "NPT thread (nickel-plated brass) |
| 121 | 200 to 425 | 93.3 to 218.3 | 475 | 246.1 | 10 [†] | 5 [†] | 9/16" x 1-7/8" below 1/2 "NPT thread (nickel-plated brass) |
| 13546 [†] | 15 to 140 | -9.4 to 60 | 160 | 71.1 | 5 [†] | 2 [†] | 9/16" x 2-11/16" long stainless steel (Freeze Protection) |
| Type E100 Stainless steel bulb and capillary; internal adjustment via reference dial | | | | | | | |
| 2BSA | -120 to 100 | -84.4 to 37.8 | 150 | 65.6 | 10 | 5 | 3/8 x 2-5/8" |
| 2BSB | 30 to 250 | -1.1 to 121.1 | 300 | 148.9 | 10 | 5 | 3/8 x 2-5/8" |
| 3BS | 100 to 400 | 37.8 to 204.4 | 450 | 232.2 | 10 | 5 | 3/8 x 2-1/8" |
| 4BS | 25 to 100 | -3.9 to 37.8 | 150 | 65.6 | 2 | 1 | 3/8 x 6-3/4" |
| 5BS | -20 to 80 | -28.9 to 26.7 | 130 | 54.4 | 5 | 2 | 3/8 x 5" |
| 8BS | 350 to 640 | 176.7 to 337.8 | 690 | 365.6 | 10 | 5 | 3/8 x 3-1/4" |
| 13545 | 25 to 325 | -3.9 to 162.8 | 360 | 182.2 | 10 | 5 | 1/8 x 11-5/8" (Heat Tracing) |
| Copper bulb and capillary | | | | | | | |
| 2BCA | -120 to 100 | -84.4 to 37.8 | 150 | 65.6 | 10 | 5 | 3/8 x 2-5/8" |
| 2BCB | 30 to 250 | -1.1 to 121.1 | 300 | 148.9 | 10 | 5 | 3/8 x 2-5/8" |
| 3BC | 100 to 400 | 37.8 to 204.4 | 450 | 232.2 | 10 | 5 | 3/8 x 2-1/8" |
| 4BC | 25 to 100 | -3.9 to 37.8 | 150 | 65.6 | 2 | 1 | 3/8 x 6-3/4" |
| 5BC | -20 to 80 | -28.9 to 26.7 | 130 | 54.4 | 5 | 2 | 3/8 x 5" |
| 8BC | 350 to 640 | 176.7 to 337.8 | 690 | 365.6 | 10 | 5 | 3/8 x 3-1/4" |
| Type F100 Stainless steel bulb and capillary; no reference dial | | | | | | | |
| 1BS | -180 to 120 | -117.8 to 48.9 | 170 | 76.7 | N/A | | 3/8 x 3-3/4" |
| 2BS | -125 to 350 | -87.2 to 176.7 | 400 | 204.4 | N/A | | 3/8 x 2-5/8" |
| 3BS | -125 to 500 | -87.2 to 260 | 550 | 287.8 | N/A | | 3/8 x 2-1/8" |
| 4BS | -40 to 120 | -40 to 48.9 | 170 | 76.7 | N/A | | 3/8 x 6-3/4" |
| 5BS | -40 to 180 | -40 to 82.2 | 230 | 110 | N/A | | 3/8 x 5" |
| 6BS | 0 to 250 | -17.8 to 121.1 | 300 | 148.9 | N/A | | 3/8 x 4-1/2" |
| 7BS | 0 to 400 | -17.8 to 204.4 | 450 | 232.2 | N/A | | 3/8 x 3" |
| 8BS | 50 to 650 | 10 to 343.3 | 700 | 371.1 | N/A | | 3/8 x 3-1/4" |
| Copper bulb and capillary | | | | | | | |
| 1BC | -180 to 120 | -117.8 to 48.9 | 170 | 76.7 | N/A | | 3/8 x 3-3/4" |
| 2BC | -125 to 350 | -87.2 to 176.7 | 400 | 204.4 | N/A | | 3/8 x 2-5/8" |
| 3BC | -125 to 500 | -87.2 to 260 | 550 | 287.8 | N/A | | 3/8 x 2-1/8" |
| 4BC | -40 to 120 | -40 to 48.9 | 170 | 76.7 | N/A | | 3/8 x 6-3/4" |
| 5BC | -40 to 180 | -40 to 82.2 | 230 | 110 | N/A | | 3/8 x 5" |
| 6BC | 0 to 250 | -17.8 to 121.1 | 300 | 148.9 | N/A | | 3/8 x 4-1/2" |
| 7BC | 0 to 400 | -17.8 to 204.4 | 450 | 232.2 | N/A | | 3/8 x 3" |
| 8BC | 50 to 650 | 10 to 343.3 | 700 | 371.1 | N/A | | 3/8 x 3-1/4" |

†Type B100 only

‡Optional immersion stem lengths and capillary lengths are available. Standard capillary length is 6 ft except models 13545 which is 10 ft.

‡‡Optional stainless steel immersion stem, and armored capillary covering available.



HOW TO ORDER

BUILDING A PART NUMBER

Select a **Type**

Refer to the "Type" section below.
 Determine type number based on switch output, enclosure, adjustment and reference.
 Fill in the type portion of your part number with the corresponding number.

Select a **Model**

Refer to the "Model Charts".
 Determine model based on adjustable range, deadband and proof pressure.
 Fill in the model portion of your part number with the corresponding number.

Select an **Option**

Refer to the "Options" section.
 Determine option number based on switch output, optional materials or other product enhancements.
 Fill in the option portion of your part number with the corresponding number.
 Leave "option" portion blank if no options are needed.
 FOR MULTIPLE OPTIONS: Call United Electric Controls.

TYPE

DESCRIPTION

PRESSURE

Type H100 - One SPDT output; epoxy coated enclosure; internal adjustment with "High-Low" reference scale

DIFFERENTIAL PRESSURE

Type H100K - One SPDT output; epoxy coated enclosure; internal adjustment with "High-Low" reference scale

TEMPERATURE

Type B100 - Immersion stem; one SPDT output; internal adjustment with reference dial
 Type C100 - Immersion stem; one SPDT output; internal adjustment with no reference
 Type E100 - Bulb and capillary; one SPDT output; internal adjustment with reference dial
 Type F100 - Bulb and capillary; one SPDT output; internal adjustment with no reference

SWITCH OPTIONS*

| | |
|------|---|
| 0140 | Gold contacts, 1A 125 VAC resistive. NOT AVAILABLE MODELS 13545, 13546, 15623, 15731-15884 |
| 0500 | Close deadband, 5A 125/250 VAC resistive. NOT AVAILABLE MODELS 520-535, 13545, 13546, 15623, 15731-15884 |
| 1010 | DPDT switch, 10A 125/250 VAC resistive; deadband and minimum set point will increase. NOT AVAILABLE TEMPERATURE VERSIONS, TYPE H100K OR MODELS 171-194, 483-567, 680, 15623, AND 15731-15884 |
| 1070 | 10 A 125 VDC resistive; deadband and minimum set point will increase. NOT AVAILABLE MODELS 171-194, 483-535, 560-567, 13545, 13546, 15623, 15731-15884 |
| 1519 | Adjustable deadband, 15 A 125/250/480 VAC resistive; adjustment wheel changes rise setting only. If adjustment on fall setting is required, use primary adjustment. NOT AVAILABLE TYPES B100, E100 OR MODELS 171-194, 483-494, 560-567, 610-616, 51623, 15731-15884 |
| 1530 | External manual reset, 15 A 125/250/480 VAC resistive; latches on rise, only. NOT AVAILABLE MODELS 13545, 13546, 15623, 15731-15884 |
| 1535 | High ambient, 15 A 125/250 VAC resistive; temperatures up to 250°F (121.1°C). NOT AVAILABLE MODELS 520-535, 13545, 13546, 15623, 15731-15884 |
| 1537 | Vapor sealed switch, 15 A 125/250 VAC resistive. NOT AVAILABLE MODELS 523, 533, 13545, 13546, 15623, 15731-15884 |
| 2000 | 20 A 125/250/480 VAC resistive. NOT AVAILABLE TYPE H100K OR MODELS 520-535, 13545, 13546, 15623, 15731-15884 |
| 3000 | 30 A 125/250/277 VAC resistive. NOT AVAILABLE TYPE H100K OR MODELS 171-194, 483-567, 680, 13545, 13546, 15623, 15731-15884 |

* All switches have limited DC capabilities. Consult factory for details.

OTHER OPTIONS

| | |
|------------------------|---|
| M020 | Red status light, 115 VAC only. NOT AVAILABLE MODELS 13545, 13546, 15623, 15731-15884 |
| M201 | Factory set one switch; specify increasing or decreasing pressure or temperature and setpoint |
| M277 | Range indicated on nameplate in kPa or MPa, factory selected. NOT AVAILABLE ON TEMPERATURE VERSIONS |
| M278 | Range indicated on nameplate in Kg/cm ² . NOT AVAILABLE ON TEMPERATURE VERSIONS |
| M405 | Intrinsic safety compliance for European Union per ATEX standards |
| M406 | Intrinsic Safety compliance for Russia per Gosgortekhnadzor standards. |
| M444 | Paper ID tag |
| M446 | Stainless steel ID tag & wire attachment |
| M449 | Surface mounting hardware kit that is required for models 520-535, 15737, & 540-548 when surface mounting. Use option code only at time of ordering product, otherwise use surface and pipe mounting kit part number 6361-704 as a separate order or for other models. |
| M504 | 316L stainless steel immersion stem. AVAILABLE TEMPERATURE MODELS 120, 121 ONLY |
| M540 | Viton® construction (deadband and low end range may increase slightly); wetted parts include Viton® diaphragm and O-ring plus stainless steel pressure connection. AVAILABLE ON MODELS 610-616 (O-ring only), 701-705 (Viton diaphragm & O-ring, stainless steel pressure connection), AND 540-548 (Viton diaphragms and seals, pressure connections remain aluminum) |
| M550 | Oxygen service cleaning; alcohol cleaning to remove residue from the process connection. NOT AVAILABLE ON PRESSURE MODEL 706 |
| M914 | 1/2" NPT (female) stainless steel pressure connection. AVAILABLE MODELS 358-376, 610-616 |
| M921 | Brass pressure connection. AVAILABLE MODELS 610-616 |
| 6361-704 | Surface and pipe mounting hardware kit for all models. Required for surface mounting models 520-535, 15737 & 540-548 if not previously ordered with option M449. |
| SD6286-51 | Watertight conduit fitting; connects 7/8" hole to 1/2" NPT (female) fitting |
| ALSO AVAILABLE: | UE Final Inspection Reports, Certified Drawings, and other Certificates are available. Please consult your UE representative for additional information. |

OPTIONAL SENSOR MATERIAL FOR "WC RANGES. AVAILABLE MODELS 520-525

| | |
|-------|---|
| XC001 | Aluminum pressure connection, Viton® diaphragm, Viton® O-ring |
| XC002 | Aluminum pressure connection, Kapton® diaphragm, Buna N O-ring |
| XC003 | Aluminum pressure connection, Kapton® diaphragm, Viton® O-ring |
| XC004 | 316L Stainless steel pressure connection, 316L stainless steel diaphragm, Viton® O-ring. (Over range pressure is limited to 100 psi) |
| XC005 | 316L Stainless steel pressure connection, Viton® diaphragm, Viton® O-ring |
| XC007 | 316L Stainless steel pressure connection, Teflon® diaphragm, Viton® O-ring |

OPTIONAL SENSOR MATERIALS FOR CORROSIVE MEDIA. AVAILABLE MODELS 183-189, 483-489

| | |
|-------|--|
| XD002 | Hastelloy C diaphragm (NACE MR-0175 compliant) |
| XD003 | Monel diaphragm (NACE MR-0175 compliant) |
| XP112 | Hastelloy C pressure connection (NACE MR-0175 compliant) |
| XP113 | Monel pressure connection (NACE MR-0175 compliant) |
| XR211 | Kalrez® O-ring |
| XR213 | Ethylene propylene O-ring |
| XR214 | Aflas® O-ring |

OPTIONAL FLUSH MOUNT FLANGES. AVAILABLE MODELS 560-567

| | | |
|------|---|-------------------------------|
| F196 | Flush mounted flange, 150#, 1" lap joint, raised face | AVAILABLE MODELS 565-567 ONLY |
| F197 | Flush mounted flange, 150#, 2" lap joint, raised face | AVAILABLE MODELS 560-564 ONLY |
| F198 | Flush mounted flange, 300#, 1" lap joint, raised face | AVAILABLE MODELS 565-567 ONLY |
| F199 | Flush mounted flange, 300#, 2" lap joint, raised face | AVAILABLE MODELS 560-564 ONLY |

Note: No options are available on Heat Trace and Freeze Protection models 13546 and 13545 or pump switch models 15623 & 15731-15737 except M201, M405, M406 M444, M446 and M550. No options are available on model 15884 except M201 & M446.



OPTIONS FOR TEMPERATURE MODELS

UNION CONNECTORS**

| Option | Replacement Number | Description |
|--------|----------------------------|--------------------------|
| | <u>Brass</u> | |
| W027 | SD6213-27 | 1/2" NPT w/ 3/4" bushing |
| W045 | SD6213-45 | 3/4" NPT |
| W051 | SD6213-51 | 1/2" NPT |
| | <u>304 Stainless Steel</u> | |
| W028 | SD6213-28 | 1/2" NPT w/ 3/4" bushing |
| W046 | SD6213-46 | 3/4" NPT |
| W050 | SD6213-50 | 1/2" NPT |

THERMOWELLS**

For all bulb & capillary switches, except Model 13545

| Option | Replacement Number | Description |
|--------|----------------------------|---|
| | <u>Brass</u> | |
| W075 | SD6225-75 | 1/2" NPT with 3/4" NPT adapter bushing, 4" BT |
| W191 | SD6225-191 | 1/2" NPT, 4" BT |
| W118 | SD6225-118 | 1/2" NPT with 3/4" NPT adapter bushing, 7" BT |
| W192 | SD6225-192 | 1/2" NPT, 7" BT |
| | <u>316 Stainless Steel</u> | |
| W076 | SD6225-76 | 3/4" NPT, 4.5" BT |
| W193 | SD6225-193 | 1/2" NPT, 4.5" BT |
| W119 | SD6225-119 | 3/4" NPT, 7.5" BT |
| W177 | SD6225-177 | 1/2" NPT, 7.5" BT |

For all immersion stem switches; except Model 13546

| | | |
|------|------------|-----------------------------------|
| W139 | SD6225-139 | 3/4" NPT X 1-23/32" BT, BRASS |
| W140 | SD6225-140 | 3/4" NPT X 1-23/32" BT, 316 ST/ST |

W000 IMMERSION STEM AND THERMOWELLS

Note: Option W000 is a special Immersion Stem construction that has no external thread. This option fits inside a special thermowell and is secured with a set-screw.

| Option | Description |
|--------|--|
| W000 | Immersion stem only, brass |
| W097 | Immersion stem and thermowell. Includes W000 stem and 1/2" NPT x 1-23/32" BT Brass thermowell |
| W099 | Immersion stem and thermowell. Includes W000 stem and 1/2" NPT x 1-23/32" BT 316 ST/ST thermowell. |

OPTIONAL LENGTHS:

Optional immersion stem lengths to 15" may be available in Brass, with or without 316 ST/ST thermowell. Consult UE for additional information and availability. Optional capillary length to *50' may be available in Copper or 304 ST/ST. Armor or Teflon® capillary protection may be available to lengths less than or equal to capillary length. Consult UE for additional information and availability.

*Consult UE regarding repeatability and ambient effects on capillary lengths over 30'.
** Dimensional drawings for union connectors and thermowells may be found at www.ueonline.com

DIMENSIONAL DRAWINGS

Dimensional drawings for all models may be found at www.ueonline.com

Types B100, C100, E100, F100, H100, H100K

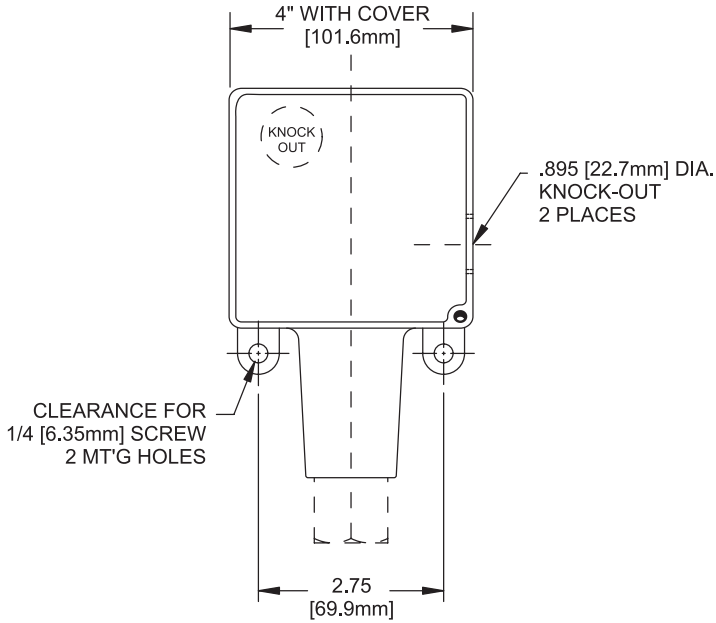
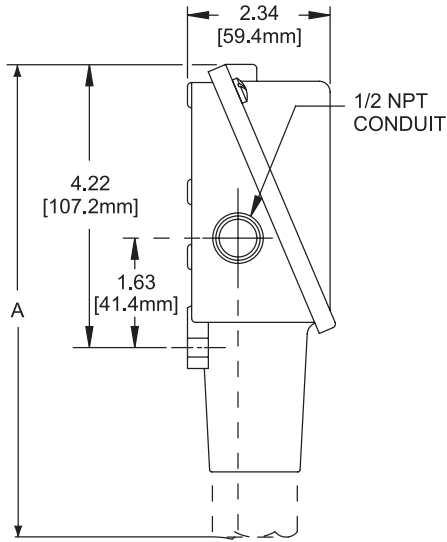

| Dimension A | | | |
|------------------------------|--------|-------|-------------------------|
| Models | Inches | mm | NPT |
| Pressure | | | |
| 171-174 | 7.63 | 193.8 | 1/2" |
| 183-186, 484-486 | 7.56 | 192.0 | 1/2" |
| 188-189, 488-489 | 6.63 | 168.4 | 1/2" |
| 190-194, 490-494 | 6.63 | 168.4 | 1/2" |
| 218 | 6.56 | 166.6 | 1/4" |
| 270-274 | 7.00 | 177.8 | 1/4" |
| 358-376 | 7.00 | 177.8 | 1/4" |
| 520-525, 15737 | 8.44 | 214.4 | 1/2" |
| 530-535 | 8.00 | 203.2 | 1/2" |
| 560-564 | 6.63 | 168.4 | 2" Sanitary Fitting |
| 565-567 | 6.63 | 168.4 | 1-1/2" Sanitary Fitting |
| 610-616, 680, 15884 | 7.00 | 177.8 | 1/4" |
| 701-706, 15623, 15731-15736 | 6.63 | 168.4 | 1/4" |
| Differential Pressure | | | |
| 540-543 | 8.47 | 215.1 | 1/8" |
| 544-548 | 8.53 | 216.7 | 1/8" |
| Temperature | | | |
| 120, 121, 13546 | 9.38 | 238.3 | Immersion stem |
| 1BC-8BC, 1BS-8BS, 13545 | 8.69 | 220.7 | Bulb & capillary |

All dimensions stated in inches (millimeters)

DIMENSIONAL DRAWINGS

Temperature Sensors

Models 1BC-8BC, 1BS-8BS, 13545

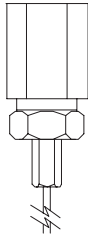

Models 120,121

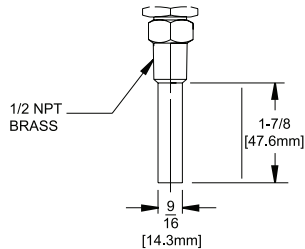

Model 13546

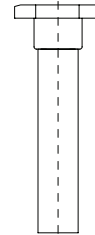

Pressure Sensors

Models 171-174

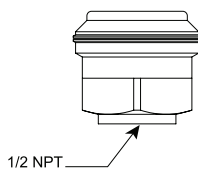

Models 183-186, 483-486

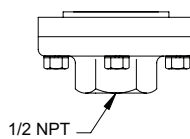

Models 188-194, 488-494

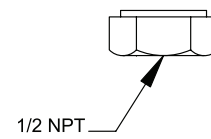

Models 218-376, 610-706, 15623, 15731-15736

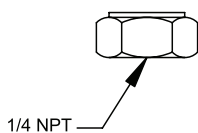

Models 520-525, 15737

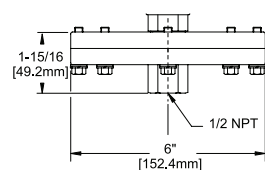

Models 530-535

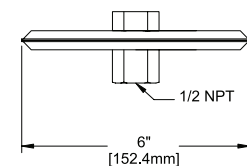

Models 540-543

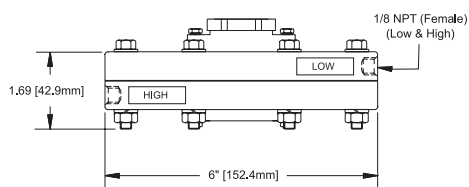

Models 544-548

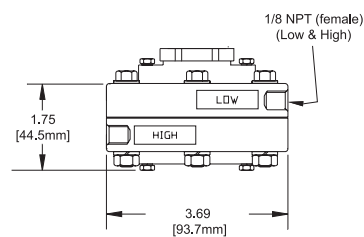

Models 560-564

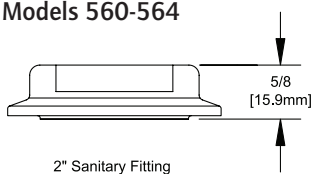

Models 565-567

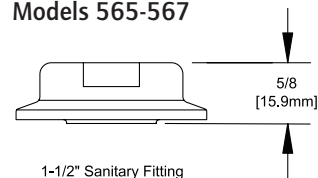

All dimensions stated in inches (millimeters)

ALTERNATIVE PRODUCTS FROM UE

One Series

- Electronic solid-state reliability
- Two-wire operation
- Digital display with keypad set-up
- 100% of range adjustable on-off deadband
- 4-20 mA output models
- Continuous diagnostic health check



10 Series

- Compact, cylindrical enclosure
- Pressure ranges from 4 to 7,500 psi, and proof pressure to 12,000 psi
- Choice of seven electrical terminations
- NPT or SAE threaded pressure connections



117 Series

- Single Switch for Corrosive and Hazardous Division 2 Locations
- Compact pressure, differential pressure and temperature models
- Hermetically-sealed SPDT and DPDT output
- Epoxy-coated weather-tight design houses stainless steel internal construction
- Convenient terminal block wiring



400 Series

- 1, 2, and 3 switch output may be separated up to 100% of range
- Wide selection of pressure, differential pressure, and temperature ranges
- Setting via reference dial or hex screw adjustment
- Weathertight 4X design ideal for ordinary location applications

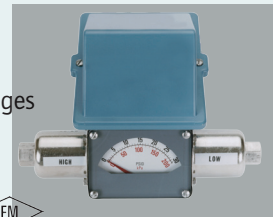

Temperature Sensors

Rugged RTDs and thermocouples for process and energy applications, available with Nema 4X and explosion-proof heads to match heat-trace, turbine, combustion, and stack-emission applications



RECOMMENDED PRACTICES AND WARNINGS

United Electric Controls Company recommends careful consideration of the following factors when specifying and installing UE pressure and temperature units. Before installing a unit, the Installation and Maintenance instructions provided with unit must be read and understood.

- To avoid damaging unit, proof pressure and maximum temperature limits stated in literature and on nameplates must never be exceeded, even by surges in the system. Operation of the unit up to maximum pressure or temperature is acceptable on a limited basis (e.g., start-up, testing) but continuous operation must be restricted to the designated over range pressure. Excessive cycling at maximum pressure or temperature limits could reduce sensor life.
- A back-up unit is necessary for applications where damage to a primary unit could endanger life, limb or property. A high or low limit switch is necessary for applications where a dangerous runaway condition could result.
- The adjustable range must be selected so that incorrect, inadvertent or malicious setting at any range point cannot result in an unsafe system condition.
- Install unit where shock, vibration and ambient temperature fluctuations will not damage unit or affect operation. When applicable, orient unit so that moisture does not enter the enclosure via the electrical connection. When appropriate, this entry point should be sealed to prevent moisture entry.
- Unit must not be altered or modified after shipment. Consult UE if modification is necessary.
- Monitor operation to observe warning signs of possible damage to unit, such as drift in set point or faulty display. Check unit immediately.
- Preventative maintenance and periodic testing is necessary for critical applications where damage could endanger property or personnel.
- Electrical ratings stated in literature and on nameplate must not be exceeded. Overload on a switch can cause damage, even on the first cycle. Wire unit according to local and national electrical codes, using wire size recommended in installation sheet.
- Do not mount unit in ambient temp. exceeding published limits.

LIMITED WARRANTY

Seller warrants that the product hereby purchased is, upon delivery, free from defects in material and workmanship and that any such product which is found to be defective in such workmanship or material will be repaired or replaced by Seller (Ex-works, Factory, Watertown, Massachusetts. INCOTERMS); provided, however, that this warranty applies only to equipment found to be so defective within a period of 24 months from the date of manufacture by the Seller. Seller shall not be obligated under this warranty for alleged defects which examination discloses are due to tampering, misuse, neglect, improper storage, and in any case where products are disassembled by anyone other than authorized Seller's representatives. EXCEPT FOR THE LIMITED WARRANTY OF REPAIR AND REPLACEMENT STATED ABOVE, SELLER DISCLAIMS ALL WARRANTIES WHATSOEVER WITH RESPECT TO THE PRODUCT, INCLUDING ALL IMPLIED WARRANTIES OF MERCHANTABILITY OR FITNESS FOR ANY PARTICULAR PURPOSE.

LIMITATION OF SELLER'S LIABILITY

SELLER'S LIABILITY TO BUYER FOR ANY LOSS OR CLAIM, INCLUDING LIABILITY INCURRED IN CONNECTION WITH (I) BREACH OF ANY WARRANTY WHATSOEVER, EXPRESSED OR IMPLIED, (II) A BREACH OF CONTRACT, (III) A NEGLIGENT ACT OR ACTS (OR NEGLIGENT FAILURE TO ACT) COMMITTED BY SELLER, OR (IV) AN ACT FOR WHICH STRICT LIABILITY WILL BE INPUTTED TO SELLER, IS LIMITED TO THE "LIMITED WARRANTY" OF REPAIR AND/OR REPLACEMENT AS SO STATED IN OUR WARRANTY OF PRODUCT. IN NO EVENT SHALL THE SELLER BE LIABLE FOR ANY SPECIAL, INDIRECT, CONSEQUENTIAL OR OTHER DAMAGES OF A LIKE GENERAL NATURE, INCLUDING, WITHOUT LIMITATION, LOSS OF PROFITS OR PRODUCTION, OR LOSS OR EXPENSES OF ANY NATURE INCURRED BY THE BUYER OR ANY THIRD PARTY.

UE specifications subject to change without notice.

FOR A LIST OF OUR INTERNATIONAL AND DOMESTIC
REGIONAL SALES OFFICES PLEASE VISIT OUR
WEBPAGE WWW.UEONLINE.COM

