

LIFT-O-MAT gas springs

LIFT-O-MAT gas springs are non-locking gas springs. They are used whenever components must be brought conveniently into a defined end position. A LIFT-O-MAT can control the extension force and damping action depending on the function, ensuring user-friendly motion sequences.

Areas of application are doors and flaps in mechanical engineering and process technology, the automotive sector, medical technology, the furniture industry and many other applications.

Advantages and properties:

- Optimized weight compensation during lifting, lowering, opening, and closing actions
- Broad range of sizes and force variants available as standard products

- Dynamic and hydraulic damping available
- Flat spring characteristic curve; i.e., low force increase, even with high forces and large strokes
- Choice of linear, progressive, or decreasing spring characteristic curves
- Compact form factor for installation in small spaces
- Large variety of end fittings for efficient assembly
- Dampened adjustment motion over defined ranges or continuously
- Extension speed control possible
- Additional functions, such as electric switches, STOP function, holding in place, etc. can be integrated

LIFT-O-MAT Gasfedern

Bei den LIFT-O-MAT Gasfedern handelt es sich um nicht-blockierbare Gasfedern. Sie kommen überall da zum Einsatz, wo ein Bauteil komfortabel in definierte Endlagen bewegt werden soll. Ein LIFT-O-MAT kann die Ausschubkraft und Dämpfung funktionsgerecht steuern und sorgt für anwenderfreundliche Bewegungsabläufe.

Einsatzgebiete sind u.a. Klappen und Türen im Maschinen- und Anlagenbau, im Fahrzeugbereich, in der Medizintechnik, der Möbelbranche u.v.m.

Vorteile und Eigenschaften:

- Optimaler Gewichtsausgleich beim Heben, Senken, Öffnen und Schließen
- Große Auswahl an Größen und Kraftvarianten im Standardprogramm

- Dynamisch und hydraulisch gedämpfte Varianten erhältlich
- Flache Federkennung, d.h. geringer Kraftanstieg auch bei hohen Kräften bzw. großen Hüben
- Lineare, progressive oder degressive Federkennlinie möglich
- Kompakte Bauart für geringsten Platzbedarf
- Vielzahl von Anschlüssen für rationelle Montage
- Dämpfen der Verstellbewegung in definierten Bereichen oder durchgehend
- Steuerung der Ausschubgeschwindigkeit möglich
- Zusatzfunktionen wie elektrische Schalter, STOP-Funktion, Haltefunktion usw. sind integrierbar

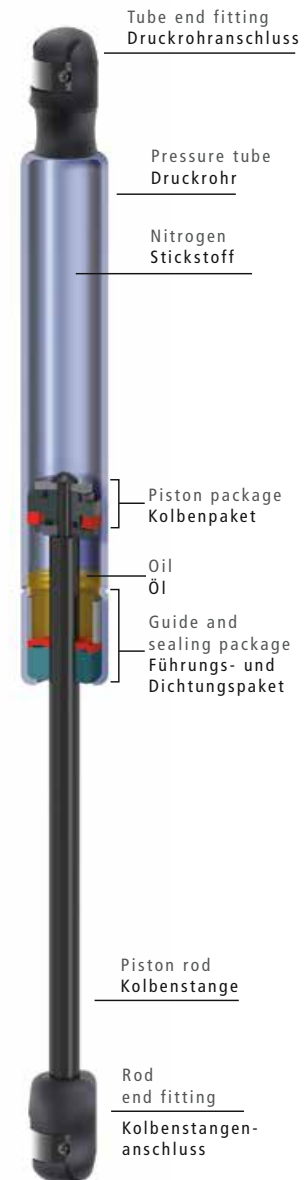

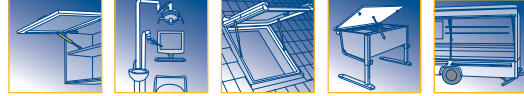

LIFT-O-MAT specialty types

1 LIFT-O-MAT FR – for infinitely variable holding in place
The LIFT-O-MAT FR is a gas spring featuring a special piston package with an integrated friction element, which – in addition to force assist – allows infinitely variable holding over the entire adjustment range. Even weight fluctuations between defined limits, for example due to varying loads, can be offset.

2 HYDRO-LIFT
The HYDRO-LIFT features a valve in its piston, which, in addition to user-optimized force assist, allows infinitely variable positioning. Depending on the design of the HYDRO-LIFT, the hold function can be active across the entire adjustment range or in one or more partial sectors of the application.

3 INTER-STOP with holding range
The INTER-STOP gas spring combines the properties of the LIFT-O-MAT with dynamic damping and the holding force working in the extension direction. The stroke can be divided into two or more function areas. For example, one function area might perform the stopping or hold the application load in any position, until a manual force is applied, for example by hand.

4 LIFT-O-MAT – with end position locking
In addition to force support, the LIFT-O-MAT gas spring with end position locking also provides a safe mechanical lock for the application in the extended position. Generally, two variations are available: Gas springs with the lock on the outside or gas springs with the lock on the inside.

5 LIFT-O-MAT – with decreasing or progressive spring characteristic curve
LIFT-O-MAT gas springs with additional coil springs will cause very high or very low spring forces in the end positions, depending on installation orientation. Depending on the application or requirement, rubber cushions or coil springs are used to achieve a very gentle end stop, adding to the gas spring effect. The coil spring length and force can be optimized for the application.

Die LIFT-O-MAT Sondertypen

1 LIFT-O-MAT FR – zum stufenlosen Halten
Der LIFT-O-MAT FR ist eine Gasfeder, die durch ein spezielles Kolbenpaket mit integriertem Reibelement zusätzlich zur Kraftunterstützung ein stufenloses Halten im gesamten Verstellbereich zulässt. Auch Gewichtsschwankungen innerhalb definierter Grenzen können aufgefangen werden.

2 HYDRO-LIFT
Der HYDRO-LIFT ist im Kolben mit einem Ventil ausgestattet, das neben der anwendungsoptimierten Kraftunterstützung eine stufenlose Positionierung zulässt. Je nach Auslegung des HYDRO-LIFT kann die Haltefunktion im gesamten Verstellbereich bzw. in einem oder mehreren Teilbereichen der Anwendung erfolgen.

3 INTER-STOP – mit Haltebereich
In der INTER-STOP Gasfeder sind die Eigenschaften des dynamisch gedämpften LIFT-O-MAT mit den Haltefunktionen des HYDRO-LIFT kombiniert, wobei die Haltekraft hier in Ausschubrichtung wirkt. Der Hub kann in zwei oder mehrere Funktionsbereiche aufgeteilt werden. So kann ein Funktionsbereich stoppen bzw. die Last der Anwendung in jeder beliebigen Position halten, bis eine manuelle Kraft, z.B. Handkraft, angelegt wird.

4 LIFT-O-MAT – mit Endlagenarretierung
Die LIFT-O-MAT Gasfeder mit Endlagenarretierung bietet zusätzlich zur Kraftunterstützung eine sichere, mechanische Verriegelung der Anwendung in ausgeschobener

Position. Grundsätzlich stehen hier zwei Varianten zur Auswahl: Gasfedern mit außen liegender oder innen liegender Arretierung.

5 LIFT-O-MAT – mit degressiver oder progressiver Federkennlinie
LIFT-O-MAT Gasfedern mit zusätzlicher Verwendung von Schraubenfedern bewirken, je nach Einbauweise, besonders große bzw. besonders kleine Federkräfte in den Endlagen. Entsprechend der Anwendung bzw. Anforderung werden Gummipuffer oder Schraubenfedern eingesetzt, um zusätzlich zur Wirkung der Gasfeder einen besonders sanften Endanschlag zu erreichen. Anwendungsspezifisch sind Schraubenfederlänge und -kraft optimal variierbar.

LIFT-O-MAT®

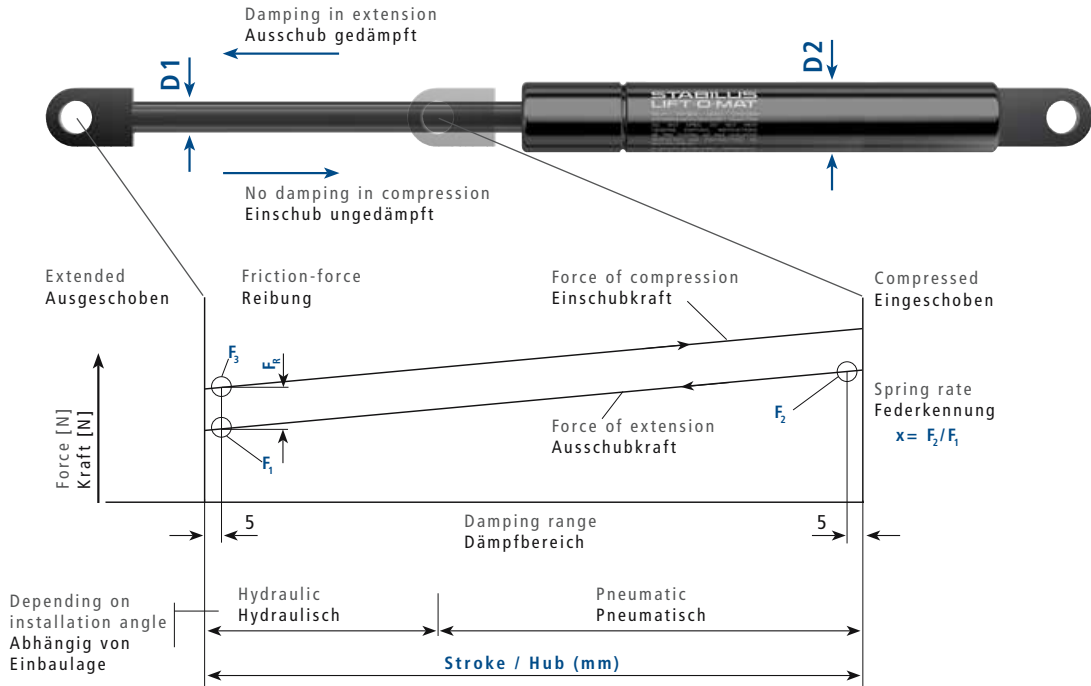

D1 [mm]	D2 [mm]	Force of extension Ausschubkraft F_1 [N]	Stroke max. Hub [mm]	x (\approx)	F_R max. [N]
6	15	50 - 400	150	1,30	50
8	19	100 - 800	250	1,35	60
10	22	150 - 1150	400	1,40	80
14	28	500 - 2100	500	1,50	80
20	42	2400 - 5200	500	1,45	150

Installation instruction
Einbauvorschrift
STAB-Spec. 1000 5593

Statically measured forces
Statische Messung der Kräfte
STAB-Spec. 1000 9033

Disposal instruction
Entsorgungsvorschrift
STAB-Spec. 1000 9375
www.Stabilus.com/service-spare-parts/recycling/
www.Stabilus.de/service-ersatzteile/recycling/

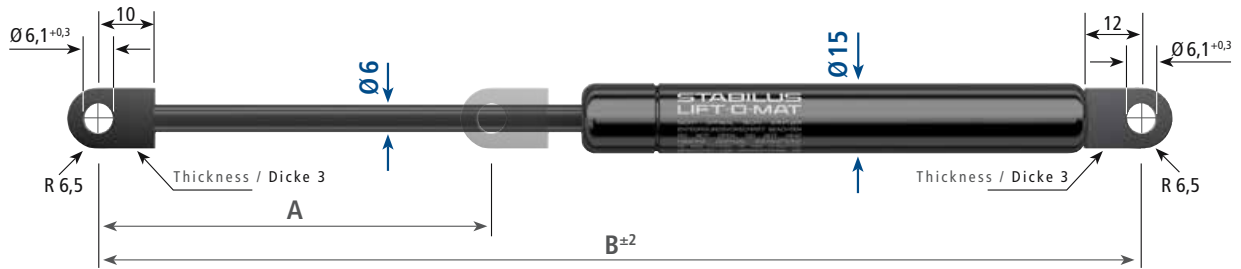



A		B	
Stroke Hub	Extended length Ausgesch. Länge	Force / Kraft F _r [N]	Ref.-No. Bestell-Nr.
20	106,5	50	192910
		100	192929
		150	192937
		200	192945
		250	192953
		300	192961
		350	192988
		400	192996
40	145,5	50	185175
		100	191752
		150	192805
		200	192813
		250	192821
		300	082309
		350	082317
		400	094307
60	185,5	50	192848
		100	192856
		150	192864
		200	192872
		250	192880
		300	082384
		350	082392
		400	094315
80	226,5	50	082406
		100	082414
		150	082422
		200	082430
		250	082449
		300	082457
		350	082465
		400	094323

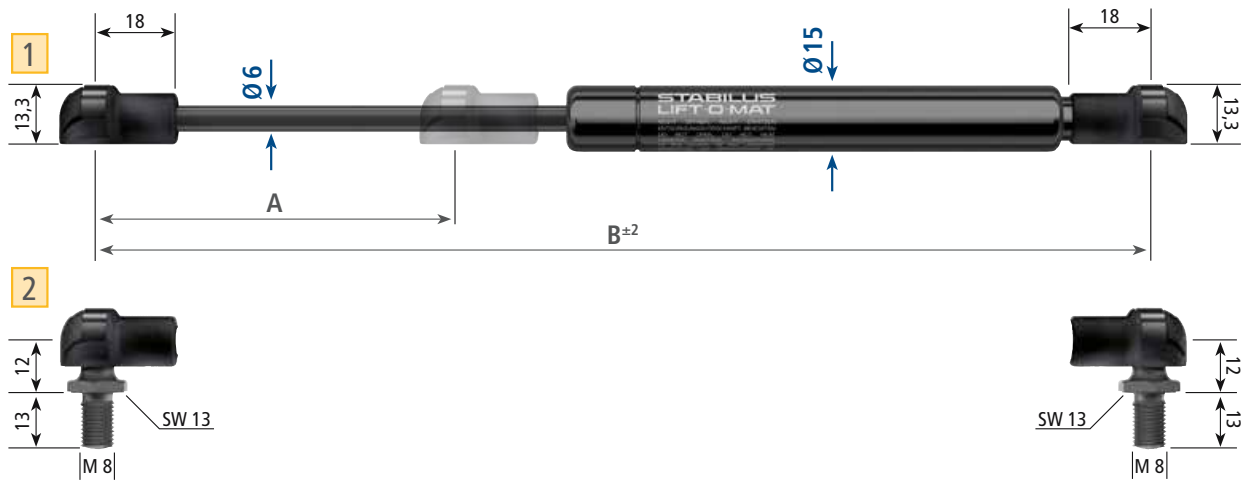

A		B	
Stroke Hub	Extended length Ausgesch. Länge	Force / Kraft F _r [N]	Ref.-No. Bestell-Nr.
100	265,5	50	082473
		100	082481
		150	082503
		200	082511
		250	082538
		300	082546
		350	082554
		400	094331
120	305,5	50	082562
		100	082570
		150	082589
		200	082597
		250	082600
		300	082627
		350	082635
		400	094358
150	365,5	50	082643
		100	082651
		150	082678
		200	082686
		250	082694
		300	082708
		350	082716
		400	6756RS

LIFT-O-MAT®



Suitable for ball studs according to DIN 71803 Ø 10
 Passend für Kugelzapfen nach DIN 71803 Ø 10

A	B	Force / Kraft F _i [N]	 	
			1 Ref.-No. Bestell-Nr.	2 Ref.-No. Bestell-Nr.
20	115,5	50	4727PB	4829DF
		100	4728PX	4832DH
		150	4729PS	4834DY
		200	4731PZ	1324DI
		250	4732PU	4836DO
		300	4733PP	4838DE
		350	4734PK	4842DB
		400	4735PF	4844DS
40	155,5	50	2606NW	4846DI
		100	2607NR	4848DZ
		150	2608NM	4851DA
		200	2609NH	1338DJ
		250	2611NO	4853DR
		300	2612NJ	4855DH
		350	2613NE	4857DY
		400	2615NV	4859DO
60	195,5	50	6444IK	4862DQ
		100	6488IU	4534DS
		150	6489IP	4904DI
		200	6491IW	1345DS
		250	6492IR	4906DZ
		300	6493IM	4908DP
		350	6494IH	4911DR
		400	6495IC	4913DH
80	235,5	50	6449IM	4915DY
		100	6501IP	4917DO
		150	6502IK	4919DE
		200	6503IF	1395DP
		250	6504IA	4922DG
		300	6505IW	4924DX
		350	6506IR	4926DN
		400	6507IM	4928DD

A	B	Force / Kraft F _i [N]	 	
			1 Ref.-No. Bestell-Nr.	2 Ref.-No. Bestell-Nr.
100	275,5	50	6458IL	4931DF
		100	6508IH	4933DW
		150	6509IC	4935DM
		200	6511IJ	1406DD
		250	6514IV	5004DJ
		300	6515IQ	5007DV
		350	6516IL	5009DL
		400	6517IG	5012DN
120	315,5	50	6462II	5025DT
		100	6519IX	5027DJ
		150	6521ID	5031DG
		200	6522IZ	1515DW
		250	6523IU	5033DX
		300	6524IP	5035DN
		350	6525IK	5037DD
		400	6526IF	5069DC
150	375,5	50	6467IK	5072DE
		100	6539IL	5075DQ
		150	6541IS	5077DG
		200	6542IN	1562DH
		250	6543II	5079DX
		300	6544ID	5082DZ
		350	6545IZ	5084DP
		400	6153PC	1205RU

We reserve the right to make modifications. Dimensions in mm.
 Änderungen vorbehalten. Maßangaben in mm.

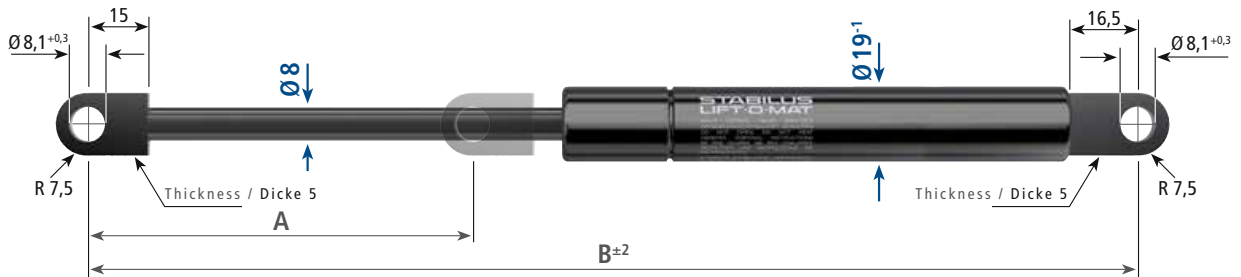

A		B		
Stroke Hub	Extended length Ausgesch. Länge	Force / Kraft F, [N]	Ref.-No. Bestell-Nr.	
60	205	500	084018	
		600	084026	
	205,5	700	084034	
		800	094684	
80	245	500	084093	
		600	084107	
		700	084115	
245,5	800	094692		
	100	285	500	084174
		600	084182	
285,5	700	084190		
	800	094706		
120	325	500	084247	
		600	094714	
		700	084263	
325,5	800	094722		
	140	365	400	084352
		500	084360	
600		084379		
365,5	700	084387		
	800	094749		
160	405	100	084395	
		150	094765	
		200	084409	
		250	094773	
		300	084417	
		350	094781	
		400	084425	
		500	084476	
		600	084484	
	405,5	700	084492	
		800	094757	
180	445	100	084506	
		150	094803	
		200	084514	
		250	094811	
		300	084522	
		350	094838	
		400	086363	
		500	084549	
		600	084557	
	445,5	700	084565	
		800	094846	

A		B	
Stroke Hub	Extended length Ausgesch. Länge	Force / Kraft F, [N]	Ref.-No. Bestell-Nr.
200	485	100	084573
		150	094854
		200	084581
		250	094862
		300	084603
		350	094870
		400	084611
		500	084638
		600	084646
	485,5	700	084654
		800	094889
220	525	100	084662
		150	094897
		200	084670
		250	094900
		300	084689
		350	094919
		400	084697
		500	084700
		600	084719
	525,5	700	084727
		800	094927
250	585	100	084735
		150	094935
		200	084743
		250	094943
		300	084751
		350	094951
		400	084778
		500	084786
		600	084794
	585,5	700	084808
		800	094978

We reserve the right to make modifications. Dimensions in mm.
Änderungen vorbehalten. Maßangaben in mm.

LIFT-O-MAT®

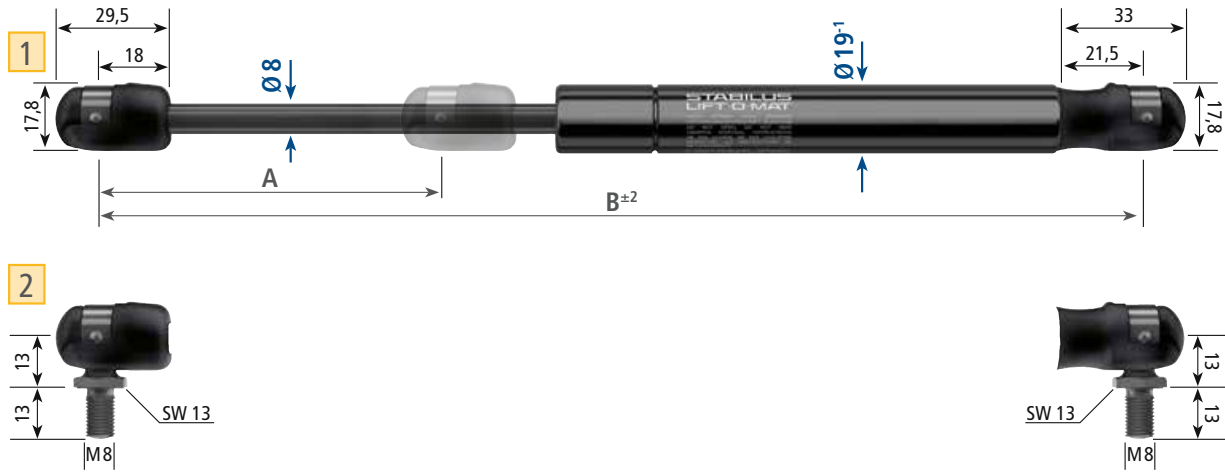

Suitable for ball studs according to DIN 71803 Ø10
 Passend für Kugelzapfen nach DIN 71803 Ø10



A		B			
Stroke Hub	Extended length Ausgesch. Länge	Force / Kraft F _i [N]	1 Ref.-No. Bestell-Nr.	2 Ref.-No. Bestell-Nr.	
60	205	500	2616NQ	094471	
		600	2617NL	083240	
		700	2618NG	083259	
		800	2619NB	094412	
80	245	100	752614	447609	
		150	752622	466441	
		200	1417EP	381926	
		250	752630	287806	
		300	1418EK	368237	
		350	1419EF	550817	
		400	752649	278076	
		500	752657	083305	
		600	752665	083313	
		700	2622ND	083321	
		800	2623NZ	094420	
		100	285	100	752673
150	752681			09275H	
200	1421EM			315826	
250	752703			150344	
300	1422EH			632600	
350	1423EC			462047	
400	752711			709492	
500	752738			083380	
600	752746			083399	
700	2624NU			083402	
800	2625NP			094439	

A		B			
Stroke Hub	Extended length Ausgesch. Länge	Force / Kraft F _i [N]	1 Ref.-No. Bestell-Nr.	2 Ref.-No. Bestell-Nr.	
120	325	100	752754	253308	
		150	752762	265802	
		200	1424EY	3008AM	
		250	752770	244880	
		300	1425ET	377007	
		350	1426EO	510599	
140	365	400	752789	684872	
		500	752797	094498	
		600	752800	083461	
		700	2626NK	083488	
		800	2627NF	094447	
		100	711506	177032	
		150	711745	287814	
		200	031970	630896	
		250	033973	253723	
		300	2819WF	3579UR	
		350	711984	152495	
		400	2628NA	083534	
500	2629NW	083542			
600	2631NC	083550			
700	2632NY	083569			
800	2633NT	094455			

We reserve the right to make modifications. Dimensions in mm.
 Änderungen vorbehalten. Maßangaben in mm.



A		B			
Stroke Hub	Extended length Ausgesch. Länge	Force / Kraft F_1 [N]	1 Ref.-No. Bestell-Nr.	2 Ref.-No. Bestell-Nr.	
160	405	100	752819	083577	
		150	752827	095621	
		200	1427EJ	083585	
		250	752835	095648	
		300	1428EE	083593	
		350	1431EG	095656	
		400	752843	083607	
		500	752851	083615	
		600	752878	083623	
		800	2634NO	083631	
180	445	100	2635NJ	094463	
		100	2636NE	083658	
		150	2638NV	094501	
		200	2639NQ	083666	
		250	2641NX	094528	
		300	2642NS	083674	
		350	2643NN	094536	
		400	2644NI	083682	
		500	2645ND	083690	
		600	2646NZ	083704	
200	485	700	2647NU	083712	
		800	2648NP	094544	
		100	752886	083720	
		150	752894	094552	
		200	1432EB	083739	
		250	752908	094560	

A		B			
Stroke Hub	Extended length Ausgesch. Länge	Force / Kraft F_1 [N]	1 Ref.-No. Bestell-Nr.	2 Ref.-No. Bestell-Nr.	
200	485	300	1433EX	083747	
		350	1434ES	094579	
		400	752916	083755	
		500	752924	083763	
		600	752932	083771	
		700	2649NK	083798	
		800	2651NR	094587	
		220	525	100	
150	2653NH			094595	
200	2654NC			083828	
250	2655NY			094609	
300	2656NT			083836	
350	2657NO			094617	
400	2658NJ			083844	
500	2659NE			083852	
600	2661NL	083860			
700	2662NG	083879			
800	2663NB	094625			
250	585	100	752940	083887	
		150	752959	094633	
		200	1435EN	083895	
		250	752967	094641	
		300	1436EI	083909	
		350	1437ED	094668	
		400	752975	083917	
		500	752983	083925	
		600	752991	083933	
		700	2664NX	083941	
800	2665NS	094676			



We reserve the right to make modifications. Dimensions in mm.
Änderungen vorbehalten. Maßangaben in mm.

LIFT-O-MAT®

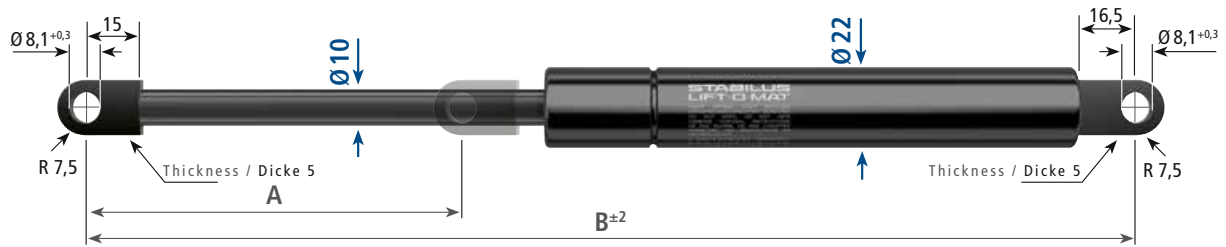

A	B		
Stroke Hub	Extended length Ausgesch. Länge	Force / Kraft F ₁ [N]	Ref.-No. Bestell-Nr.
96	285	900	084832
		1000	084840
		1150	094986
145	385	900	084875
		1000	084883
		1150	094994
196	485	900	084913
		1000	084921
		1150	095001
246	585	900	084964
		1000	084972
		1150	095028
296	685	150	095036
		200	095044
		250	095052
		300	095060
		350	095079
		400	095087
		500	095095
		600	095109
		700	084980
		800	084999
		900	085014
1000	085022		
1150	097306		

A	B		
Stroke Hub	Extended length Ausgesch. Länge	Force / Kraft F ₁ [N]	Ref.-No. Bestell-Nr.
346	785	150	095117
		200	095125
		250	095133
		300	095141
		350	095176
		400	095168
		500	095184
		600	095192
		700	085030
		800	085049
396	885	900	085057
		1000	085065
		150	095214
		200	095222
		250	095230
		300	095249
		350	095257
		400	095265
		500	095273
		600	095281
700	085073		
800	086401		

We reserve the right to make modifications. Dimensions in mm.
Änderungen vorbehalten. Maßangaben in mm.

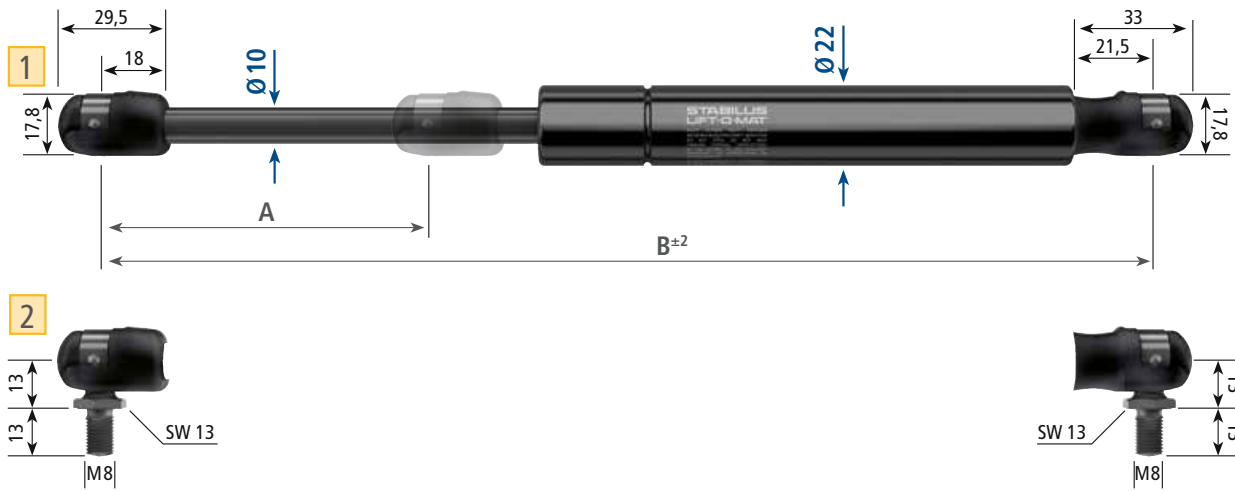

Suitable for ball studs according to DIN 71803 Ø10
 Passend für Kugelzapfen nach DIN 71803 Ø10

A		B			
Stroke Hub	Extended length Ausgesch. Länge	Force / Kraft F _i [N]	1 Ref.-No. Bestell-Nr.	2 Ref.-No. Bestell-Nr.	
100	285	900	2666NN	085146	
		1000	2667NI	085154	
		1150	2668ND	095303	
150	385	900	2669NZ	085189	
		1000	2671NF	085197	
		1150	2672NA	095311	
200	485	700	1442EW	497614	
		800	1443ER	232785	
		900	1444EM	085227	
		1000	1445EH	085235	
		1150	2673NW	095338	
250	585	700	1446EC	292001	
		800	1447EY	303925	
		900	1448ET	085278	
		1000	1449EO	085286	
		1150	2674NR	095346	
300	685	150	2675NM	095354	
		200	3935LP	095362	
		250	1438EZ	095370	
		300	2677NC	095389	
		350	1652CK	095397	
		400	753009	095400	
		500	2679NT	095419	
		600	2682NV	095427	
		700	753017	085294	
		800	2683NQ	085308	
		900	753025	085316	
		1000	753033	085324	
		1150	2684NL	095435	

A		B			
Stroke Hub	Extended length Ausgesch. Länge	Force / Kraft F _i [N]	1 Ref.-No. Bestell-Nr.	2 Ref.-No. Bestell-Nr.	
350	785	150	2685NG	095443	
		200	2686NB	095451	
		250	1439EU	095478	
		300	2687NX	095486	
		350	2688NS	095494	
		400	753041	095508	
		500	2689NN	095516	
		600	2691NU	095524	
		700	753068	085332	
		800	2692NP	085340	
400	885	900	753076	085359	
		1000	753084	085367	
		150	2694NF	095540	
		200	2695NA	095559	
		250	1441EA	095567	
		300	2696NW	095575	
		350	2697NR	095583	
		400	753092	095591	
		500	2698NM	095605	
		600	2699NH	095613	
700	753106	085375			
800	2701NN	085383			

LIFT-O-MAT®

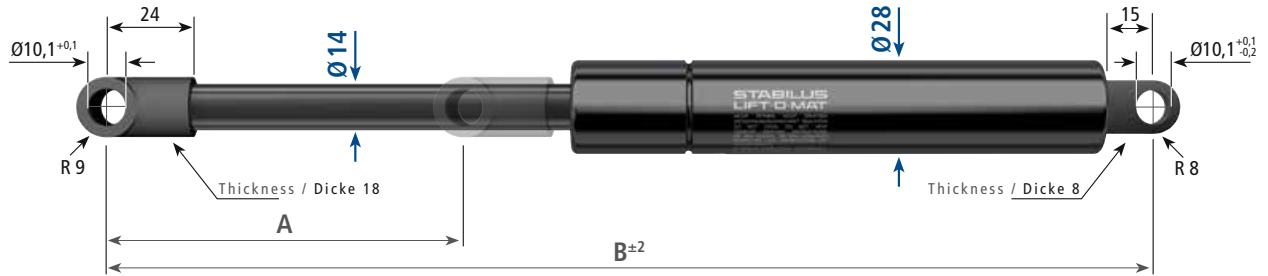

A	B		
Stroke Hub	Extended length Ausgesch. Länge	Force / Kraft F ₁ [N]	Ref.-No. Bestell-Nr.
100	302	1300	1847LW
		1500	2038LR
		1700	2039LM
		1900	2041LT
		2100	2042LO
150	402	1300	1851LT
		1500	2043LJ
		1700	2044LE
		1900	2046LV
		2100	2047LQ
200	502	1300	1854LE
		1500	2048LL
		1700	2049LG
		1900	2051LN
		2100	2052LI
250	602	1300	1858LL
		1500	2055LU
		1700	2056LP
		1900	2057LK
		2100	2058LF
300	702	1300	1862LI
		1500	2059LA
		1700	2061LH
		1900	2062LC
		2100	2063LY

A	B		
Stroke Hub	Extended length Ausgesch. Länge	Force / Kraft F ₁ [N]	Ref.-No. Bestell-Nr.
350	802	1300	1865LU
		1500	2064LT
		1700	2065LO
		1900	2066LJ
		2100	2067LE
400	902	1300	1868LF
		1500	2069LV
		1700	2071LB
		1900	2072LX
		2100	2073LS
500	1102	500	1872LC
		600	2108LB
		700	2109LX
		800	2111LD
		900	2112LZ
		1000	2113LU
		1100	2114LP
		1300	2115LK
		1500	2116LF
1700	2117LA		
1900	2118LW		

We reserve the right to make modifications. Dimensions in mm.
Änderungen vorbehalten. Maßangaben in mm.

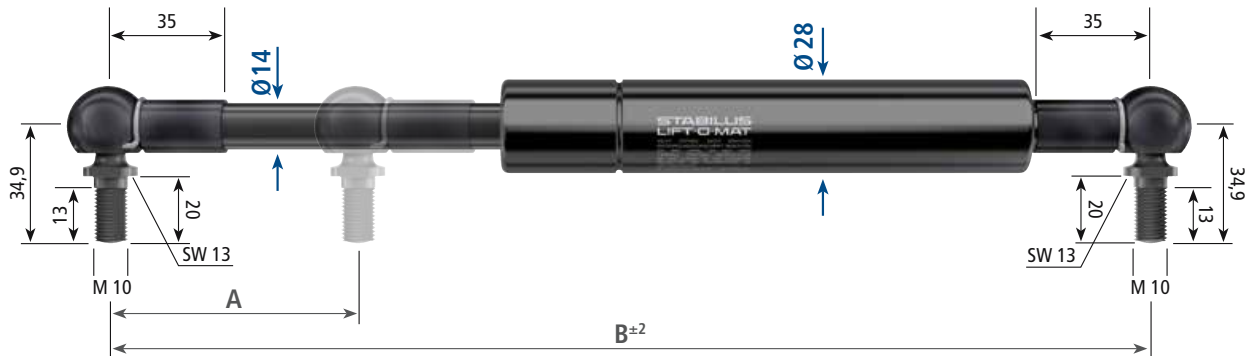

Suitable for ball studs according to DIN 71803 Ø16
 Passend für Kugelzapfen nach DIN 71803 Ø16

A	B		
Stroke Hub	Extended length Ausgesch. Länge	Force / Kraft F ₁ [N]	Ref.-No. Bestell-Nr.
100	335,5	1300	2029LS
		1500	2357LQ
		1700	2358LL
		1900	2359LG
		2100	2361LN
150	435,5	1300	2033LP
		1500	2362LI
		1700	2363LD
		1900	2364LZ
		2100	2365LU
200	535,5	1300	2036LA
		1500	2366LP
		1700	2367LK
		1900	2368LF
		2100	2369LA
250	635,5	1300	2075LI
		1500	2371LH
		1700	2372LC
		1900	2373LY
		2100	2374LT
300	735,5	1300	2078LU
		1500	2375LO
		1700	2376LJ
		1900	2377LE
		2100	2379LV

A	B		
Stroke Hub	Extended length Ausgesch. Länge	Force / Kraft F ₁ [N]	Ref.-No. Bestell-Nr.
350	835,5	1300	2082LR
		1500	2381LB
		1700	2382LX
		1900	2383LS
		2100	2384LN
400	935,5	1300	2085LC
		1500	2385LI
		1700	2386LD
		1900	2387LZ
		2100	2388LU
500	1135,5	500	2088LO
		600	2389LP
		700	2391LW
		800	2392LR
		900	2393LM
		1000	2394LH
		1100	2395LC
		1300	2396LY
1500	2397LT		
1700	2398LO		



We reserve the right to make modifications. Dimensions in mm.
 Änderungen vorbehalten. Maßangaben in mm.

LIFT-O-MAT®

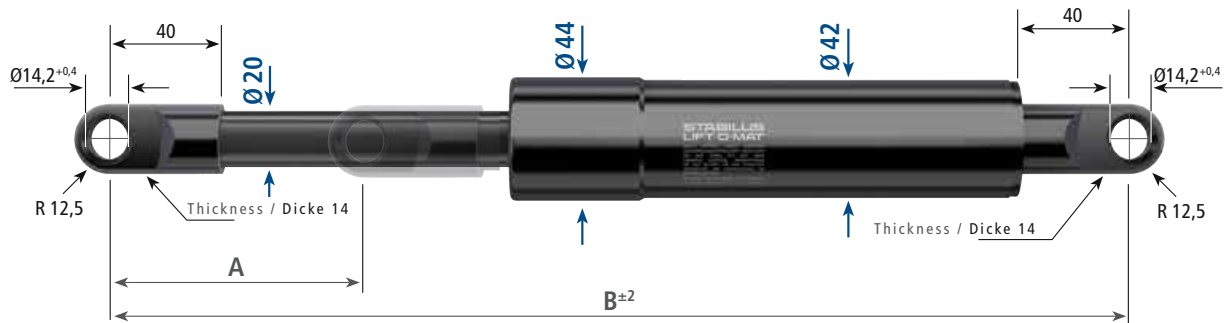

A		B	
Stroke Hub	Extended length Ausgesch. Länge	Force / Kraft F ₁ [N]	Ref.-No. Bestell-Nr.
150	500	2400	095974
		2800	095982
		3200	207519
		3600	207527
		4000	155624
		4600	207535
200	600	5200	207543
		2400	086657
		2800	086665
		3200	207462
		3600	207470
		4000	207489
250	700	4600	207497
		5200	207500
		2400	086738
		2800	086746
		3200	207551
		3600	207578
300	800	4000	207586
		4600	207594
		5200	207608
		2400	086789
		2800	086800
		3200	207616
		3600	207624
		4000	207632
		4600	207640
		5200	207659

A		B	
Stroke Hub	Extended length Ausgesch. Länge	Force / Kraft F ₁ [N]	Ref.-No. Bestell-Nr.
350	900	2400	096083
		2800	096091
		3200	207667
		3600	207675
		4000	207683
		4600	207691
400	1000	5200	207705
		2400	086924
		2800	086932
		3200	207713
		3600	207721
		4000	207748
500	1200	4600	207756
		5200	207764
		2400	086983
		2800	086991
		3200	207772
		3600	207780
		4000	207799
		4600	207802
		5200	207810

We reserve the right to make modifications. Dimensions in mm.
Änderungen vorbehalten. Maßangaben in mm.

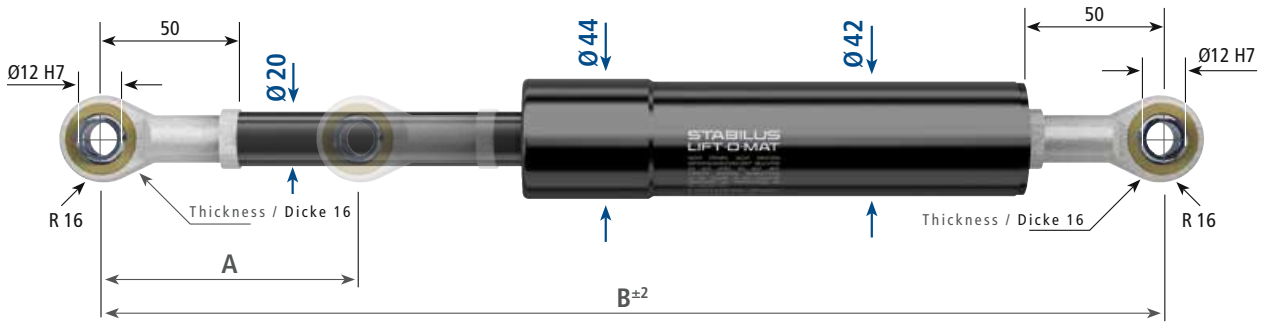

A	B		
Stroke Hub	Extended length Ausgesch. Länge	Force / Kraft F _i [N]	Ref.-No. Bestell-Nr.
150	520	2400	087041
		2800	087068
		3200	207829
		3600	207837
		4000	207845
		4600	207853
200	620	5200	207861
		2400	087114
		2800	087122
		3200	207888
		3600	207896
		4000	207918
250	720	4600	207926
		5200	207934
		2400	087173
		2800	087181
		3200	207942
		3600	207950
300	820	4000	207969
		4600	207977
		5200	207985
		2400	087254
		2800	087262
		3200	207993
		3600	208000
		4000	208019
		4600	208027
		5200	208035

A	B		
Stroke Hub	Extended length Ausgesch. Länge	Force / Kraft F _i [N]	Ref.-No. Bestell-Nr.
350	920	2400	087319
		2800	087327
		3200	208043
		3600	208051
		4000	208078
		4600	208086
400	1020	5200	208094
		2400	087386
		2800	087394
		3200	208108
		3600	208116
		4000	208124
500	1220	4600	208132
		5200	208140
		2400	087440
		2800	087459
		3200	208159
		3600	208167
		4000	208175
		4600	208183
		5200	208191



We reserve the right to make modifications. Dimensions in mm. Änderungen vorbehalten. Maßangaben in mm.

LIFT-O-MAT® DD



Dynamic extension damping

The LIFT-O-MAT DD with dynamic damping is a gas spring whose damping properties and extension speed is controlled primarily through a longitudinal groove in the pressure cylinder.

By reducing or increasing the groove cross-section, the piston rod's speed can be varied over the entire stroke, allowing it to be customized to the application. The motion can be slowed down smoothly and continuously until it comes to a stop.

It allows implementing different compression and extension characteristics as well as a damped approach of intermediate positions.

The LIFT-O-MAT DD works regardless of its orientation, while approaching any position smoothly, without stressing hinges and joints.

Advantages

- Orientation-independent damping
- Definable speed control
- Great tunability of damping characteristics

Dynamisch ausschubgedämpft

Der LIFT-O-MAT DD mit dynamischer Dämpfung ist eine Gasfeder, deren Dämpfungseigenschaften und die Steuerung der Ausschubgeschwindigkeit im Wesentlichen durch eine Längsnut im Druckrohr definiert werden. Durch entsprechende Erweiterung bzw. Verringerung des Nutquerschnittes lässt sich über den gesamten Hub die Bewegungsgeschwindigkeit der Kolbenstange beliebig festlegen und somit in idealer Weise an die jeweilige Anwendung anpassen. Der Bewegungsvorgang kann so harmonisch und kontinuierlich bis zum annähernden Stillstand verringert werden.

Eine unterschiedliche Ein- und Ausschubcharakteristik ist ebenso realisierbar wie gedämpftes

Anfahren von Zwischenpositionen.

Der LIFT-O-MAT DD funktioniert lageunabhängig und bewirkt ein komfortables, scharnier- bzw. gelenkschonendes Anfahren der gewünschten Position.

Vorteile

- Lageunabhängige Dämpfung
- Definierte Geschwindigkeitssteuerung
- Große Einflussmöglichkeit auf die Dämpfungscharakteristik

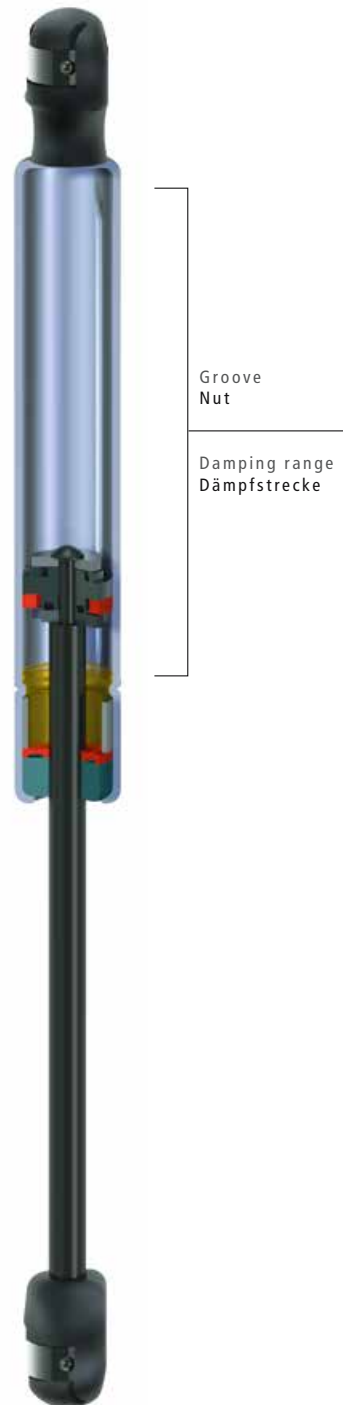

LIFT-O-MAT® DD

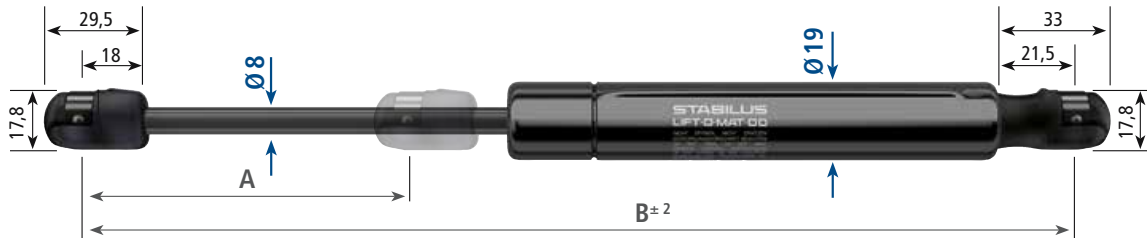

Suitable for ball studs according to DIN 71803 Ø10
 Passend für Kugelzapfen nach DIN 71803 Ø10

A		B	
Stroke Hub	Extended length Ausgesch. Länge	Force / Kraft F ₁ [N]	Ref.-No. Bestell-Nr.
100	285	100	989233
		150	992579
		200	992818
		250	993057
		300	993296
		350	993535
		400	994013
		500	994252
120	325	600	994491
		100	042794
		150	044467
		200	044706
		250	044945
		300	045184
		350	045423
		400	045662
140	365	500	045901
		600	046379
		100	048530
		150	068367
		200	068606
		250	069084
		300	069323
		350	069562
160	405	400	069801
		500	070040
		600	070279
		100	072191
		150	072908
		200	073864
		250	074103
		300	074342
		350	074581
		400	074820
		500	075059
		600	075298

A		B	
Stroke Hub	Extended length Ausgesch. Länge	Force / Kraft F ₁ [N]	Ref.-No. Bestell-Nr.
180	445	100	081273
		150	081512
		200	081751
		250	083424
		300	083663
		350	083902
		400	084141
		500	084380
200	485	600	084619
		100	085336
		150	094896
		200	095135
		250	095374
		300	095852
		350	096330
		400	096569
220	525	500	096808
		600	097286
		100	101588
		150	101827
		200	102066
		250	102305
		300	102544
		350	102783
250	585	400	103022
		500	103261
		600	103739
		100	105173
		150	105412
		200	105890
		250	106129
		300	106368
		350	106846
		400	107324
		500	107563
		600	108519



We reserve the right to make modifications. Dimensions in mm.
 Änderungen vorbehalten. Maßangaben in mm.

LIFT-O-MAT®

Stabilus supplementary line Ergänzungsprogramm von Stabilus

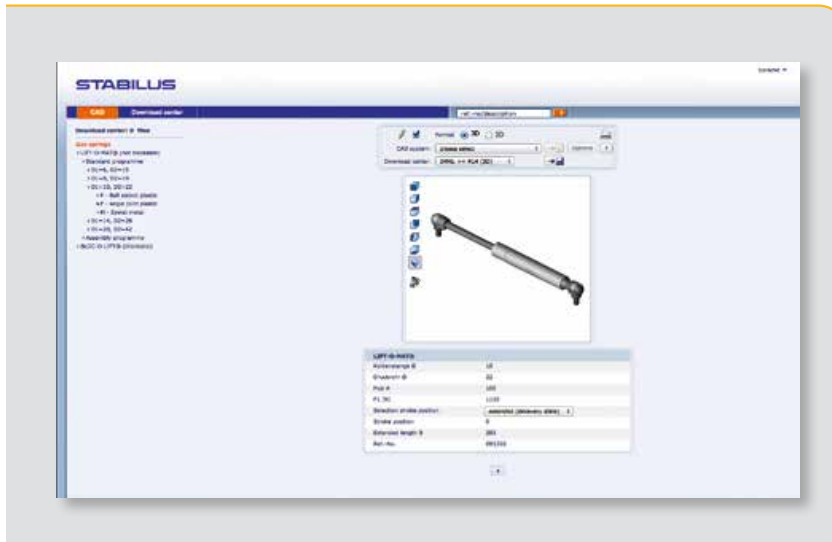

For each of our gas springs and dampers, there are numerous potential variants. Use them to configure the product variant that meets your requirements. Our options are almost endless.

Choose from different strokes, lengths, diameters and different fittings made from metal or plastic (K1 - K7 and D1 - D7). F₁ force can also be selected individually. Optional guard or locking tubes (S1 or S2) are also available.

You can use our online CAD-Configurator to render your 3D model and your 2D drawing.

CAD-Configurator
CAD-Konfigurator



Stabilus.cadclick.com

Für jede unserer Gasfedern und Dämpfer sind unzählige Varianten möglich. Konfigurieren Sie daraus eine Ihren Bedürfnissen entsprechende Produktvariante. Unseren Möglichkeiten sind fast keine Grenzen gesetzt.



Wählen Sie zwischen verschiedenen Hüben, Längen, Durchmessern und unterschiedlichen Anschlüssen aus Metall oder Kunststoff (K1 - K7 und D1 - D7). Auch die F₁-Kraft ist individuell wählbar. Optional haben Sie zudem die Möglichkeit ein Schutz- oder Arretierrohr (S1 oder S2) auszuwählen.

Nutzen Sie dazu auch unseren Online-CAD-Konfigurator zur Visualisierung Ihres ausgewählten 3D-Modells sowie Ihrer 2D-Zeichnung.

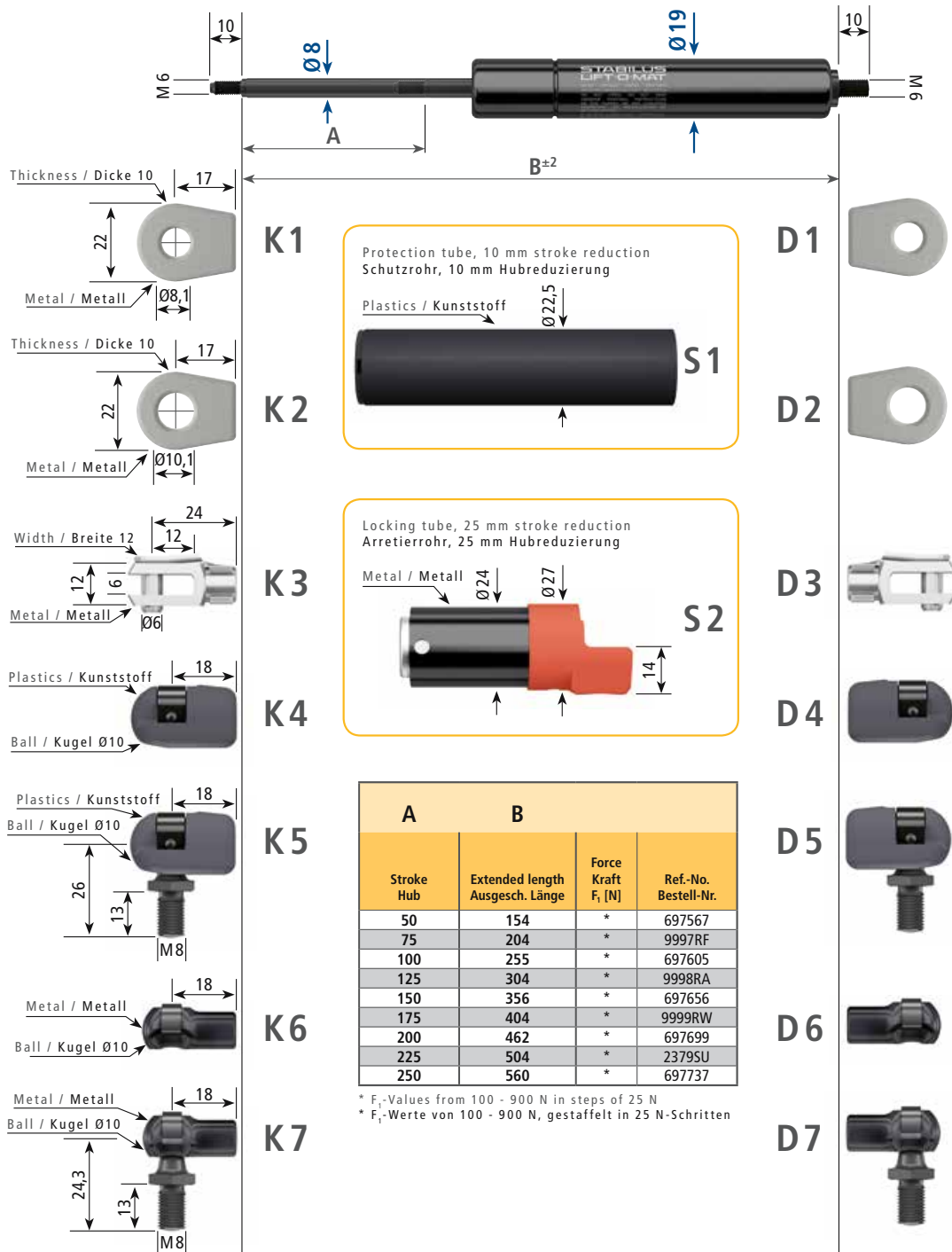

LIFT-O-MAT®

Ordering example / Bestell-Beispiel								
123456	/	0350N	/	K2	/	D1	/	S1
Ref.-No. Bestell-Nr.		F _i		Piston rod end fitting Kolbenstangen-Anschluss		Pressure tube end fitting Druckrohr-Anschluss		Optional tube Optionales Rohr

Installation according to STAB-Spec. 10005630 / Montage nach STAB-Spec. 10005630

We reserve the right to make modifications. Dimensions in mm.
Änderungen vorbehalten. Maßangaben in mm.

Protection tube, 10 mm stroke reduction
Schutzrohr, 10 mm Hubreduzierung

Plastics / Kunststoff $\varnothing 26$

Locking tube, 25 mm stroke reduction
Arretierrohr, 25 mm Hubreduzierung

Metal / Metall $\varnothing 24$ $\varnothing 27$ 14

A		B	
Stroke Hub	Extended length Ausgesch. Länge	Force Kraft F_1 [N]	Ref.-No. Bestell-Nr.
100	253,5	*	555762
125	304,5	*	2066UA
150	354,5	*	555800
175	405,5	*	2065UF
200	456,5	*	555843
225	504,5	*	2064UK
250	552,5	*	555894
275	603,5	*	2062UU
300	654,5	*	555932
325	705,5	*	2063UP
350	756,5	*	555975
375	804,5	*	2061UZ
400	852,5	*	556017

* F_1 -Values from 150 - 1000 N in steps of 50 N
* F_1 -Werte von 150 - 1000 N, gestaffelt in 50 N-Schritten

Ordering example / Bestell-Beispiel

123456	/	0350N	/	K2	/	D1	/	S1
Ref.-No. Bestell-Nr.		F_1		Piston rod end fitting Kolbenstangen-Anschluss		Pressure tube end fitting Druckrohr-Anschluss		Optional tube Optionales Rohr

Installation according to STAB-Spec. 10005625 / Montage nach STAB-Spec. 10005625

We reserve the right to make modifications. Dimensions in mm.
Änderungen vorbehalten. Maßangaben in mm.

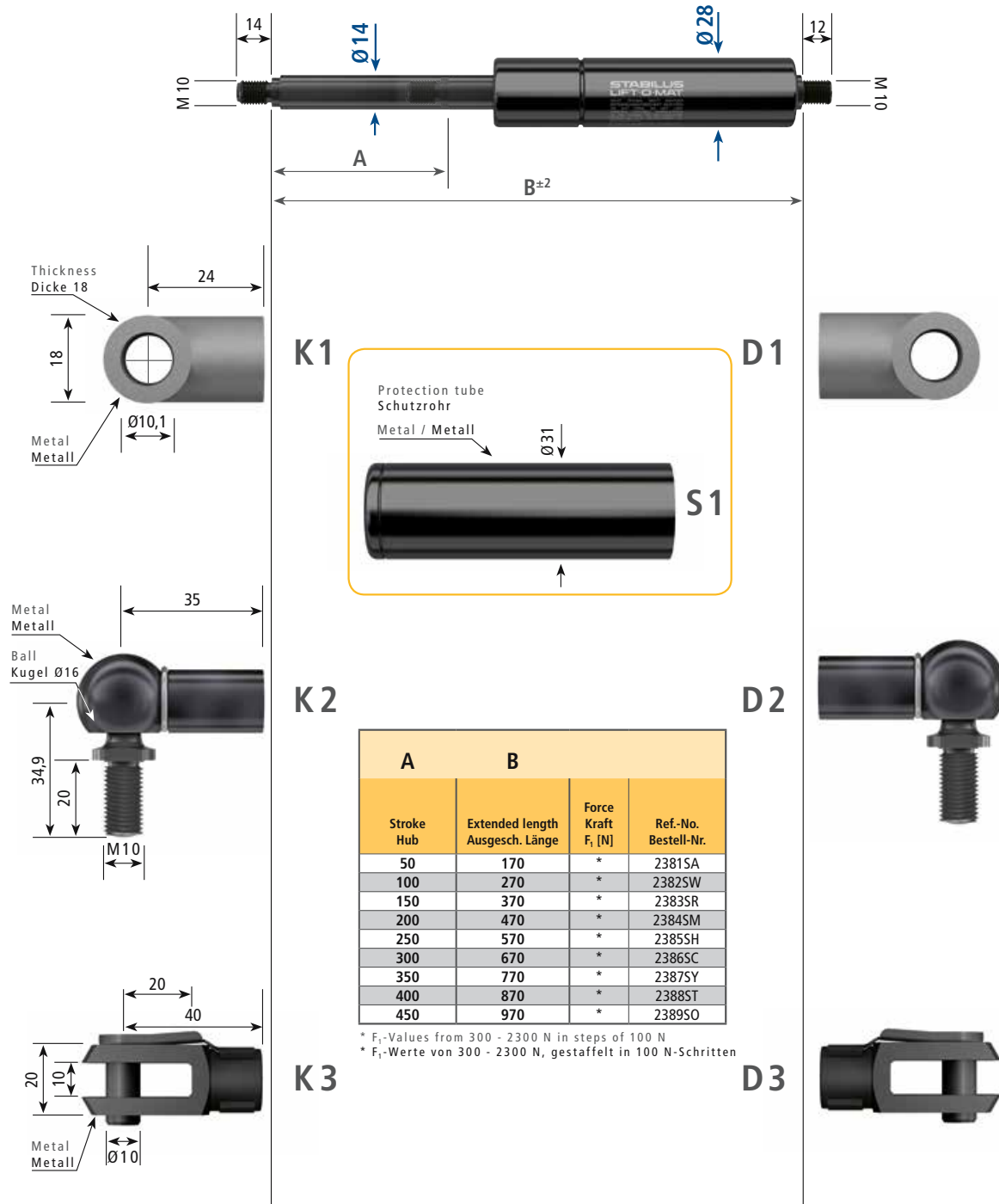

A		B	
Stroke Hub	Extended length Ausgesch. Länge	Force Kraft F_1 [N]	Ref.-No. Bestell-Nr.
50	170	*	2381SA
100	270	*	2382SW
150	370	*	2383SR
200	470	*	2384SM
250	570	*	2385SH
300	670	*	2386SC
350	770	*	2387SY
400	870	*	2388ST
450	970	*	2389SO

* F_1 -Values from 300 - 2300 N in steps of 100 N
 * F_1 -Werte von 300 - 2300 N, gestaffelt in 100 N-Schritten

Ordering example / Bestell-Beispiel

123456	/	0350N	/	K2	/	D1	/	S1
Ref.-No. Bestell-Nr.		F_1		Piston rod end fitting Kolbenstangen-Anschluss		Pressure tube end fitting Druckrohr-Anschluss		Optional tube Optionales Rohr

Installation according to STAB-Spec. 10021385 / Montage nach STAB-Spec. 10021385

We reserve the right to make modifications. Dimensions in mm. Änderungen vorbehalten. Maßangaben in mm.

LIFT-O-MAT® PTL



Self-locking in compressed position

The LIFT-O-MAT PTL from Stabilus is a hydraulically damped gas spring with an additional mechanical lock in the compressed position.

Similar to the ballpoint pen principle, the lock can be released by a light push on the gas spring; the gas spring will then automatically extend with damping.

In addition to the force assist function, the LIFT-O-MAT PTL features an end position lock, eliminating the need for installing additional locking elements. At the same time, it is easy and convenient to use.

This gas spring is used in numerous applications, especially in contemporary designer and functional furniture.

Advantages

- Locking in compressed position
- End position lock without additional locking elements
- Simple release of the lock using the ballpoint pen principle
- User-friendly, convenient operation
- Maintenance-free

Mit Selbstarretierung in eingeschobener Position

Der LIFT-O-MAT PTL von Stabilus ist eine hydraulisch gedämpfte Gasfeder, die zusätzlich in eingeschobener Lage mechanisch arretiert werden kann.

Ähnlich dem Kugelschreiberprinzip kann die Arretierung durch leichtes Zusammendrücken der Gasfeder gelöst werden, diese fährt dann selbständig und gedämpft wieder aus.

Neben der Kraftunterstützung verfügt der LIFT-O-MAT PTL über eine Endlagenarretierung, die den Verbau zusätzlicher Fixierelemente erspart. Gleichzeitig bietet er eine äußerst anwenderfreundliche, komfortable Bedienung.

Zum Einsatz kommt diese Gasfeder in zahlreichen Anwendungen, vor allem in modernen, innovativen Designer- und Funktionsmöbeln.

Vorteile

- Arretieren in eingeschobener Position
- Endlagenarretierung ohne zusätzliche Fixierelemente
- Einfaches Lösen der Arretierung durch Kugelschreiberprinzip
- Anwenderfreundliche, komfortable Bedienung
- Wartungsfrei

Locked in compressed position
Eingeschoben arretiert

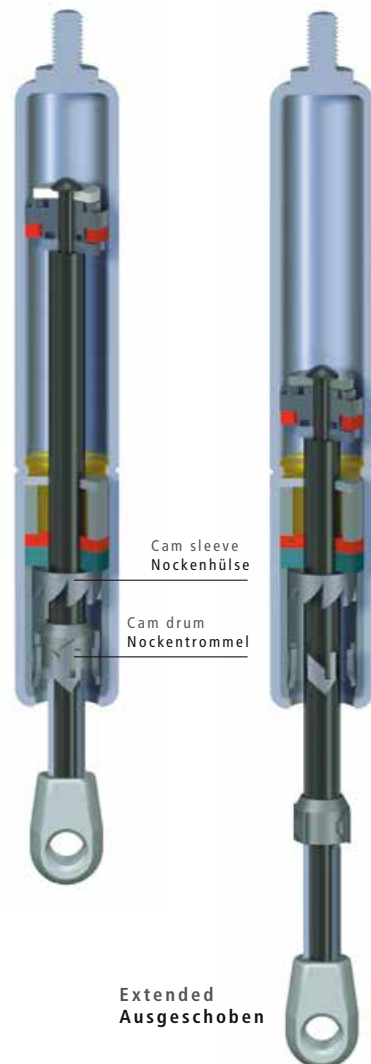

LIFT-O-MAT® PTL

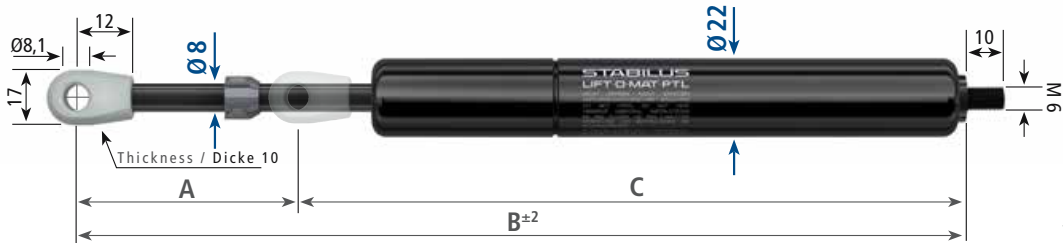

A	B	C		
Stroke Hub	Extended length Ausgesch. Länge	Lock position Lockposition	Force Kraft F ₁ [N]	Ref.-No. Bestell-Nr.
100	305	205	*	814763
150	405	255	*	815719
200	505	305	*	818587
250	605	355	*	819304
300	705	405	*	820021
350	805	455	*	820977
400	905	505	*	822411

* F₁-Values from 100 - 400 N in steps of 25 N
 * F₁-Werte von 100 - 400 N, gestaffelt in 25 N-Schritten

Temperature range -15°C to +60°C
 Temperatur Einsatzbereich -15°C bis +60°C

Ordering example / Bestell-Beispiel

123456	/	0350N	/	D1
Ref.-No. Bestell-Nr.		F ₁		Pressure tube end fitting Druckrohr-Anschluss

Installation according to STAB-Spec. 10203879 / Montage nach STAB-Spec. 10203879

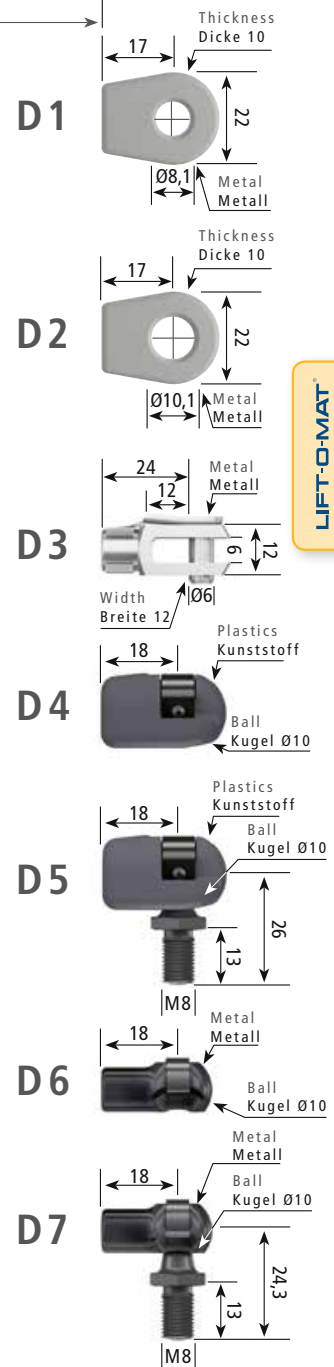

LIFT-O-MAT®

We reserve the right to make modifications. Dimensions in mm.
 Änderungen vorbehalten. Maßangaben in mm.

LIFT-O-MAT®

Brackets for gas springs and dampers Winkelbleche für Gasfedern und Dämpfer

Part No. / Bestell-Nr. **8262WE**
 $F_{max}^* = 1000\text{ N}$

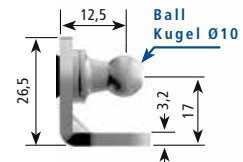
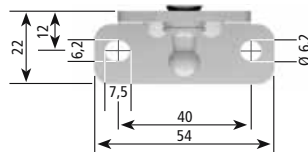

Part No. / Bestell-Nr. **8267WG**
 $F_{max}^* = 700\text{ N}$

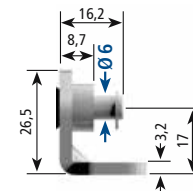
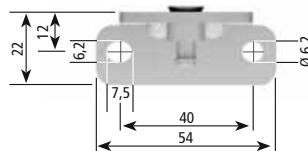

Part No. / Bestell-Nr. **8261WJ**
 $F_{max}^* = 1000\text{ N}$

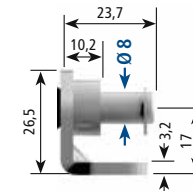
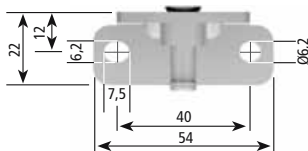

Part No. / Bestell-Nr. **8268WB**
 $F_{max}^* = 700\text{ N}$

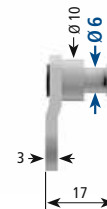
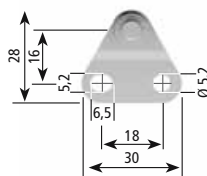

F_{max}^* = Maximum allowable force at 20°C in compressed position. Material: steel, zinc-plated.
 F_{max}^* = Maximale zulässige Belastung bei 20°C in eingeschobener Position. Material: Stahl, verzinkt.

Part No. / Bestell-Nr. 8264WV
 $F_{max}^* = 1000 \text{ N}$

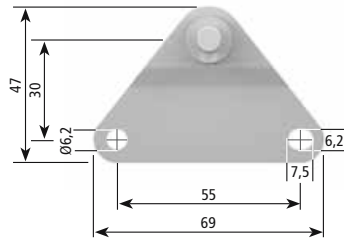

Part No. / Bestell-Nr. 8265WQ
 $F_{max}^* = 1000 \text{ N}$

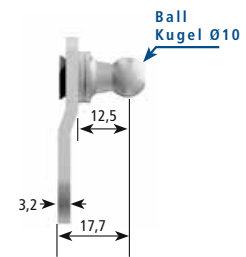
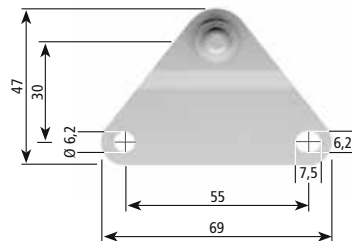

Part No. / Bestell-Nr. 023189
 $F_{max}^* = 700 \text{ N}$

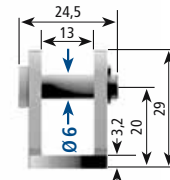
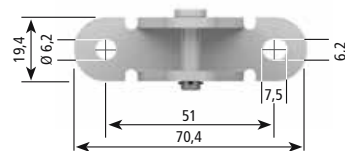

Part No. / Bestell-Nr. 023083
 $F_{max}^* = 1600 \text{ N}$

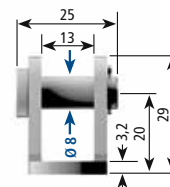
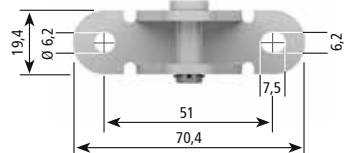

We reserve the right to make modifications. Dimensions in mm.
 Änderungen vorbehalten. Maßangaben in mm.

LIFT-O-MAT®

Brackets for gas springs and dampers Winkelbleche für Gasfedern und Dämpfer

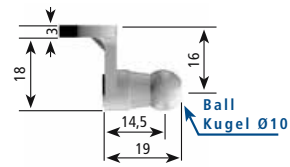
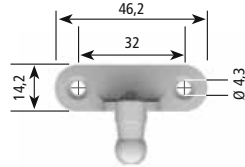
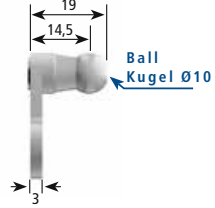
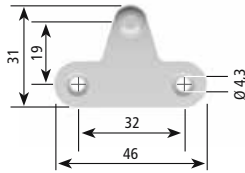
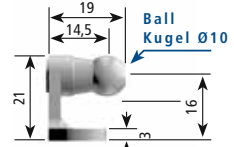
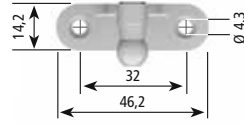

Ball stud / Kugelzapfen

4565BD
Clear passivated / Klar passiviert

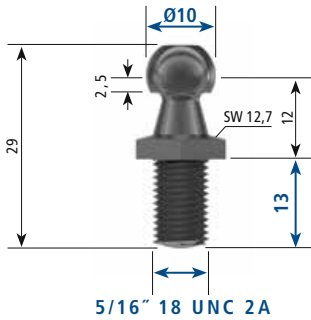

4486MD
Black passivated / Schwarz passiviert

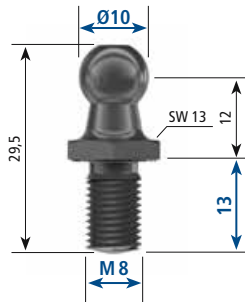

177583
Black passivated / Schwarz passiviert

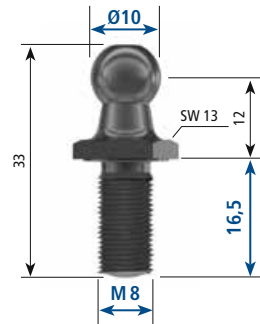

8442LT
Black passivated / Schwarz passiviert

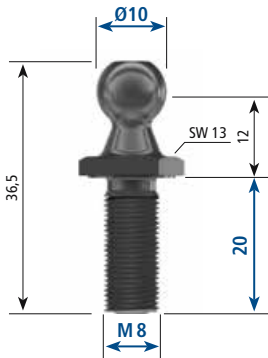

072796
Black passivated / Schwarz passiviert

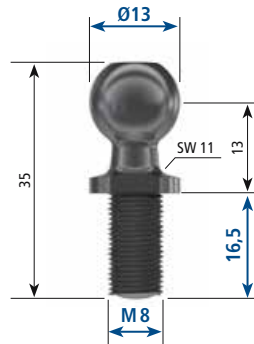

2054QF
Clear passivated / Klar passiviert

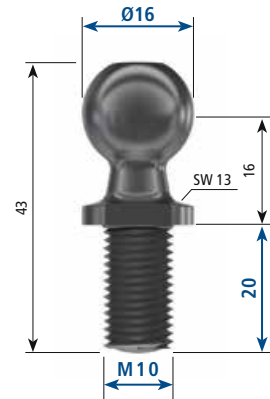

We reserve the right to make modifications. Dimensions in mm.
Änderungen vorbehalten. Maßangaben in mm.



Stainless steel gas springs for the most demanding applications

The LIFT-O-MAT INOXLINE is a gas spring that is particularly corrosion resistant due to the use of AISI 316L steel (see DIN EN 100 88-1). It is used in critical environments, such as corrosive sea water, sea air or industrial exhaust gases. Its corrosion resistance will ensure a high level of protection even during acid or lye exposure.

Carefully chosen materials for the LIFT-O-MAT INOXLINE components yield a virtually iron-free, non-magnetic product. This is especially attractive in medical and military technology as the stainless steel gas springs will barely interfere with the magnetic fields used in these indus-

tries. The oils used in the Stabilus INOXLINE gas springs are biodegradable and consequently eco-friendly; they are classified in the water hazard class "no hazard to water". This is especially important for the water supply and environmental technology areas.

Advantages

- High corrosion protection
- Non-magnetic
- Environmentally friendly fluids
- Compact design
- Maintenance-free

Edelstahl-Gasfedern für besonders anspruchsvolle Anwendungen

Der LIFT-O-MAT INOXLINE ist eine Gasfeder, die durch Verwendung von AISI 316L-Stahl besonders korrosionsbeständig ist (s. DIN EN 100 88-1). Er wird bei aggressiven Umweltbedingungen eingesetzt, z.B. bei korrosivem Seewasser, Seeluft oder Industrieabgasen. Wegen seines hohen Korrosionsschutzes gewährleistet er auch bei Säure- und Laugen-Belastung einen hohen Schutz. Durch die besondere Materialauswahl der verwendeten Bestandteile der LIFT-O-MAT INOXLINE resultiert ein weitestgehend eisenfreies und somit nicht magnetisches Produkt. Dies kommt vor allem der Medizin- und Militärtechnik zu Gute, da die dort verwendeten Magnetfelder kaum von den Edelstahl-Gasfedern beeinflusst werden.

Die als Hilfsstoffe verwendeten Öle in den Stabilus Gasfedern der INOXLINE sind biologisch abbaubar und damit umweltfreundlich, und werden in der Wassergefährdungsklasse (WGK) als „nicht Wasser gefährdend“ eingestuft. Dies ist insbesondere für den Wasserversorgungs- und Umwelttechnikbereich wichtig.

Vorteile

- Hoher Korrosionsschutz
- Nicht magnetisch
- Umweltfreundliche Füllungen
- Kompakte Bauweise
- Wartungsfrei



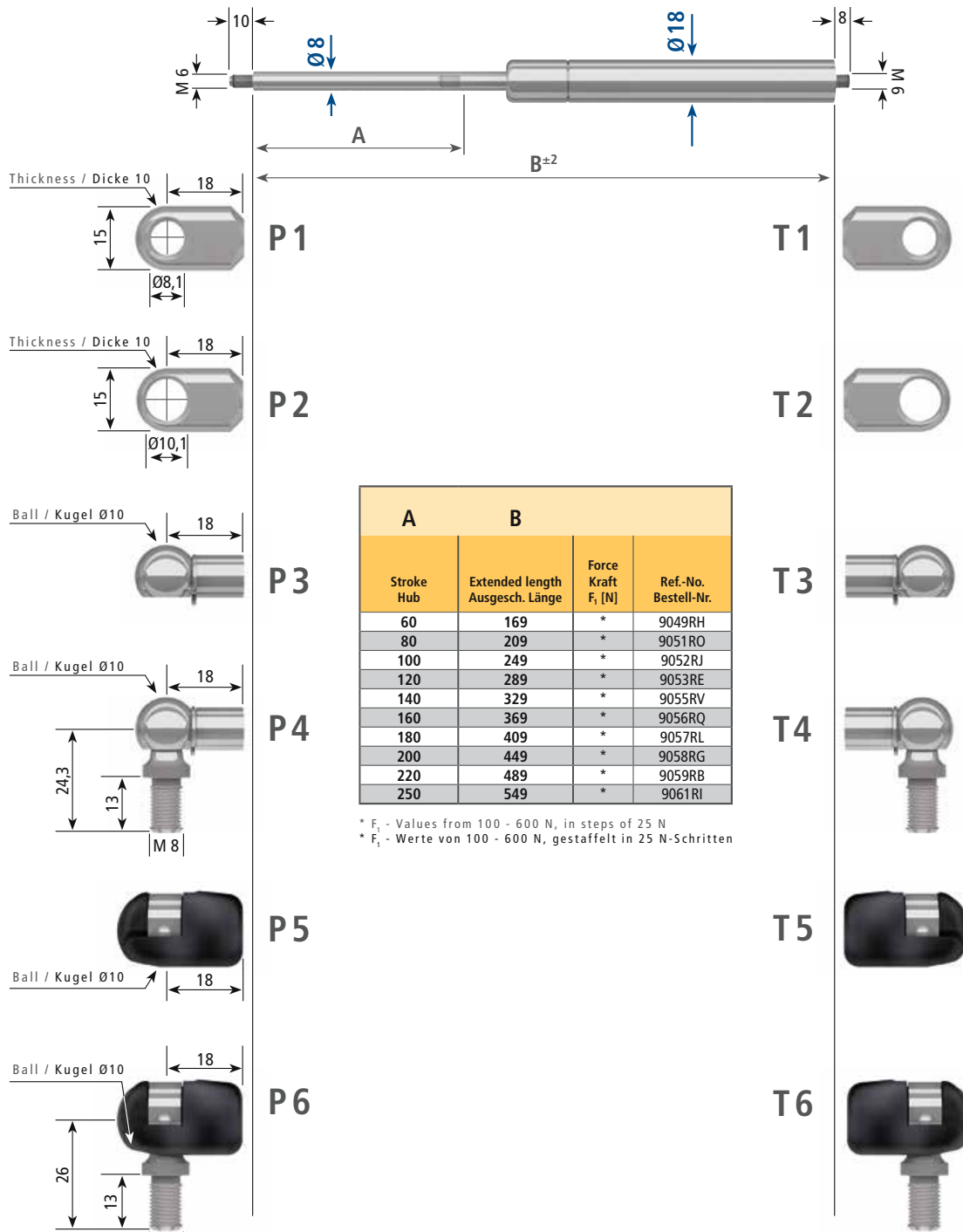

A		B	
Stroke Hub	Extended length Ausgesch. Länge	Force Kraft F ₁ [N]	Ref.-No. Bestell-Nr.
60	169	*	9049RH
80	209	*	9051RO
100	249	*	9052RJ
120	289	*	9053RE
140	329	*	9055RV
160	369	*	9056RQ
180	409	*	9057RL
200	449	*	9058RG
220	489	*	9059RB
250	549	*	9061RI

* F₁ - Values from 100 - 600 N, in steps of 25 N
 * F₁ - Werte von 100 - 600 N, gestaffelt in 25 N-Schritten

Ordering example / Bestell-Beispiel			
123456	/ 0350N	/ P2	/ T1
Ref.-No. Bestell-Nr.	F ₁	Piston rod end fitting Kolbenstangen-Anschluss	Pressure tube end fitting Druckrohr-Anschluss

Installation according to STAB-Spec. 10022248
 Montage nach STAB-Spec. 10022248

We reserve the right to make modifications. Dimensions in mm.
 Änderungen vorbehalten. Maßangaben in mm.

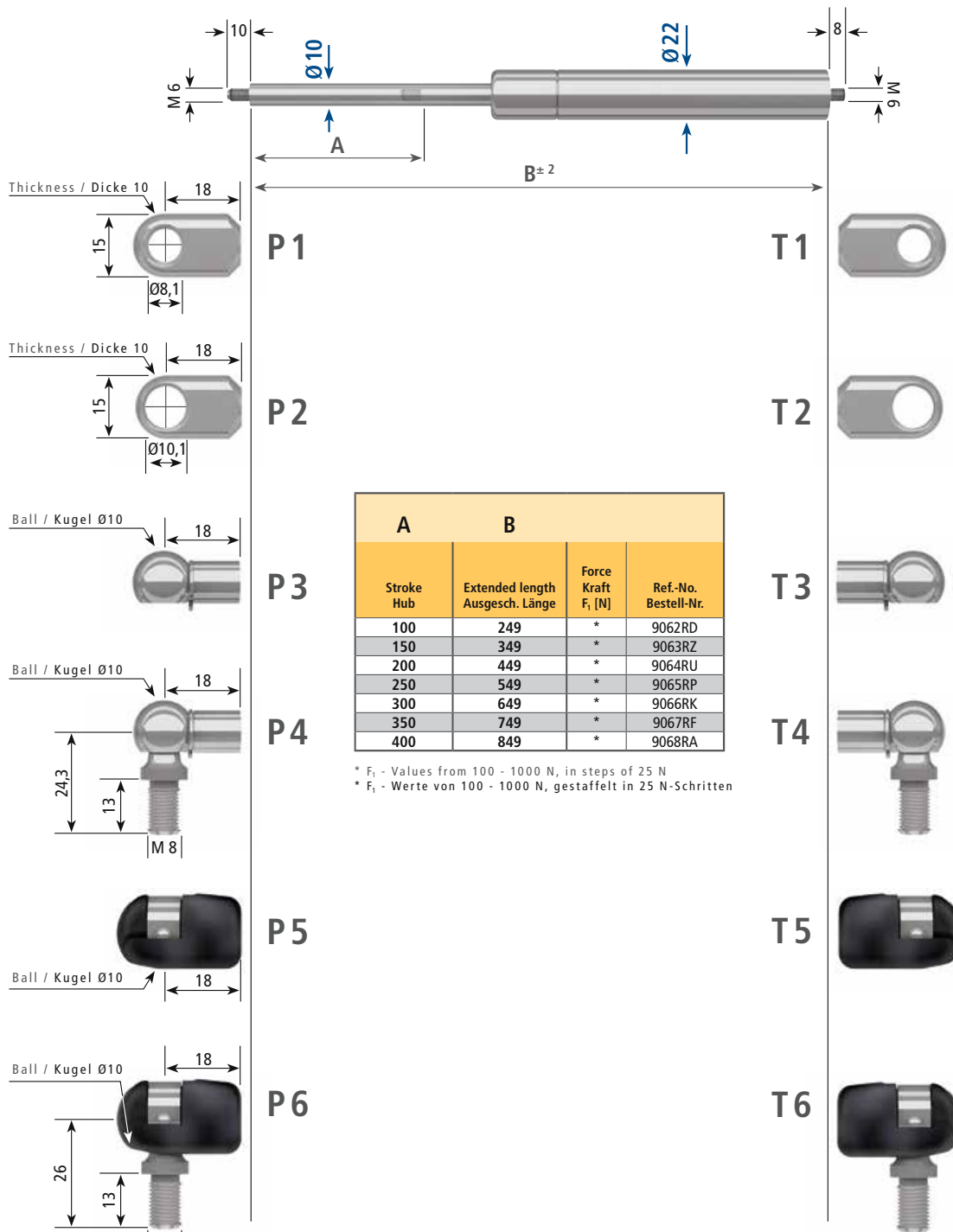

		A	B	
Stroke Hub	Extended length Ausgesch. Länge		Force Kraft F_1 [N]	Ref.-No. Bestell-Nr.
100	249		*	9062RD
150	349		*	9063RZ
200	449		*	9064RU
250	549		*	9065RP
300	649		*	9066RK
350	749		*	9067RF
400	849		*	9068RA

* F_1 - Values from 100 - 1000 N, in steps of 25 N
 * F_1 - Werte von 100 - 1000 N, gestaffelt in 25 N-Schritten

LIFT-O-MAT®

Ordering example / Bestell-Beispiel			
123456	/ 0350N	/ P2	/ T1
Ref.-No. Bestell-Nr.	F_1	Piston rod end fitting Kolbenstangen-Anschluss	Pressure tube end fitting Druckrohr-Anschluss

Installation according to STAB-Spec. 10022260
 Montage nach STAB-Spec. 10022260

We reserve the right to make modifications. Dimensions in mm.
 Änderungen vorbehalten. Maßangaben in mm.