

MIKROSCHALTER MICRO SWITCH



Baureihe
Series

PS1 PB1



Die Baureihe PS/PB zeichnet sich durch ein robustes Schaltwerk aus, das Stromgrößen von 0,2 A bis 15 A sicher schalten kann und eine hohe mechanische Lebensdauer aufweist. Die Schalter sind wahlweise als Wechsler, Schliesser oder Öffner anschliessbar. Bauform nach DIN 41635-E.

Typische Anwendungen:

- Fahrzeugbau
- Allgemeiner Maschinenbau
- Anlagen- und Apparatebau
- Medizintechnik

Series PS/PB is distinguished by a robust operating mechanism which can reliably switch currents of 0.2 A to 15 A and has a long mechanical lifetime. The micro switches can be connected in normally open, normally closed or changeover configurations. Type i.a.w. DIN 41635-E.

Typical applications:

- Automotive Equipment
- Industrial Mechanical Engineering
- Appliance and Industrial Engineering
- Medical Equipment

Abmessungen

Dimensions

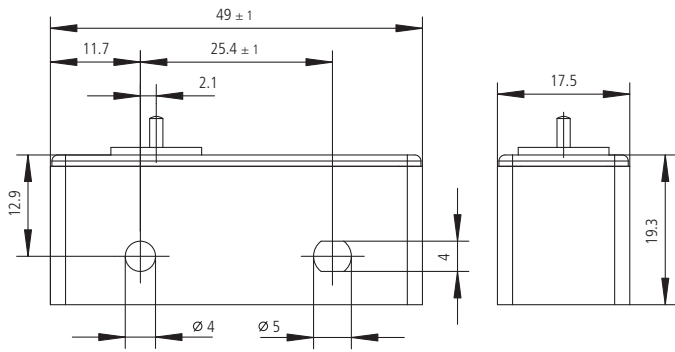

Schaltfunktion

Switching function

1 Wechsler
Change-over

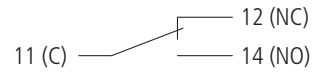

2 Schliesser
NO

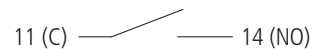

3 Öffner
NC



Betätiger (Auswahl)

Actuators

Rollen aus Kunststoff,
wahlweise auch in CuZn
oder Stahl lieferbar

Roller material Plastic
optional material Brass
or Steel

Legende | Overview

Sk Schaltklasse | Class

S Schaltkraft | Operating force

V Vorlaufweg | Pretravel

N Nachlaufweg | Overtravel

D Differenzweg | Movement differential

PS/PB1 01...

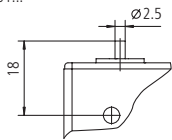

		PS		PB
Sk		2	3	3
S	N	2.5-4.5	3.5-6.5	4.0-8.0
V	mm	0.3-0.8		0.5-1.2
N	mm	>0.2		>0.2
D	mm	0.05-0.15		0.1-0.2

PS/PB1 02...

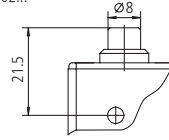

		PS		PB
Sk		2	3	3
S	N	2.5-4.5	3.5-6.5	4.0-8.0
V	mm	0.3-0.8		0.6-1.2
N	mm	>1.5		>0.8
D	mm	0.05-0.15		0.1-0.2

PS/PB1 03...

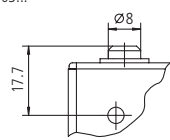

		PS		PB
Sk		2	3	3
S	N	2.5-4.5	3.5-6.5	4.0-8.0
V	mm	0.3-0.8		0.6-1.2
N	mm	>1.0		>0.8
D	mm	0.05-0.15		0.1-0.2

PS/PB1 04...

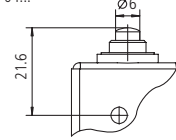

		PS		PB
Sk		2	3	3
S	N	2.5-4.5	3.5-6.5	4.0-8.0
V	mm	0.3-0.8		0.6-1.2
N	mm	>1.0		>1.5
D	mm	0.05-0.15		0.1-0.2

PS/PB1 06...

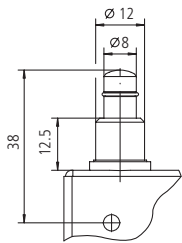

		PS		PB
Sk		2	3	3
S	N	2.5-4.5	3.5-6.5	4.0-8.0
V	mm	0.3-0.8		0.6-1.2
N	mm	>4.0		>4.5
D	mm	0.05-0.15		0.1-0.2

PS/PB1 08...

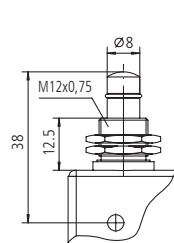

		PS		PB
Sk		2	3	3
S	N	2.5-4.5	3.5-6.5	4.0-8.0
V	mm	0.3-0.8		0.6-1.2
N	mm	>4.0		>4.5
D	mm	0.05-0.15		0.1-0.2

PS/PB1 09...

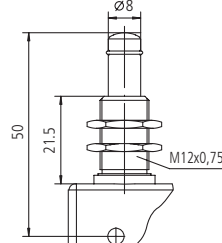

		PS		PB
Sk		2	3	3
S	N	2.5-4.5	3.5-6.5	4.0-8.0
V	mm	0.3-0.8		0.6-1.2
N	mm	>9.0		>9.0
D	mm	0.05-0.15		0.1-0.2

PS/PB1 10...

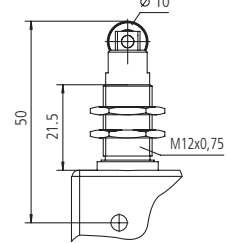

		PS		PB
Sk		2	3	3
S	N	2.5-4.5	3.5-6.5	4.0-8.0
V	mm	0.3-0.8		0.6-1.2
N	mm	>4.0		>4.0
D	mm	0.05-0.15		0.1-0.2

PS/PB1 11...

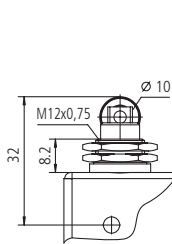

		PS		PB
Sk		2	3	3
S	N	2.5-4.5	3.5-6.5	4.0-8.0
V	mm	0.3-0.8		0.6-1.2
N	mm	>1.5		>1.5
D	mm	0.05-0.15		0.1-0.2

PS/PB1 12...

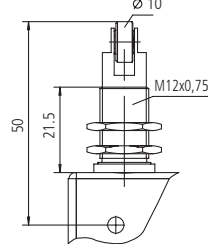

		PS		PB
Sk		2	3	3
S	N	2.5-4.5	3.5-6.5	4.0-8.0
V	mm	0.3-0.8		0.6-1.2
N	mm	>4.0		>4.0
D	mm	0.05-0.15		0.1-0.2

PS/PB1 13...

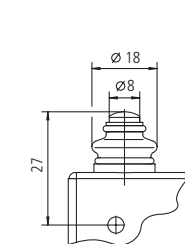

		PS		PB
Sk		3	3	3
S	N	3.5-6.5	4.0-8.0	4.0-8.0
V	mm	0.3-0.8		0.6-1.2
N	mm	>1.0		>0.8
D	mm	0.05-0.15		0.1-0.2

PS/PB1 14...

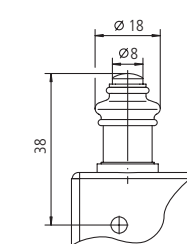

		PS		PB
Sk		3	3	3
S	N	3.5-6.5	4.0-8.0	4.0-8.0
V	mm	0.3-0.8		0.6-1.2
N	mm	>2.0		>2.0
D	mm	0.05-0.15		0.1-0.2

Betätiger (Auswahl) | Actuators

PS/PB1 15...

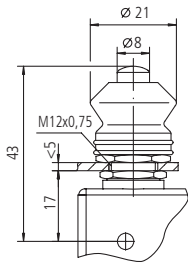

15		PS	PB
Sk	3		
S	N	3.5-6.5	4.0-8.0
V	mm	0.3-0.8	0.6-1.2
N	mm	>4.0	>4.0
D	mm	0.05-0.15	0.1-0.2

PS/PB1 18...

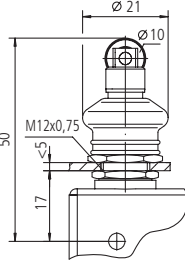

18		PS	PB
Sk	3		
S	N	3.5-6.5	4.0-8.0
V	mm	0.3-0.8	0.6-1.2
N	mm	>2.0	>2.0
D	mm	0.05-0.15	0.1-0.2

PS/PB1 19...

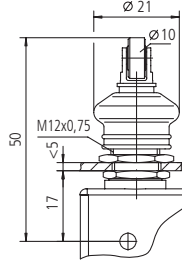

19		PS	PB
Sk	3		
S	N	3.5-6.5	4.0-8.0
V	mm	0.3-0.8	0.6-1.2
N	mm	>2.0	>2.0
D	mm	0.05-0.15	0.1-0.2

PS/PB1 30...

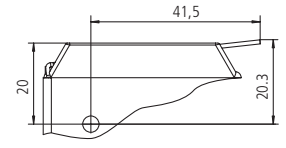

30		PS	PB
Sk	3		
S	N	0.3-1.0	0.3-0.6
V	mm	2.0-5.0	3.0-6.0
N	mm	>1.5	>2.5
D	mm	0.5-1.5	0.8-1.5

PS/PB1 31...

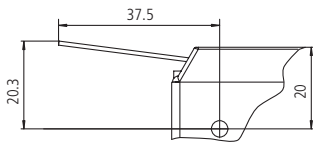

31		PS	PB
Sk	3		
S	N	0.3-1.0	0.3-0.6
V	mm	2.0-5.0	3.0-7.0
N	mm	>1.5	>2.5
D	mm	0.5-1.5	0.8-1.5

PS/PB1 35...

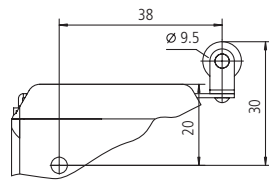

35		PS	PB
Sk	3		
S	N	0.2-0.5	0.3-0.6
V	mm	1.5-4.0	3.0-6.0
N	mm	>1.5	>2.5
D	mm	0.6-1.5	0.8-1.5

PS/PB1 36...

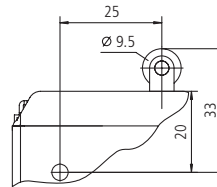

36		PS	PB
Sk	3		
S	N	0.6-1.4	0.4-0.8
V	mm	1.5-3.0	2.0-4.0
N	mm	>0.8	>1.0
D	mm	0.3-1.0	0.5-1.2

PS/PB1 40...

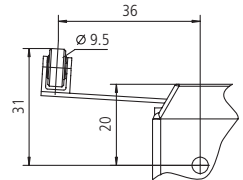

40		PS	PB
Sk	3		
S	N	0.3-1.0	0.3-1.0
V	mm	2.0-5.0	3.0-7.0
N	mm	>1.5	>2.0
D	mm	0.5-1.5	0.8-2.0

PS/PB1 60...

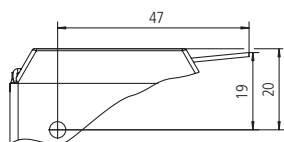

60		PS	PB
Sk	3		
S	N	0.5-1.5	0.4-0.7
V	mm	3.0-5.5	2.5-5.0
N	mm	>2.0	>2.5
D	mm	0.5-1.5	0.8-1.8

PS/PB1 65...

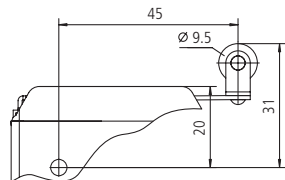

65		PS	PB
Sk	3		
S	N	0.5-1.5	0.4-0.7
V	mm	3.0-5.5	2.5-5.0
N	mm	>2.0	>2.5
D	mm	0.5-1.5	0.8-1.8

PS/PB1 91...

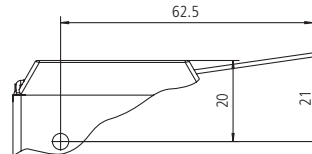

91		PS	PB
Sk	3		
S	N	0.3-1.0	0.7-1.3
V	mm	3.0-7.0	2.0-5.0
N	mm	>3.0	>3.0
D	mm	0.6-2.0	0.8-1.8

PS/PB1 94...

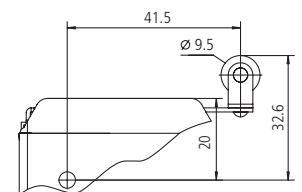

94		PS	PB
Sk	3		
S	N	0.7-1.3	0.9-1.4
V	mm	2.5-4.5	2.0-5.0
N	mm	>2.0	>2.0
D	mm	0.5-1.2	0.6-1.2

Zubehör | Accessories

Hauben, passend auf Schalter mit Anschluss | Cover, suitable for switches with connectors

PHDS
PS : 01, 02

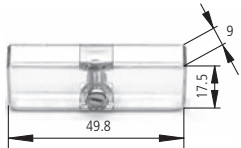

PHB
PS, PB : 01, 02

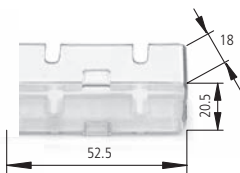

PHC
PS, PB : 01, 02, 03, 09

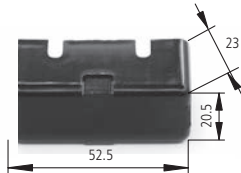

PH/PHM/PHN
PS, PB : 01, 02, 03

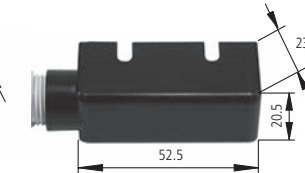

PHT/PHTM/PHTN
PS, PB : 01, 02, 03, 09

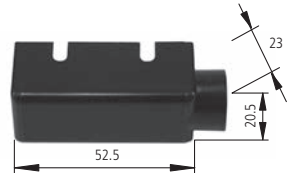

Kabeltülle | Seal ring
1005668

PH Gewinde PG 9 | Thread PG 9
PHM Druckschraube | Pressure Screw
PHN Dichtungsniessel | Sealing plug

PHT Gewinde PG 9 | Thread PG 9
PHTM Druckschraube | Pressure Screw
PHTN Dichtungsniessel | Sealing plug

Anschlüsse | Connection types

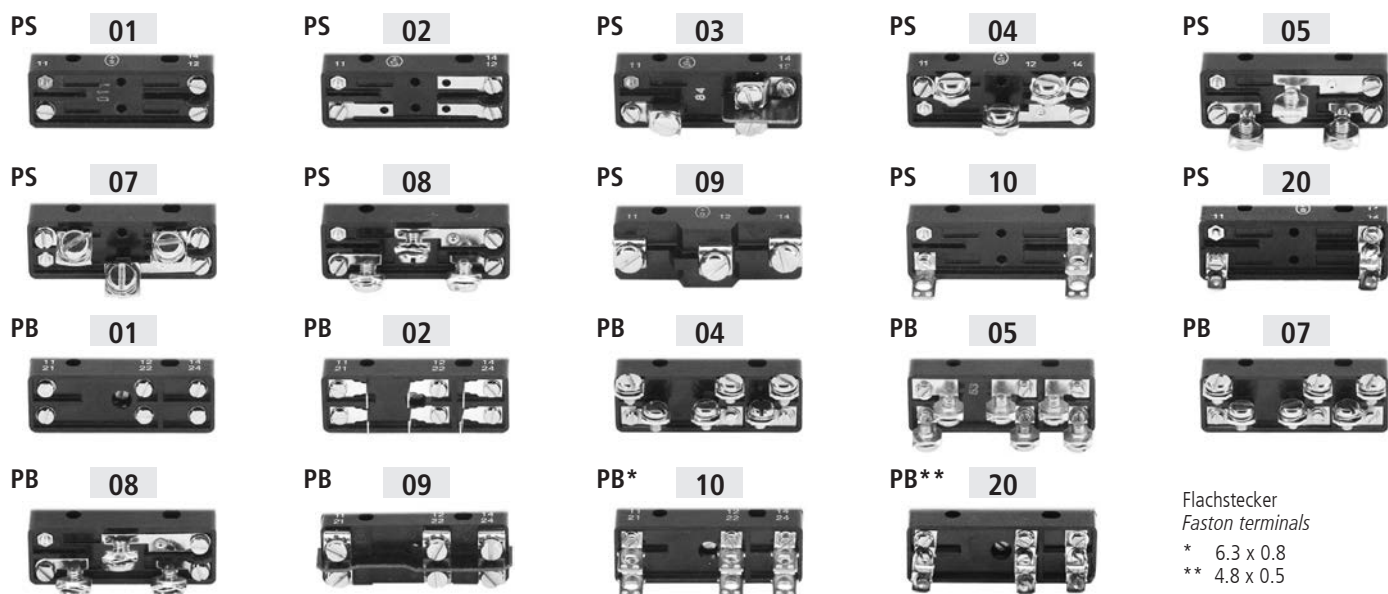

Flachstecker
Faston terminals
* 6.3 x 0.8
** 4.8 x 0.5

Bestellschlüssel | Ordering Key

P **1** . **06** **1** . **3** **10**

1 2 3 4 5

Beispiel | Example
PS1.061.310

1	Baureihe	Series
	S einpolig	S single pole
	B zweipolig	B dual pole
2	Betätiger	Actuator
3	Schaltfunktion	Switching function
4	Schaltklasse	Class
5	Anschlüsse	Connection types

Technische Daten | Technical Data

	Aufbau	Construction
Gehäusewerkstoff	Thermoplast GF	Housing material
Schutzart Innenraum	IP40 IEC 60529	Protection interior
Schutzart Anschluss	IP00 IEC 60529	Protection terminals

	Mechanische Daten (Wechsler)	Mechanical Data (Change-over)
Rückschaltkraft	> 1 N	Release force
Betätigungskraft max.	< 10 N	Max. operating force
Stromführende Teile	Cu-Legierung	Cu-alloy
Kontaktwerkstoff	Ag-Legierung	Ag-alloy
Mech. Lebensdauer	15 Mio. – 50 Mio.	Mechanical life
Schalzhäufigkeit	PS 300/min / PB 200/min	Frequency
Betätigungsgeschwindigkeit in Stößelrichtung	max. 0.5 m/sec	Operating speed in direction of plunger
Umgebungstemperatur	-10°C bis +85°C	14°F to +185°F
		Temperature range

	Elektrische Daten	Electrical Data
Nennspannung	250 VAC, 24 / 60 / 250 VDC	
Ohmsche Last	PS	PB
Dauerstrom	250 VAC, 15 A (25 A) 24 VDC, 6 A 60 VDC, 1.5 A 250 VDC, 0.2 A	250 VAC, 10 A 24 VDC, 6 A 60 VDC, 1.5 A 250 VDC, 0.2 A
Schaltleistung min.	12 VDC, 6 mA	
		Min. switching capacity

Hinweis Baureihe PB

Gleichzeitiges Kontaktöffnen ist nicht gewährleistet. Direkte Polwendung in der Regel nicht möglich, da die Selbstinduktion einer Spule zeitlich meist länger währt als die Schnappzeit des Schalters (Kurzschluss durch Öffnungsfunken).

Für kleinere Spannungen bzw. Ströme empfehlen wir Schalter mit vergoldeten Kontakten. Kundenspezifische Sonderlösungen auf Anfrage.

Note Series PB

It gives not garantie to open both contacts simultaneously. Direct polarity inverter isn't possible. The induction from coil in time is longer than the switch time (short circuit through break spark)

It is recommended to use gold-plated contacts for lower currents or voltages. Special types upon request.

