

RAVEN™ TRIM

©COPES VULCAN®

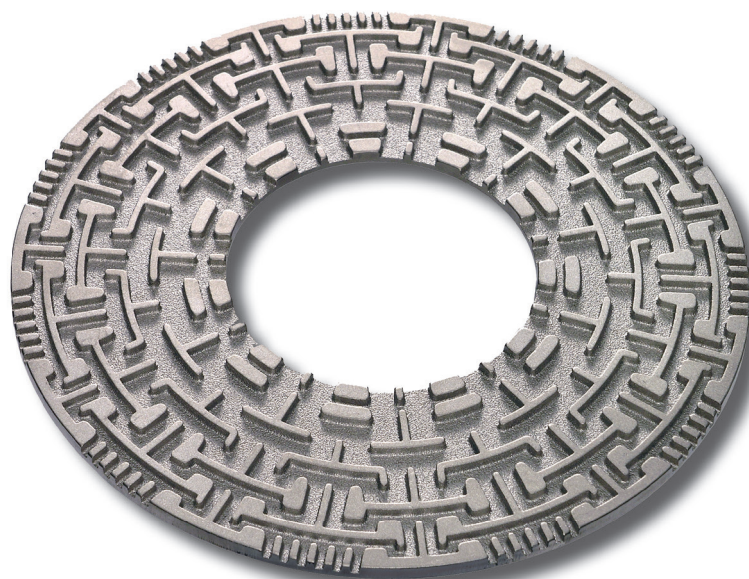

With its Copes-Vulcan brand, Celeros Flow Technology has been providing control valves and desuperheaters for the power, process and nuclear industries since 1903. Copes-Vulcan provides a wide range of valves for the control of pressure, temperature and flow-induced noise in all types of power plants. Products include severe service and general service control valves, variable orifice desuperheaters, Raven™, trim and steam-conditioning valves and nuclear control valves, as well as custom designed specialty valves. The Copes-Vulcan brand is recognized worldwide as a leader in valves for severe and critical service applications. Our strength lies in our ability to provide innovative valve solutions for our customers' application needs.



RAVEN™ TRIM

Celeros FT's Copes-Vulcan brand has been providing valves to the Power, Pulp & Paper, Oil & Gas, and Petrochemical industries since 1903, and is recognized worldwide as a leader in valves for severe and critical service applications. Our strength truly lies in our ability to provide innovative valve solutions for our customers' application problems. The RAVEN™ Control Valve incorporates a unique advanced design that is superb at rapidly reducing flow velocities, resulting in valves that provide quiet, non-cavitating and non-erosive service. Ultimately, each RAVEN™ trim is specifically designed to provide the finest severe duty valve service by:

**Reducing and
Attenuating
Velocity,
Erosion and
Noise**

The RAVEN™ Control Valve was developed by highly experienced engineers who took the well-proven labyrinth disc stack type of trim and introduced two main patented innovations: resistance to the effects of blockage and reduction in noise. The innovative designs give this well-established technology for severe service applications even more technical advantages over other currently available trim designs



RESISTANCE TO THE EFFECTS OF BLOCKAGE

The expanding passage design, combined with multiple entry points to the individual flow passages, make blockage very unlikely. Unlike conventional labyrinth trim designs, RAVEN™ has relief points built into the labyrinth design. Under normal operation, these relief points have virtually no flow through them. In the event of blockage, the relief points are utilized. Extensive testing has shown that if a blockage occurs in RAVEN™ trim, all inlet ports and outlet ports are still utilized, minimizing any reduction in Cv and ensuring that the minimum designed number of pressure reducing stages are still used. In conventional labyrinth stack designs, a blockage in the stack eliminates the Cv of that path completely and in the case of a partial blockage, can actually generate noise.



**TEST CASE SHOWING SEVERE BLOCKAGE.
ALL INLETS AND OUTLETS STILL IN USE.
NEGLECTIBLE LOSS IN CV.**

TYPICAL PRODUCT APPLICATIONS

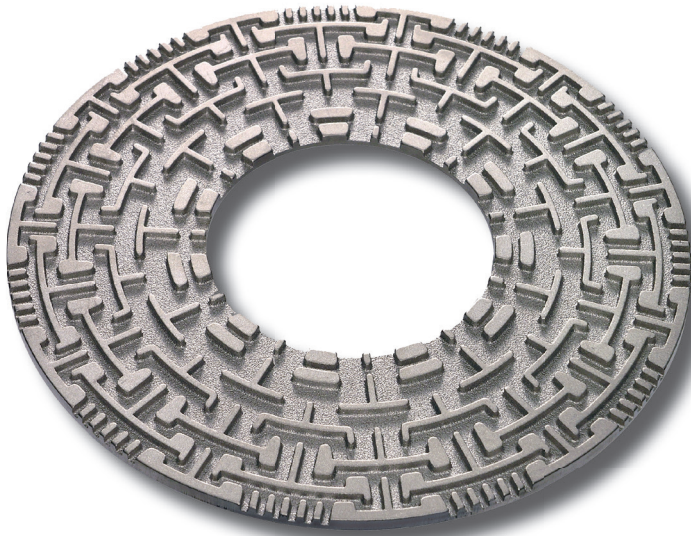

PROVEN SUPERIOR TECHNOLOGY

The actual gaseous flow through RAVEN™ trims shows the visible attachment phenomenon wherein the flow stream clings to each obstruction in its path, effectively taking the line of least resistance. Also, despite the multiple relief points in the flow path, it can clearly be seen that the fluid does not recombine within the RAVEN™ trim. The flow streams remain virtually separate from each other, ensuring the best velocity control.



Power/Auxiliary Power Units

- Boiler Feed Control
- Boiler Feed Pump Minimum Flow (Bypass)
- Inter Stage Attenuator Water Control
- Boiler Drum Level Control
- Soot Blower Header Control
- Turbine Bypass
- Start-Up Steam Vent
- Spray Water Control
- Deaerator Level Control
- Condenser Steam Dump
- Sampling Systems



Oil & Gas

- Feed Gas Regulator
- Overboard Water Dump Valves
- Water Injection Systems
- Pump Min Flow Valves
- Fire Water Pump Discharge Valves & Min Flow Valves
- Methanol Injection
- Vapor Recovery Systems
- Flue Gas Expander Bypass
- First Stage Separator Level Control



Gas Transportation/Storage

- Gas Injection/Production
- Active/Monitor Valve Systems
- Compressor Antisurge
- Gas to Flare
- Fuel Gas Regulation
- Surge Relief
- Silencers



LNG

- Compressor Antisurge
- Acid Gas Separator
- Pump Recirculation Valves
- Hot Gas Bypass Valves
- Joule Thompson Valves
- Gas to Flare
- Emergency Depressurising Valves

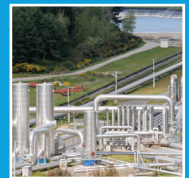

Petrochemical

- Compressor Antisurge
- Feed Gas Regulation
- Expander Bypass
- Process Gas Depressurising
- Gas to Flare
- Amine Pump Let Down and Recircs
- Aux Power Unit Valves
- Liquid Ammonia Let Downs

This is representative of the type of application where RAVEN trim can be used to ensure long trouble-free operation. This list is by no means exhaustive.

REDUCTION IN NOISE

Labyrinth type trims have been widely accepted over the last 25 years as being the best solution in cases where high noise and vibration are likely. Their wide acceptance is based on the principles of reducing mass flow and strictly controlling the velocity of the medium within the trim. Copes-Vulcan valve engineers have taken this technology one step further. They found that by splitting the outlet flow of each labyrinth path into three or more small mass flows (rather than the one large flow) noise could be reduced by up to 3 dBA more than in a similar design labyrinth with the same number of pressure reducing stages. Size for size, RAVEN has been proven quieter than the leading competitor in extensive laboratory testing.

RAVEN PROVIDES TRUE VELOCITY CONTROL

Copes-Vulcan’s RAVEN Control Valves offer a proven solution for severe service applications where a true velocity control trim is the best, or possibly the only, answer. The combined effect of numerous narrow flow channels, each with many sharp turns and a continually expanding flow path, is to remove kinetic energy from the fluid while gradually lowering its pressure. By limiting the fluid velocities inside the valve, RAVEN trim precludes problems typically associated with high velocity such as erosion, noise, vibration and poor control. The additional benefit for liquid flow is the elimination of cavitation and the damage it can do to a valve, its trim, and the downstream piping.

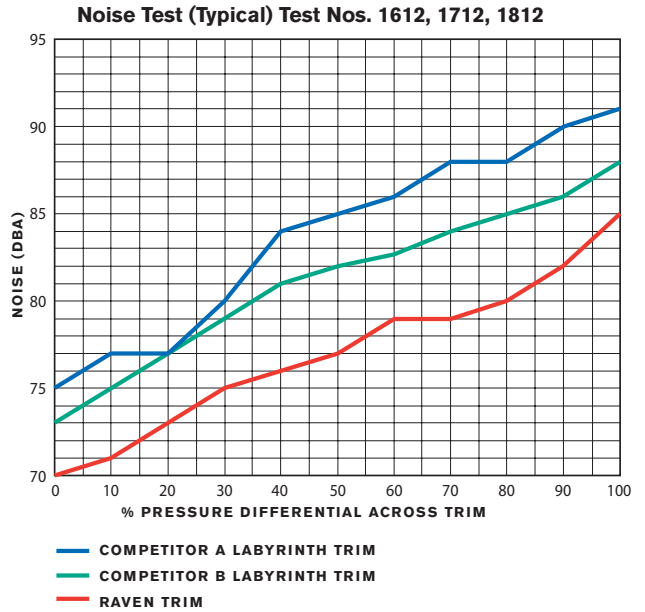

STACKED DISC TECHNOLOGY

RAVEN’s low velocities are achieved through the use of a trim cage made by bonding together a series of individual discs. Each disc has a pattern of carefully controlled orifices and channels with a multitude of sharp turns etched into its surface. As the trim’s plug travels within the cage, the fluid is throttled and forced to travel an extremely tortuous path with each turn effecting a stage of pressure drop.

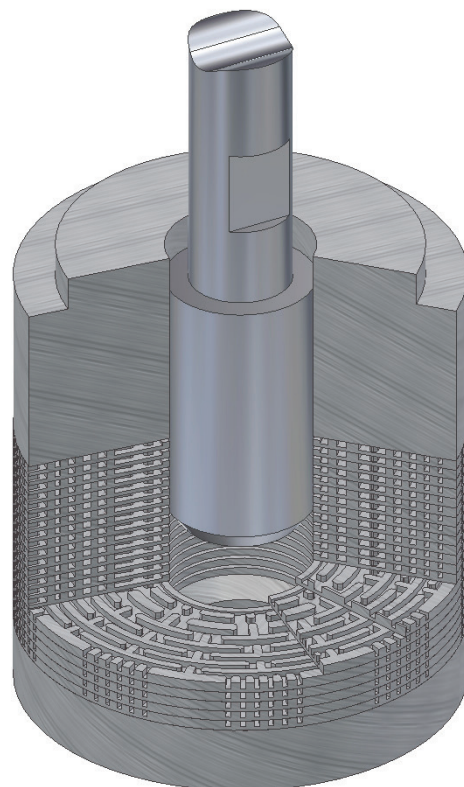

Trim Exit Velocity

SERVICE CONDITIONS	KINETIC ENERGY CRITERIA	EQUIVALENT WATER VELOCITY
	PSIA/KPA	FT/M PER SECOND
CONTINUOUS SERVICE, SINGLE PHASE FLUIDS	70 (450)	100 (30)
CAVITATING AND MULTI PHASE FLUID OUTLET (FLASHING)	40 (275)	75 (23)
VIBRATION SENSITIVE SYSTEM	11 (75)	40 (12)

NARROW WALL DESIGN ALLOWS MORE STAGES OF DROP PER DISC

By its very design, RAVEN™ trim allows for many more stages of drop than conventional tortuous path trims. Superior to other velocity control trims, RAVEN™, through the use of a consistent narrow wall design, typically is more efficient at passing flow or allowing more turns or stages of drop in a given valve size.

MANUFACTURED TO EXACTING TOLERANCES

By manufacturing the flow channels to extremely close tolerances, RAVEN's calculated or predicted versus actual pressure drops are significantly more accurate than competitors. Hence, velocities are more uniform throughout the entire trim, further guarding against noise, erosion and cavitation. The unique methods employed to produce the individual discs and then bond them together provide the uniform flow passages and a high strength stack assembly.

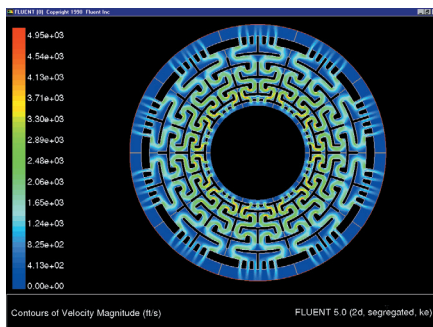

MULTIPLE RELIEF POINTS PREVENT BLOCKAGE

Most RAVEN™ trims contain multiple relief points in the flow path as a standard feature. These relief points allow entrained debris to clear the main fluid flow, or in the case of significant path blockage, they provide an effective bypass route of the fluid. With the benefits of the relief points being obvious, the actual fluid flow streams still remain virtually separate or discrete from each other for best velocity control.

SEVERE DUTY CONSTRUCTION WITH ACTUATOR OPTIONS

A RAVEN™ Control Valve typically consists of an SD Severe Duty valve operated by either a powerful Series 700 or 1000 pneumatic diaphragm actuator or a Series 200 piston actuator. When required, electric, electro-hydraulic, hydraulic or gas-powered actuators can also be supplied.

LONG-LIFE AND RELIABILITY

Due to the velocity control techniques utilized in RAVEN,™ vibration can be virtually eliminated. High velocity is a root cause of noise and vibration, which often can cause seal failure, instrumentation problems and cracking of valve components.

HIGH RANGEABILITY APPLICATIONS

Due to the characterization achievable within the disc stack, rangeabilities to 200:1 or as required by the application can be achieved. Wherever a split range, two valves in parallel installation is being considered using conventional valves, it is usually much more attractive, both commercially and technically, to combine both valves into a high rangeability RAVEN™ Control Valve. Typical applications include pipeline packing, boiler feed pumps, etc.

ANTISURGE VALVES

These valves require tight shutoff, fast-acting pneumatic control, low hysteresis, and since they can operate for extended periods, low noise. Operating speeds of one second can be reliably achieved using pneumatic actuation.

DEPRESSURIZING AND VENT VALVES

Since they operate normally in the closed position, a tight shutoff is critical to prevent valve degradation due to leakage. Copes-Vulcan has a well-proven zero leakage design seat that can be used together with RAVEN™ as required.

CUSTOM DESIGNED FOR EACH APPLICATION

Every RAVEN™ trim is custom designed to meet the needs of the toughest liquid, steam and gas services in the Oil and Gas, Petrochemical, Power and Process industries meeting NACE MR0175 where necessary. The number of pressure reducing stages is governed by two factors: velocity control and noise requirements. Either velocity or noise can be the factor determining the number of stages required. As per the latest ISA guidelines, RAVEN™ is designed to control velocity of the fluid within the trim to 100 ft./sec. (30m/s) (or the equivalent velocity head in case of gases). Dependent upon the differential pressure across the trim, the stages required to control the velocity are calculated. The lower the noise specification, the more stages required. The trim is also characterized to account for changes in flow and differential pressure at different valve openings.

ADAPTABLE FLOW DIRECTION

Flow can be either over or under the plug depending upon the fluid, the service and, in some instances, the piping configuration.

TIGHT SHUTOFF

Equipped with various plugs (eg. unbalanced, balanced, tandem, etc.), RAVEN™ can provide shutoff classes ranging from ANSI/FCI 70-2 Class IV to VI and MSS-SP-61. For particular applications Celeros can also supply our patented ZERO leakage design.

EASILY SERVICED

Quick-change design with no threaded or welded-in parts. Seat ring is a separate replaceable item.

RESISTS PLUGGING AND GALLING

A pressure-balancing groove inboard of the I.D. of each disc allows the plug to be completely balanced around its circumference, and provides a landing area for entrained debris, thus precluding plug galling. Additionally, bypasses in the flow path allow for entrained debris to clear the main fluid flow path.

RETROFITS/UPGRADES

RAVEN™ trim can be readily tailored to fit valves previously supplied with other trims styles, and valves manufactured by other suppliers. This has a cost benefit in that a new body is not required. This shortens delivery times considerably. Most refits can be carried out with the valve in position at site within one day.

TRIM RECOMMENDATIONS MATCHED TO THE APPLICATION

With the Copes-Vulcan brand, Celeros, unlike other manufacturers, offers a wide variety of performance-proven trim styles. This enables us to select the correct trim for every application without restriction. In applications requiring a high number of pressure reducing stages, RAVEN™ trim is the ideal solution. In less severe applications, a more economical trim style can be applied. It is our policy to quote the most economical trim that will satisfy a particular application.

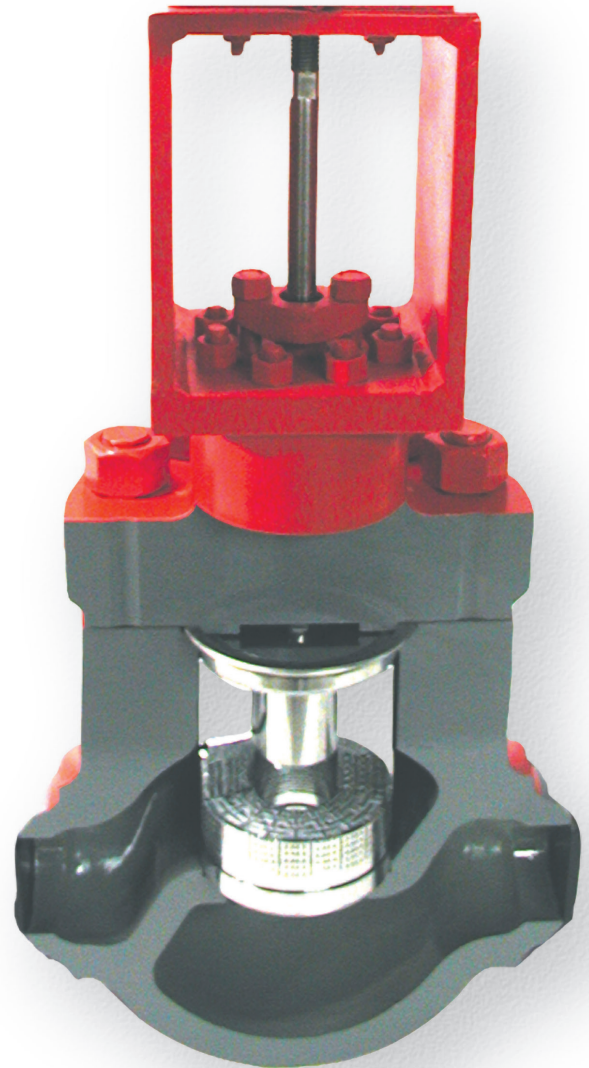

RAVEN™ Specifications

URNS/STAGES OF PRESSURE DROP

Application specific up to 60 or more

RANGEABILITY

100:1 or greater

TRIM CHARACTERISTICS

Equal percentage, linear or customized

VALVE SIZES

1.5–36" (38–914mm) and customized sizes

PRESSURE RATINGS

ANSI 150–4500

BODY STYLES

Straight-through globe, offset globe/Z pattern, angle style

BODY ENDS

Flanged, butt weld (to any standard or special requirement) or clamped

STANDARD TRIM MATERIALS

- Disc Stacks: 300 or 400 Series stainless steel, Inconel or other materials as required
- Plug & Seat: hardened 420 stainless steel, Stellite 316 stainless steel or other materials as required.

STANDARD BODY/BONNET MATERIALS

Carbon steel, chrome moly, stainless steel, and other castable or forged materials.

ACTUATORS:

- Series 1000 Pneumatic Diaphragm Actuators
- Series 200 Piston Actuators
- Electric
- Hydraulic Actuators
- Gas Powered Actuators
- Stepper Actuators

CODES & STANDARDS

Due to our specialist design capabilities, RAVEN™ Valves can be manufactured to meet virtually any standard in the world. Some of these standards are listed below:

ISO 9001

CE Accreditation

ASME Section 1 S Stamp

Section III N & NPT Stamps

Section III NCA 40C Stamp

CSA Z299.3 & Z299.4

MSSP61

NA V Ships 250–1500–1

ANSI B16.34, NQA 1, N45.2. B31.1

MIL I 45208A, Q9858, STD 2132

API 598



RAVEN™ TRIM

- | **SPEED**
- | **EXCELLENCE**
- | **PARTNERSHIP**

COPIES VULCAN®