

## **KIM001**

### **Piezo Inertia Motor Controller**

### **APT User Guide**



Original Instructions

# Contents

<b>Chapter 1</b>	<b>Introduction .....</b>	<b>1</b>
1.1	Introduction .....	1
1.2	Power Options .....	2
1.3	APT PC Software Overview .....	3
<b>Chapter 2</b>	<b>Safety .....</b>	<b>8</b>
2.1	Safety Information .....	8
2.2	General Warnings .....	8
<b>Chapter 3</b>	<b>Installation .....</b>	<b>9</b>
3.1	Install The Software .....	9
3.2	Mechanical Installation .....	10
3.3	Electrical Installation .....	11
3.4	Connect The Hardware .....	14
3.5	Selecting the Stage Type .....	15
3.6	Verifying Software Operation .....	16
3.7	Automatic Temperature Control During High Frequency Operation .....	16
<b>Chapter 4</b>	<b>Standalone Operation .....</b>	<b>17</b>
4.1	Introduction .....	17
4.2	Control Panel Buttons and Indicators .....	18
4.3	Zeroing .....	18
4.4	Wheel Operation .....	18
4.5	Settings Menu .....	20
4.6	Using the External Inputs .....	32
<b>Chapter 5</b>	<b>PC Operation - Tutorial .....</b>	<b>33</b>
5.1	Introduction .....	33
5.2	Using the APT User Utility .....	33
5.3	Zeroing .....	34
5.4	Moving to a Position .....	34
5.5	Changing Motor Parameters .....	35
5.6	Jogging .....	35
5.7	Graphical Control Of Motor Positions (Point and Move) .....	36
5.8	Setting Move Sequences .....	38
5.9	Creating a Simulated Configuration Using APT Config .....	41
<b>Chapter 6</b>	<b>Software Reference .....</b>	<b>44</b>
6.1	Introduction .....	44
6.2	GUI Panel .....	44
6.3	Settings Panel .....	45

---

---

## Appendices

<b>Appendix A Preventive Maintenance .....</b>	<b>54</b>
<b>Appendix B Specifications and Associated Parts .....</b>	<b>55</b>
<b>Appendix C Piezo Operation - Background .....</b>	<b>57</b>
<b>Appendix D Regulatory .....</b>	<b>60</b>
<b>Appendix E Thorlabs Worldwide Contacts .....</b>	<b>62</b>

# Chapter 1 Introduction

## 1.1 Introduction

The KIM001 Piezo Inertia Motor Controller is designed to control our series of piezo inertia-driven actuators and positioning stages. It offers 1 channel of stand-alone manual control for continuous movement/jogging and also remote PC control via USB. The product will support multiple external trigger functions, including position count and motion activity, as well as general purpose I/O.

Although compact in footprint, this unit offers a fully featured control capability including jog settings, "on the fly" changes in move direction, and, for more advanced operation, control over the number of steps performed.

The footprint of this unit has been kept to a minimum, measuring only 60 mm x 60 mm x 47 mm (2.36" x 2.36" x 1.85") and with the facility to directly mount to the optical table close to the devices being driven - convenient when manually adjusting positions using the top panel controls (jog buttons and velocity control slider). Table top operation also allows minimal drive cable lengths for easier cable management.



Fig. 1.1 K-Cube Piezo Inertia Motor Controller

USB connectivity provides easy 'Plug and Play' PC controlled operation - multiple units can be connected to a single PC via standard USB hub technology or by using the K-Cube Controller Hub (see below) for multi-axis control applications. Coupling this with the user friendly apt™ software (supplied) allows the user to very quickly get up and running with complex move sequences in a short space of time. Advanced

custom motion control applications and sequences are also possible using the extensive ActiveX® programming environment also supplied. This programming library is compatible with many development tools such as LabView, Visual Basic, Visual C++, C++ Builder, LabWindows/CVI, Matlab and Delphi.

In the remainder of this handbook, operation of the unit is described for both front panel and PC operation. Tutorial sections (Chapter 4 and Chapter 5) provide a good initial understanding on using the unit and reference section (Chapter 6) covers all operating modes and parameters in detail.

## 1.2 Power Options

For power, a single way wall plug supply (KPS101) is available for powering a single K-Cube Driver.

As a further level of convenience when using these controllers, Thorlabs also offers the K-Cube Controller Hubs (KCH301 and KCH601). These products have been designed specifically with multiple K-Cube operation in mind in order to simplify issues such as cable management, power supply routing and different optical table mounting scenarios. The KCH301 hub provides power distribution for up to three K-Cubes, while the KCH601 hub provides power distribution for up to six K-Cubes.

The Controller Hub comprises a slim base-plate type carrier with electrical connections located on the upper surface: the KCH301 measures 193.5 mm x 70.0 mm x 24.0 mm (7.62" x 2.76" x 0.94") and accepts up to three K-Cubes while the KCH601 measures 376.5 mm x 70.0 mm x 24.0 mm (14.82" x 2.76" x 0.94") and accepts up to six K-Cubes.

Internally the Controller Hub contains a fully compliant USB 2.0 hub circuit to provide communications for all K-Cubes – a single USB connection to the Controller Hub is all that is required for PC control. The Controller Hub also provides power distribution for the K-Cubes, requiring only a single power connection.



### Caution

Due to the nature of its design, and its non-linear high frequency switching, if the KIM001 unit is fitted to the hub and it is driven at high output frequencies, it may generate electrical noise which could affect the operation of other K-Cubes also fitted to the hub. If problems are experienced in this way, remove the KIM001 K-Cube from the hub and use a stand alone power supply.



### Caution

Do not use a power supply with damaged, cracked or split wires. In such cases, the supply could still power up the cube, but the integrity of the ground return may be compromised. This could result in a hazardous live voltage being generated.

Any obvious signs of damage to the power supply lead should result in immediate replacement of the PSU.

## 1.3 APT PC Software Overview

### 1.3.1 Introduction

As a member of the APT range of controllers, the K-Cube Piezo Inertia Motor Controller shares many of the associated software benefits. This includes USB connectivity (allowing multiple units to be used together on a single PC), fully featured Graphical User Interface (GUI) panels, and extensive software function libraries for custom application development.

The APT software suite supplied with all APT controllers, provides a flexible and powerful PC based control system both for users of the equipment, and software programmers aiming to automate its operation.

For users, the APTUser (see Section 1.3.2.) and APTConfig (see Section 1.3.3.) utilities allow full control of all settings and operating modes enabling complete 'out-of-box' operation without the need to develop any further custom software. Both utilities are built on top of a sophisticated, multi-threaded ActiveX 'engine' (called the APT server) which provides all of the necessary APT system software services such as generation of GUI panels, communications handling for multiple USB units, and logging of all system activity to assist in hardware trouble shooting. It is this APT server 'engine' that is used by software developers to allow the creation of advanced automated positioning applications very rapidly and with great ease. The APT server is described in more detail in Section 1.3.4.

#### *Aside*

*ActiveX®*, a Windows®-based, language-independent technology, allows a user to quickly develop custom applications that automate the control of APT system hardware units. Development environments supported by ActiveX® technology include Visual Basic®, LabView™, Borland C++ Builder, Visual C++, Delphi™, and many others. ActiveX® technology is also supported by .NET development environments such as Visual Basic.NET and Visual C#.NET.

*ActiveX controls are a specific form of ActiveX technology that provide both a user interface and a programming interface. An ActiveX control is supplied for each type of APT hardware unit to provide specific controller functionality to the software developer. See Section 1.3.4. for further details.*

### 1.3.2 APTUser Utility

The APTUser application allows the user to interact with a number of APT hardware control units connected to the host PC. This program displays multiple graphical instrument panels to allow multiple APT units to be controlled simultaneously.



All basic operating parameters can be altered and, similarly, all operations (such as motor moves) can be initiated. Settings and parameter changes can be saved and loaded to allow multiple operating configurations to be created and easily applied.

For many users, the APTUser application provides all of the functionality necessary to operate the APT hardware without the need to develop any further custom software. For those who do need to further customize and automate usage of the K-Cube Piezo Motor Driver (e.g. to implement a positioning algorithm), this application illustrates how the rich functionality provided by the APT ActiveX server is exposed by a client application.

Use of the APT User utility is covered in the PC tutorial (Chapter 5) and in the APTUser online help file, accessed via the F1 key when using the APTUser utility.

### 1.3.3 APT Config Utility

There are many system parameters and configuration settings associated with the operation of the APT Server. Most can be directly accessed using the various graphical panels, however there are several system wide settings that can be made 'off-line' before running the APT software. These settings have global effect; such as associating mechanical stages to specific motor actuators and incorporation of calibration data.

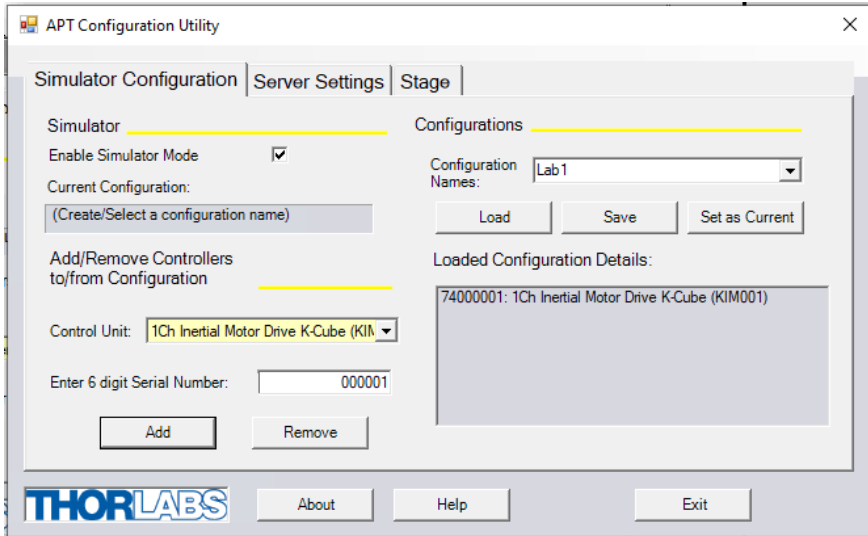

The APTConfig utility is provided as a convenient means for making these system wide settings and adjustments. Full details on using APTConfig are provided in the online help supplied with the utility.

Use of the APT Config utility is covered in the PC tutorial (Chapter 5) and in the APTConfig online help file, accessed via the F1 key when using the APTConfig utility.



### 1.3.4 APT Server (ActiveX Controls)

ActiveX Controls are re-usable compiled software components that supply both a graphical user interface and a programmable interface. Many such Controls are available for Windows applications development, providing a large range of re-usable functionality. For example, there are Controls available that can be used to manipulate image files, connect to the internet or simply provide user interface components such as buttons and list boxes.

With the APT system, ActiveX Controls are deployed to allow direct control over (and also reflect the status of) the range of electronic controller units, including the Piezo Motor Driver K-Cube. Software applications that use ActiveX Controls are often referred to as 'client applications'. Based on ActiveX interfacing technology, an ActiveX Control is a language independent software component. Consequently ActiveX Controls can be incorporated into a wide range of software development environments for use by client application developers. Development environments supported include Visual Basic, Labview, Visual C++, C++ Builder, HPVEE, Matlab, VB.NET, C#.NET and, via VBA, Microsoft Office applications such as Excel and Word.

Consider the ActiveX Control supplied for the APT Piezo Motor driver unit.



This Control provides a complete user graphical instrument panel to allow the piezo inertia motor unit to be manually operated, as well as a complete set of software functions (often called methods) to allow all parameters to be set and motor operations to be automated by a client application. The instrument panel reflects the current operating state of the controller unit to which it is associated (e.g. such as motor position). Updates to the panel take place automatically when a user (client) application is making software calls into the same Control. For example, if a client application instructs the associated Piezo motor Control to move a motor, the progress of that move is reflected automatically by changing position readouts on the graphical interface, without the need for further programming intervention.

The APT ActiveX Controls collection provides a rich set of graphical user panels and programmable interfaces allowing users and client application developers to interact seamlessly with the APT hardware. Each of the APT controllers has an associated ActiveX Control and these are described fully in system online help or the handbooks associated with the controllers. Note that the APTUser and APTConfig utilities take advantage of and are built on top of the powerful functionality provided by the APT ActiveX Server (as shown in Fig. 1.2).

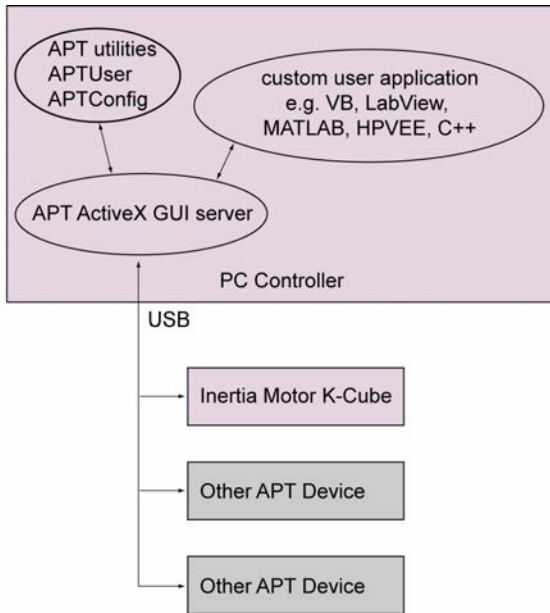

**Fig. 1.2 System Architecture Diagram**

Refer to the main APT Software online help file, for a complete programmers guide and reference material on using the APT ActiveX Controls collection. This is available either by pressing the F1 key when running the APT server, or via the Start menu, Start\Programs\Thorlabs\APT\APT Help.

### 1.3.5 Software Upgrades

Thorlabs operate a policy of continuous product development and may issue software upgrades as necessary. The latest software can be downloaded from the 'services' section of [www.thorlabs.com](http://www.thorlabs.com). A utility is provided with the APT Software to assist in firmware upgrades.

**Note**

When the firmware is updated, the cooling fans may increase in speed while the unit is reprogrammed.

## Chapter 2 Safety

### 2.1 Safety Information

For the continuing safety of the operators of this equipment, and the protection of the equipment itself, the operator should take note of the **Warnings, Cautions** and **Notes** throughout this handbook and, where visible, on the product itself.

The following safety symbols may be used throughout the handbook and on the equipment itself.

**Warning: Risk of Electrical Shock**

Given when there is a risk of injury from electrical shock.

**Warning**

Given when there is a risk of injury to users.

**Caution**

Given when there is a risk of damage to the product.

**Note**

Clarification of an instruction or additional information.

### 2.2 General Warnings

**Warning**

If this equipment is used in a manner not specified by the manufacturer, the protection provided by the equipment may be impaired. In particular, excessive moisture may impair operation.

This product generates, uses and outputs high voltages from the SMC connector (HV Output) that are hazardous and can cause serious injury. In any installation that uses the KIM001 it is the user's responsibility to ensure adequate insulation and precautions are taken to avoid shock risk. Cables for HV Out must be rated for 250 V RMS.

Spillage of fluid, such as sample solutions, should be avoided. If spillage does occur, clean up immediately using absorbant tissue. Do not allow spilled fluid to enter the internal mechanism.

## Chapter 3 Installation

### 3.1 Install The Software

#### Note

This section is applicable only if the K-Cube is to be used with a PC. If your application consists only of local operation via the K-Cube front face, proceed to Chapter 4.

When operating via a PC, direct user interaction with the Piezo driver is accomplished through intuitive graphical user interface panels (GUIs), which expose all key operating parameters and modes. The user can select multiple panel views displaying different information about a particular hardware unit. The multitasking architecture ensures that the graphical control panels always remain live, showing all current hardware activity.



#### Caution

Some PCs may have been configured to restrict the users ability to load software, and on these systems the software may not install/run. If you are in any doubt about your rights to install/run software, please consult your system administrator before attempting to install.

If you experience any problems when installing software, contact Thorlabs on +44 (0)1353 654440 and ask for Technical Support.

#### **DO NOT CONNECT THE CONTROLLER TO YOUR PC YET**

- 1) Go to Services/Downloads at [www.thorlabs.com](http://www.thorlabs.com) and download the APT software.
- 2) Run the .exe file and follow the on-screen instructions.

## 3.2 Mechanical Installation



### Warning

The safety of any system incorporating this equipment is the responsibility of the person performing the installation.

### 3.2.1 Environmental Conditions



### Warning

Operation outside the following environmental limits may adversely affect operator safety.

Location Indoor use only

Maximum altitude 2000 m

Temperature range 5°C to 40°C

Maximum Humidity Less than 80% RH (non-condensing) at 31°C

To ensure reliable operation the unit should not be exposed to corrosive agents or excessive moisture, heat or dust.

If the unit has been stored at a low temperature or in an environment of high humidity, it must be allowed to reach ambient conditions before being powered up.

### 3.2.2 Mounting Options

The K-Cube Piezo Motor Controller is shipped with a baseplate, for use when fitting the unit to a breadboard, optical table or similar surface.

For multiple cube systems, a 3-channel and 6-channel K-Cube Controller Hub (KCH301 and KCH601) are also available - see Section 1.2. for further details. Full instructions on the fitting and use of the controller hub are contained in the handbook available at [www.thorlabs.com](http://www.thorlabs.com).



### Caution

When siting the unit, it should be positioned so as not to impede the operation of the control panel buttons.

To help minimize the risk of overheating, ensure that proper airflow is maintained to the front, rear and sides of the unit.

### 3.2.3 Using the Baseplate

The baseplate is supplied with magnets for quick positioning on an optical worksurface. For more secure positioning, it can be bolted to the worksurface before the K-Cube is fitted, as shown below. The K-cube is then located on two dowels in the baseplate and secured by two clips.

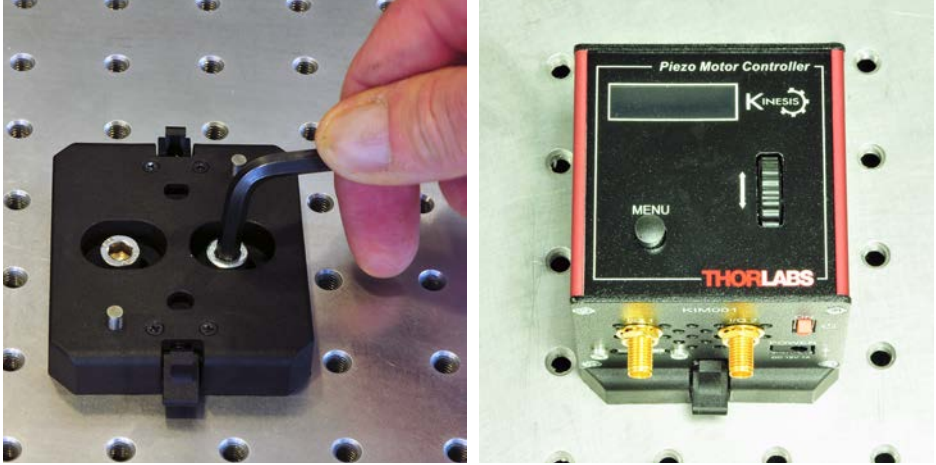

Fig. 3.1 Using The Baseplate

## 3.3 Electrical Installation



### Caution

Ensure that all USB and electrical cables are positively connected and all joints tightened. Loose connections can cause noise and interference problems due to transients from the high switching frequencies within the unit

### 3.3.1 Front Panel Connections

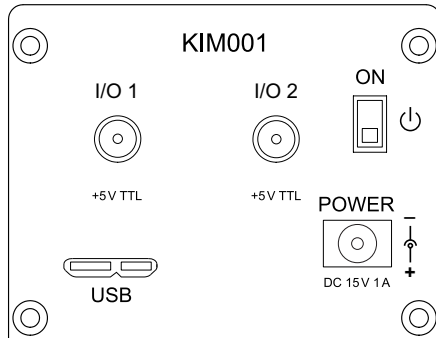

Fig. 3.2 Front Panel

**Warning: Risk of Electrical Shock**

The unit must be connected only to a DC supply of 15V, 1A regulated. Connection to a supply of a different rating may cause damage to the unit and could result in injury to the operator.

**POWER** - A Standard 3.5 mm front panel jack connector for connecting the unit to a regulated DC power supply of 15 V, 1A. See Section 1.2. for details on power supply options.

**Caution**

Do not use a power supply with damaged, cracked or split wires. In such cases, the supply could still power up the cube, but the integrity of the ground return may be compromised. This could result in a hazardous live voltage being generated.

Any obvious signs of damage to the power supply lead should result in immediate replacement of the PSU.

**USB** - USB port for system communications.

**Note**

The USB cable length should be no more than 3 metres unless a powered USB hub is being used.

**ON** - Power ON/Standby switch. When in the ON position, the unit is fully powered up. When the switch is turned to the Standby position, the unit initiates a controlled power down sequence, saving all user-adjustable parameters to non-volatile memory before turning off the power. For the first few seconds, the shutdown can be cancelled by turning the switch on again, in which case the unit will save the parameters but will remain powered up. In a powered down (Standby) state, the logic circuits are powered off and the unit will draw only a small quiescent current. The switch should always be used to power down the unit.

**I/O 1 and I/O 2** - SMA connectors for use with external trigger input and output signals (5V TTL levels). Units are shipped with I/O functionality disabled. The function is set to trigger IN or OUT via the GUI settings panel - see Section 6.3.

**Caution**

Do not connect the piezo unit to a 'live' external power supply. Doing so (i.e. "hot plugging") carries the risk of PERMANENT damage to the unit. Always ensure the power supply unit is isolated from the mains and the front panel switch turn OFF before connecting to the piezo unit.

Always power up the piezo unit by connecting its power supply to the mains then switch ON using the front panel switch. Similarly, to power down the unit, turn the front panel switch OFF, then disconnect the power supply from the mains before disconnecting the piezo unit.



**Caution**

To avoid overheating the unit, do not turn off the power until the fan has stopped. This can take several minutes if high frequency stage moves have been performed.

3.3.2 Rear Panel Connections

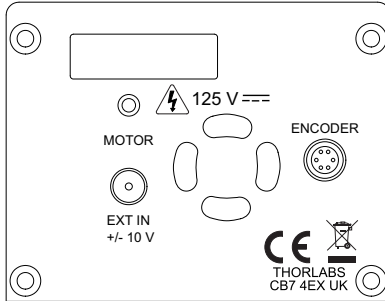

**Fig. 3.3 Rear Panel Connections**

**EXT IN** - (SMA Connector) Analog input, used to control the velocity of the piezo actuator from an external source. This input allows an external signal to drive the output to its full scale velocity in either direction. A -10V input gives max velocity in the reverse direction, whereas +10V input gives max velocity forwards; a 0V input results in no movement.

See Section 4.6. for information on how to enable control via these analog inputs.

**MOTOR** - (SMC Connector) Drive connector compatible with all Thorlabs inertial piezo motor driven positioning stages and actuators (PIA series).



**Caution**

When making connections to the MOTOR terminal, take care to ensure proper alignment of the connectors before tightening. If resistance is felt the pins may be misaligned and could bend/break if the connection is forced.

The PIA series piezo inertia actuators are shipped with 1.1 m (3.3') of cable. Thorlabs offer 1.5m extension cables (PAA101) and male adapters (T5026) to extend the drive cable length to 2.5m, see [www.thorlabs.com](http://www.thorlabs.com).

Due to the capacitance of the cables, do not use cables longer than 2.5 m in total.

**ENCODER** - (6-Pin Hi-Rose Connector Female) **FOR FUTURE USE.** The 'ENCODER' connector is for future use in closed loop applications and provides a means of supplying feedback from an external source. Functionality will be enabled in Firmware revisions when compatible hardware is available.



### 3.3.3 Using The Controller Hub

The KCH301 and KCH601 USB Controller Hub provides power distribution for up to six K-Cubes, and requires only a single power connection. Further details are contained in handbook *ha0366T, K-Cube Controller Hub*, supplied with the unit.

**Warning**

DO NOT PLUG A POWERED UP K-Cube INTO THE KCH301 and KCH601 USB CONTROLLER HUB. Always ensure that all power is disconnected from the K-Cube AND the hub before the K-Cube is plugged into the hub. Failure to observe this precaution will seriously damage the K-Cube unit and could result in personal injury.

**Caution**

Due to the nature of its design, and its non-linear high frequency switching, if the KIM001 unit is fitted to the hub and it is driven at high output frequencies, it may generate electrical noise which could affect the operation of other K-Cubes also fitted to the hub. If problems are experienced in this way, remove the KIM001 K-Cube from the hub and use a stand alone power supply.

### 3.3.4 Powering Down The Unit

**Caution**

To avoid overheating the unit, do not turn off the power until the fan has stopped.

## 3.4 Connect The Hardware

- 1) Perform the mechanical installation as detailed in Section 3.2.
- 2) Install the APT Software.
- 3) Connect the Controller unit to your PC.

**Note**

The USB cable should be no more than 3 metres in length. Communication lengths in excess of 3 metres can be achieved by using a powered USB hub).

- 4) Connect the Piezo motor stage to the Controller unit - see Section 3.3.2.

**Caution**

During item (5) ensure the power supply unit is isolated from the mains before connecting to the K-Cube unit. Always power up the K-Cube unit by connecting its power supply to the mains. DO NOT connect the K-Cube unit to a 'live' external power supply. Doing so (i.e. "hot plugging") carries the risk of PERMANENT damage to the unit. Similarly, to power down the unit, disconnect the power supply from the mains before disconnecting the K-Cube unit.

- 5) Connect the Controller unit to the power supply - see Section 3.3.1.

6) Connect the PSU to the main supply and switch 'ON'.



**Caution**

During initialization at power up, checks are carried out on any actuators connected to the controller. If any faults are detected an error message is indicated on the LCD screen and the unit should be powered down immediately.

7) Switch 'ON' the unit using the switch on the front panel.

8) Windows™ should detect the new hardware. Wait while Windows™ installs the drivers for the new hardware.

The unit takes about 5 seconds from power application until initialization is finished, during which time the firmware revision and the stage type last selected are displayed.

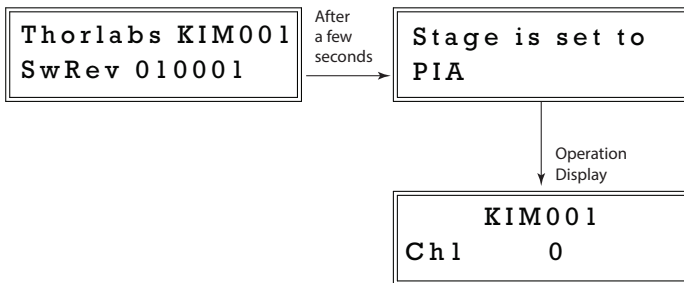

**Fig. 3.4 KIM001 start up screen**

After initialization, the displays shows the device part number (KIM001) and the position is steps from the zero position.

### 3.5 Selecting the Stage Type

To ensure that a particular stage is driven properly by the system, a number of parameters must first be set. These parameters relate to the physical characteristics of the stage/actuator being driven (e.g. min and max positions, leadscrew pitch, homing direction etc.).

To assist in setting these parameters correctly, it is possible to associate a specific stage type with the motor controller. Once this association has been made, the server automatically applies suitable default parameter values on boot up of the software.

**Note**

To ensure correct operation, it is important to select the correct stage and axis type as described above. Selecting an incompatible stage/axis type could result in reduced velocity and/or resolution, and in the worst case could cause the stage to run into the end stops.

The stage type can only be selected from the top panel settings menu - see Section 4.5.11. for more details.

### 3.6 Verifying Software Operation

The APT Software should be installed (Section 3.1.) and the controller connected to the actuators (see Section 3.4.) and the PC, before verifying software operation.

- 1) Run the APTUser utility and check that the Graphical User Interface (GUI) panel appears and is active.



Fig. 3.5 GUI panel showing jog and ident buttons

- 2) Click the 'Ident' button. The display on the top panel of the associated controller flashes. This is useful in multi-channel systems for identifying which unit is associated with which GUI.
- 3) Click the green Enable button next to the main display to enable the drive channel.
- 4) Click the jog buttons on the GUI panel to move the actuator associated with the selected unit. The step count display for the associated GUI should increment and decrement accordingly.

Follow the tutorial described in Chapter 5 for further guidance on basic operation.

### 3.7 Automatic Temperature Control During High Frequency Operation



#### Caution

During high frequency operation over a prolonged period of time, the unit can become quite hot. During this operation, the unit temperature is continually monitored by an internal sensor circuit. If the heat generated becomes excessive, the internal circuit may trip and reduce the drive frequency until the unit has cooled down. In extreme operating conditions the unit may be disabled and an error message generated on the top panel.

## Chapter 4 Standalone Operation



### **Warning: Risk of Electrical Shock**

Persons using the KIM001 controller must understand the hazards associated with using high voltages and the steps necessary to avoid risk of electrical shock. If the KIM001 is used in a manner not specified by Thorlabs, the protective features provided by the product may be impaired.

### 4.1 Introduction

The K-Cube Piezo Inertia Motor Driver has been designed specifically to operate with the latest range of Thorlabs piezo inertia motor driven products. The unit offers a fully featured control capability including max drive voltage settings, step rate and step acceleration, allowing support for many different actuator configurations. These parameters can be set via the APT software - see Chapter 6. Furthermore, many of these parameters are automatically set to allow “out of the box” operation with no further “tuning” required.

The following brief overview explains how the front panel controls can be used to perform a typical series of motor moves. It is assumed that the unit has already been installed and configured for the particular actuator or stage connected - see Chapter 3 for more details.

## 4.2 Control Panel Buttons and Indicators

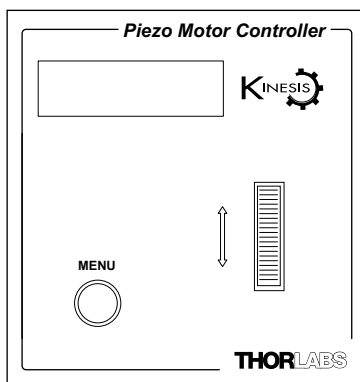

Fig. 4.1 Panel Controls and Indicators

These controls allow all operations to be initiated.

*Wheel* - Used to move the piezo motor - see Section 4.4. Also used to move through the various set up menu options - see Section 4.5.

*Digital Display* - Under normal operation, the display shows the step count of the motor, together with the motor channel currently selected. It also shows the menu options and settings, accessed via the menu button - see Section 4.5. When the Ident button on the associated GUI panel is clicked, the display text 'KIM001' at the top of the display will flash for a short period.

MENU - used to access the settings menu - see Section 4.5.

## 4.3 Zeroing

To establish a datum from which subsequent moves can be measured, move the motor to the required zero position. The position count can then be zeroed in the Zero Axis option in the Settings Menu - see Section 4.5.3.

The counter can also be zeroed by clicking the ZERO button on the GUI panel (see Section 5.3.), or by calling the appropriate message in the APT software).

## 4.4 Wheel Operation

The wheel on top of the unit provides multi-function operation. In normal use the wheel is used to move the motor, at a velocity that is proportional to its deflection from the central position. In this central position the piezo inertia motor is stationary. As the wheel is moved away from the center, the motor begins to move. Directional control of the motor is achieved by moving the wheel up and down.

The wheel can be used to control the motor in a number of ways as follows, depending on the mode selected in the wheel Mode menu option - see Section 4.5.6.



**Caution**

If the actuator is driven into its physical end stops, the motor may stick and may not respond to subsequent motion demands. If this is the case, turn the adjustment knob of the actuator manually to move the device away from its end stop, then the motor should move normally.

#### 4.4.1 Jog to Count

In 'Jog to Count' mode, the wheel can be programmed with two position values, one for each direction of deflection, such that the controller will move the motor to that position when the wheel is moved. In this mode, move the wheel up to go to position 1, and down to go to position 2.

These 'taught' positions can be set through the Teach Position option in the settings menu - see Section 4.5.7. or through the software GUI - see Section 6.3.

This mode of operation is enabled in the Settings Menu by setting the 'wheel Mode' option to 'Jog to Count' - see Section 4.5.6. It can also be selected in the wheel Mode parameter on the Panel tab in the GUI Settings panel - see Section 6.3.2. for further information.

#### 4.4.2 Jogging

The top panel wheel can also be configured to 'jog' the motor. This mode of operation is enabled by setting the wheel Mode menu option to 'Jogging in Steps' - see Section 4.5.6. or by setting the 'wheel Mode' parameter to 'Jog' on the 'Panel' settings tab - see Section 6.3.2.

Once set to this mode, the jogging parameters (step size, step rate etc) are taken from the 'Jog Settings' parameters on the Move/Jogs settings tabs - see Section 6.3.1. or from the Jog Step Size option in the panel settings menu.

#### 4.4.3 Velocity Control

When Velocity Control mode is selected, the speed of the motor increases as a function of deflection. The maximum speed is entered in the 'Max Step Rate' parameter in the 'Device Control Options' parameters on the Device settings tabs - see Section 6.3.1.

## 4.5 Settings Menu

### 4.5.1 Overview

After the power up sequence is complete, the normal operating screen is displayed.

Press the MENU button to enter the settings mode.

Use the wheel to scroll through the menu options

Press the MENU button to enter a particular option

Go to position count - see Section 4.5.2.

Zero the selected axis - see Section 4.5.3.

Set the move velocity- see Section 4.5.4.

Set the jog step size- see Section 4.5.5.

Set the wheel mode - see Section 4.5.6.

Teach the go to positions - see Section 4.5.7.

Enable or disable the drive axis - see Section 4.5.8.

Set the display brightness - see Section 4.5.9.

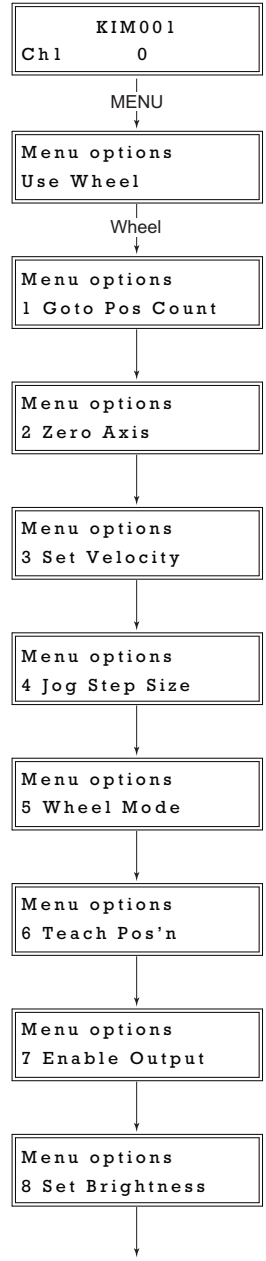

Overview (Cont)...

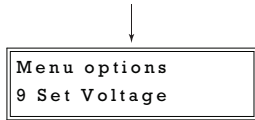

Set the voltage - see Section 4.5.10.

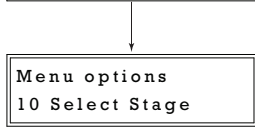

Select the stage - see Section 4.5.11.

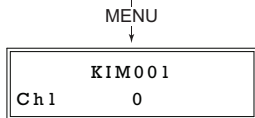

Press MENU to return to the operating screen



#### 4.5.2 Menu Option - Go to position count

This option is used to move the motor associated with the controller to a specific position. The position is measured in cycles (pulses) relative to the zero position, in the range -100000 to 100000.

Press the MENU button, then use the wheel to scroll through the menu options.

Press the MENU button to enter the *Go to Pos Count* option.

Use the wheel to set the required position count, in the range -100000 to +100000.

Press the MENU button to save the setting and return to the operating screen.

The display shows position count, which counts up or down until the target is reached.

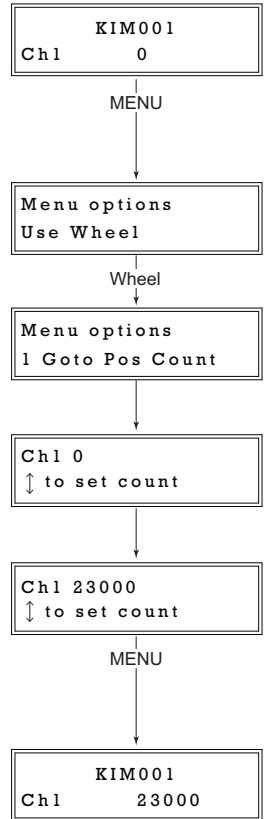

KIM001  
Ch1 23000

MENU

Menu options  
Use Wheel

Wheel

Menu options  
2 Zero Axis

MENU

Zero Ch1  
2 Zero Axis

MENU

KIM001  
Ch1 0

### 4.5.3 Menu Option - Zero Axis

Zeroing is equivalent to homing in a stepper or DC motor in that it establishes a datum from which subsequent position moves can be measured. Unlike these other motors however, the piezo motor can be zeroed anywhere along its travel.

Press the MENU button, and use the wheel to scroll through the menu options.

Press the MENU button to enter the Zero Axis option.

Press the MENU button to zero the channel and return to the main display.

The display shows the zeroed position count.

#### 4.5.4 Menu Option - Set Velocity

This option is used to set the max velocity when a move command is initiated via the GUI panel or via software. It is not applicable to moves initiated by the wheel (see Section 6.3.1.).

The piezo motor moves by ramping up the drive voltage to the value set in the Peak Voltage parameter (see Section 4.5.10.) and then dropping quickly to zero. This cycle is then repeated (see Fig. 6.3).

The velocity is specified in cycles/sec, in the range 1 to 2,000.

Press the MENU button, then use the wheel to scroll through the menu options.

Press the MENU button to enter the Set Velocity option.

Use the wheel to adjust the velocity, in the range 1 to 2,000 cycles/sec.

Press the MENU button to save the setting and return to the main operating display.

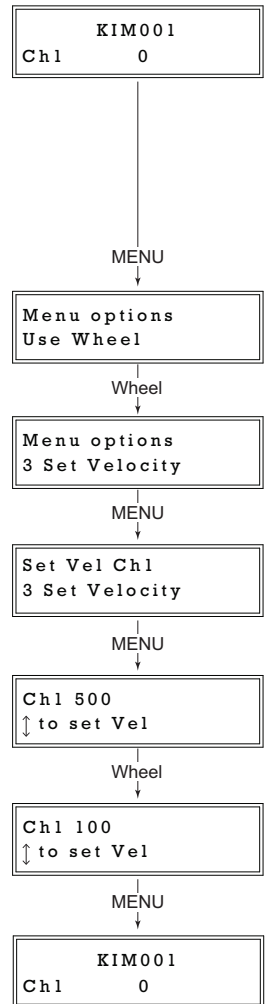

#### 4.5.5 Menu Option - Set Jog Step Size

KIM001  
Ch1 0

MENU

Menu options  
Use Wheel

Wheel

Menu options  
4 Set Jog Step Size

MENU

Ch1 Fwd 200  
↑ ↓ to set Step

MENU

Ch1 Rev 500  
↑ ↓ to set Step

MENU

KIM001  
Ch1 0

This option is used to set the distance moved when a jog command is initiated. The step size is specified by the 'number of cycles' (or pulses)' (see Section 6.3.1.), in the range 1 to 2,000.

The optimum step size depends on several parameters including the resistive torque against which the actuator tip is pushing, the drive voltage, the step rate, active preload, variance in the frictional behaviour of assembly components, the direction of actuation and the condition of the actuator.

Press the MENU button, then use the wheel to scroll through the menu options.

Press the MENU button to enter the Set Jog Step Size option.

Use the wheel to adjust the forward jog step size, in the range 0 to 2,000 cycles.

Press the MENU button to save the setting.

Use the wheel to adjust the reverse jog step size, in the range 0 to 2,000 cycles.

Press the MENU button to save the setting and return to the main operating display.

#### 4.5.6 Menu Option - Wheel Mode

This option is used to set the operating mode of the top panel wheel, as detailed in Section 4.4.

In all modes, directional control of the motor is achieved by moving the wheel up and down.

Press the MENU button, then use the wheel to scroll through the menu options.

Press the MENU button to enter the Wheel Mode option.

Use the wheel to select the required mode.

In '*Jog to Count*' mode, the wheel can be programmed with two position values, one for each direction of deflection, such that the controller will move the motor to that position when the wheel is moved. In this mode, move the wheel up to go to position 1, and down to go to position 2.

These 'taught' positions are set through the Teach Position option - see Section 4.5.7.

In *Jog in Steps* mode, the motor moves one jog step for each deflection of the wheel. The jog step size is set in the Set Jog Step Size menu option - see Section 4.5.5. or in the 'Move/Jogs' settings tab - see Section 6.3.1.

When *Velocity* mode is selected, the speed of the motor increases as a function of deflection. The maximum speed is entered as a Step Rate value in the 'Max Step Rate' parameter in the 'Device Control Options' parameters on the Device settings tabs - see Section 6.3.1.

Press the MENU button to save the mode selected and return to the operating screen.

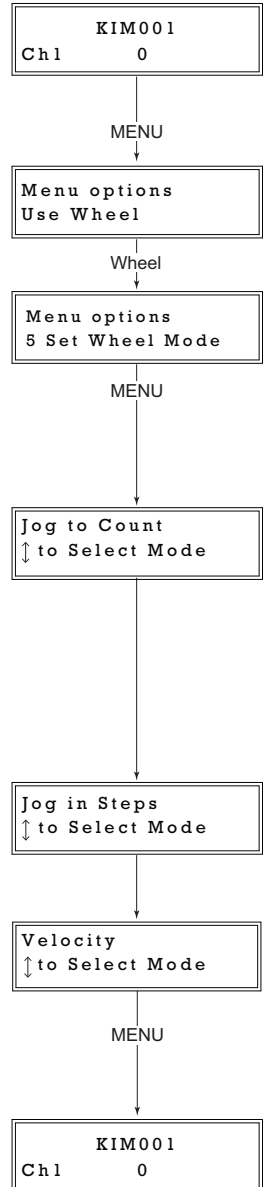

#### 4.5.7 Menu Option - Teach Positions

```
KIM001
Ch1  0
```

MENU

```
Menu options
Use Wheel
```

Wheel

```
Menu options
6 Teach Pos'n
```

MENU

```
Ch1 1000
↑↓ Teach Ch1 Pos1
```

MENU

```
Ch1 -1000
↑↓ Teach Ch1 Pos2
```

MENU

```
KIM001
Ch1  0
```

This option is used to set the move positions, when the wheel mode is set to 'Jog to Count' mode (see Section 4.5.6.).

Positions are measured in cycles' (or pulses)' from the zero position (see Section 6.3.1.).

Press the MENU button, then use the wheel to scroll through the menu options.

Press the MENU button to enter the Teach Pos'n option.

Use the wheel to set Pos1 (in steps from the zero position), then press the MENU button to save. The motor will move to this position when the wheel is moved Up.

Use the wheel to set Pos2 (in steps from the zero position), then press the MENU button to save. The motor will move to this position when the wheel is moved Down.

Press MENU to save the settings and return to the operating screen.

#### 4.5.8 Menu Option - Enable Output

This option is used to enable and disable the motor axis from the top panel.

Press the MENU button, then use the wheel to scroll through the menu options.

Press the MENU button to enter the Enable Output Mode option.

Use the wheel to select *Enable Ch1* or *Disable Ch1* as required.

Press the MENU button to save the selection and return to the operating mode.

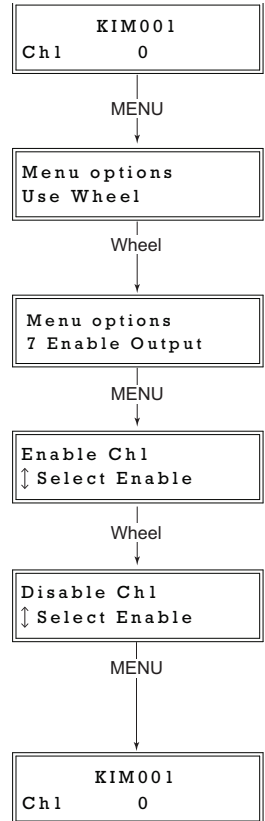

#### 4.5.9 Menu Option - Set Brightness

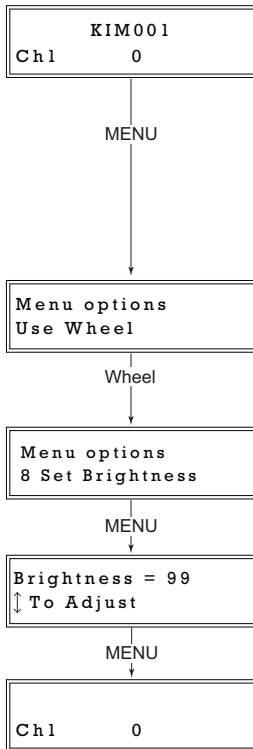

In certain applications, it may be necessary to adjust the brightness of the LCD display. The brightness is set as a value from 0 (Off) to 99 (brightest). The display can be turned off completely by entering a setting of zero, however, pressing the MENU button on the top panel will temporarily illuminate the display at its lowest brightness setting to allow adjustments. When the display returns to its default position display mode, it will turn off again.

Press the MENU button, then use the wheel to scroll through the menu options.

Press the MENU button to enter the Brightness option.

Use the wheel to adjust the brightness, in the range 0 (off) to 99 (brightest).

Then press the MENU button to store the selection and return to the main display.



#### 4.5.10 Menu Option - Set Voltage

This option is used to set the maximum piezo drive voltage applied to the actuators in the range 85V to 125V.

Press the MENU button, then use the wheel to scroll through the menu options.

Press the MENU button to enter the Set Voltage option.

Use the wheel to adjust the max drive voltage, in the range 85 to 125 V.

Then press the MENU button to store the selection and return to the main display.

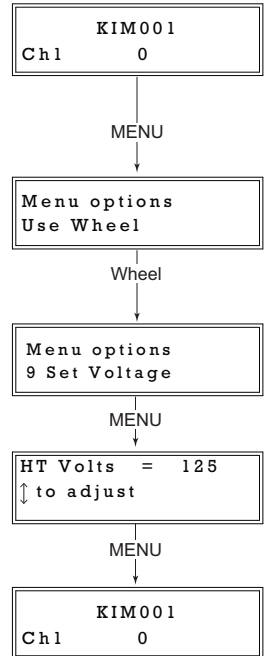

#### 4.5.11 Menu Option - Select Stage

This option allows the type of stage/actuator being driven to be selected. Once this selection has been made, the server automatically applies suitable default parameter values on boot up of the software

It is important to select the correct stage and axis type. Selecting an incompatible stage/axis type could result in reduced velocity and/or resolution, and in the worst case could cause the stage to run into the end stops.

Press the MENU button, then use the wheel to scroll through the menu options.

Press the MENU button to enter the Select Stage option.

Use the wheel to select the stage being driven, either 'PIA' for our PIA series Inertial Piezo Actuators, or PD(R) for one of our PD series Inertial Piezo Stages. The stage type selected is displayed on start up - see Fig. 3.4.

Then press the MENU button to store the selection and return to the main display.

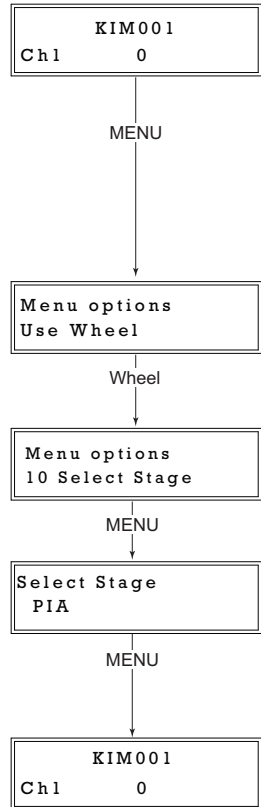

## 4.6 Using the External Inputs

The EXT IN connector on the rear panel (see Fig. 3.3) can be used to control the velocity of the piezo actuator by using a voltage input from an external source.

A -10V input gives max velocity in the reverse direction, whereas +10V input gives max velocity forwards; a 0V input results in no movement.

To use the external inputs, the user should apply a signal of  $0V \pm 0.25 V$  to the connector and wait 10 to 12 seconds for the unit to recognize a steady 0V input. After this time, the drive channel can be controlled by varying the voltage from -10V (max velocity reverse) to 10 V (max velocity forwards). A 0V input results in no movement.

### **Note**

The external inputs cannot be used in conjunction with the wheel or GUI panels.

If the unit recognizes a 0V signal on the EXT IN connector for around 12 seconds it will accept this as the controlling input. If subsequently, a move is performed via the GUI panel or wheel, this will inhibit the analog input. However, if the 0V signal remains, and no further GUI or wheel moves are performed, the external analog input will again become active after 12 secs.

To disable completely the analog control, disable the relevant axis, then remove the analog input, then re-enable the axis.

# Chapter 5 PC Operation - Tutorial

## 5.1 Introduction

The following brief tutorial guides the user through a typical series of moves and parameter adjustments performed using the PC based APT software. It assumes that the unit is electrically connected as shown in Section 3.3.2. and that the APT Software is already installed - see Section 3.1.

## 5.2 Using the APT User Utility

The APT User.exe application allows the user to interact with any number of APT hardware control units connected to the PC USB Bus (or simulated via the APTConfig utility). This program allows multiple graphical instrument panels to be displayed so that multiple APT units can be controlled. All basic operating parameters can be set through this program, and all basic operations (such as motor moves) can be initiated. Hardware configurations and parameter settings can be saved, which simplifies system set up whenever APT User is run up.



Fig. 5.1 Typical APT User Screen

- 1) Run the APT User program - Start/Programs/Thorlabs/APT/APT User.

2) The GUI panel shown below is displayed..



Fig. 5.2 Piezo Motor K-CubeSoftware GUI

The APT User utility will be used throughout the rest of this tutorial to interface with the piezo inertia motor controller.

### 5.3 Zeroing

To establish a datum from which subsequent position moves can be measured, move the motor to the required zero position, and then click the ZERO button on the GUI panel. The motor can also be zeroed from the hardware unit by using the Zero Axis menu option (see Section 4.5.3.).

### 5.4 Moving to a Position

Moves are measured in the number of steps, relative to the zero position.

- 1) Click the position display.



Fig. 5.3 Position Pop up Window

- 2) Enter the required number of steps into the pop up window, e.g. 128
- 3) Click 'OK'. Notice that the position display counts up to 128 to indicate a move to the absolute position commanded.

## 5.5 Changing Motor Parameters

The velocity settings relate to the maximum velocities at which a move is performed, and the acceleration at which the motor speeds up from zero to maximum velocity. Moves are performed using the drive velocity parameters set in the Move/Jogs tab (see Section 6.3.1.).

## 5.6 Jogging

During PC operation, the motor actuators are jogged using the GUI panel arrow keys. There are two jogging modes available, 'Single Step' and 'Continuous'. In 'Single Step' mode, the motor moves by the step size specified in the Step Size parameter. If the jog key is held down, single step jogging is repeated until the button is released - see Fig. 6.3.

In 'Continuous' mode, the motor actuator will accelerate and move at the jog velocity while the button is held down.



### Caution

If the actuator is driven into its end stops, the motor may stick and may not respond to subsequent motion demands. If this is the case, turn the adjustment knob of the actuator manually to move the device away from its end stop, then the motor should move normally.

## 5.7 Graphical Control Of Motor Positions (Point and Move)

The GUI panel display can be changed to a graphical display, showing the position of the motor channel(s). Moves to absolute positions can then be initiated by positioning the mouse within the display and clicking.

To change the panel view to graphical view, right click in the screen and select 'Graphical View'.



**Fig. 5.4 Stepper Driver K-Cube GUI Panel - Graphical View**

Consider the display shown above for an Stepper Driver K-Cube .

The right hand display shows the channel and motor unit parameters; i.e. controller unit type and serial number, associated stage and actuator type, minimum and maximum positions, current position, units per grid division and cursor position. All units are displayed in real world units, either millimetres or degrees.

### Note

For single channel units such as the Inertia Piezo Motor K-Cube, the Channel 2 parameters are greyed out.

The left hand display shows a circle, which represents the current position of the motor associated with the specified controller (absolute position data is displayed in the 'Chan Pos' field).

The vertical divisions relate to the travel of the stage/actuator associated with the Stepper Driver K-Cube (the stage/actuator is selected in the 'APT Config' utility). For example, the screen shot above shows the parameters for a 25mm travel ZFS25(B) motor actuator. The graph shows 10 divisions in the X axis, which relates to 2.5 mm of travel per division (25mm in total).

The graphical panel has two modes of operation, 'Jog' and 'Move', which are selected by clicking the buttons at the bottom right of the screen.

### **Move Mode**

When 'Move' is selected, the motors move to an absolute position which corresponds to the position of the cursor within the screen.

To specify a move:

- 1) Position the mouse within the window. For reference, the absolute motor position values associated with the mouse position is displayed in the 'Cursor Position' field.
- 2) Click the left hand mouse button to initiate the move.

### **Jog Mode**

When 'Jogging' mode is selected, the motors are jogged each time the left mouse button is clicked.

The Jog direction corresponds to the position of the cursor relative to the circle (current motor position), e.g. if the cursor is to the left of the circle the motor will jog left. The Jog Step size is that selected in the Settings panel - see Section 6.3.

### **Stop**

To stop the move at any time, click the 'Stop' button.

### **Returning to Panel View**

To return to panel view, right click in the graphical panel and select 'Panel View'.



## 5.8 Setting Move Sequences

This section explains how to set move sequences, allowing several positions to be visited without user intervention.

- 1) From the Motor GUI Panel, select 'Move Sequencer' tab to display the Move Sequencer window.

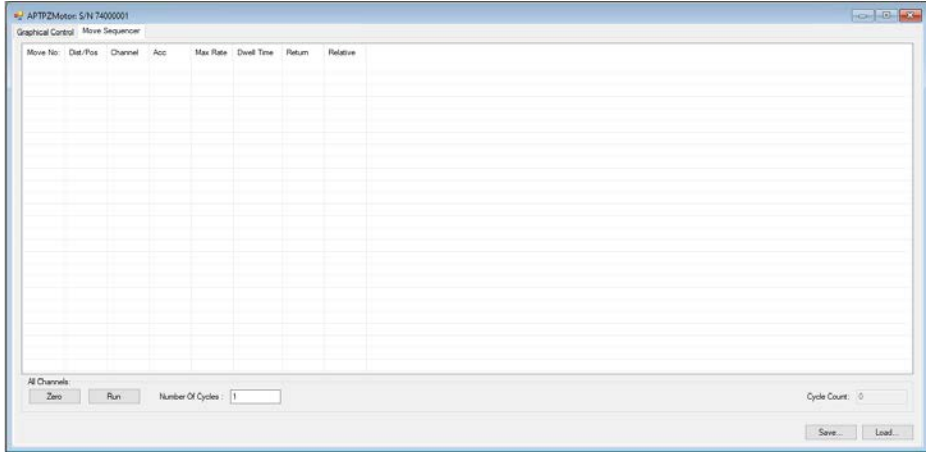

**Fig. 5.5 Move Sequencer Window**

- 2) Right click, in the move data field to display the pop up menu.

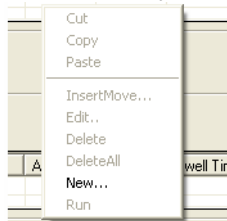

**Fig. 5.6 Move Sequencer Pop Up Menu**

3) Select 'New' to display the 'Move Editor' panel.

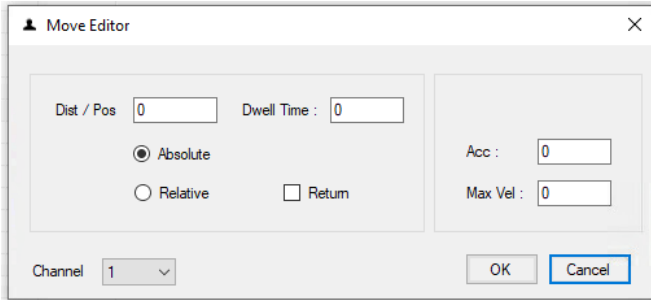

**Fig. 5.7 Move Editor Window**

Move data is entered/displayed as follows:

**Dist/Pos:** - the distance to move from the current position (if 'Relative' is selected) or the position to move to (if 'Absolute' is selected).

**Dwell Time:** - after the move is performed, the system can be set to wait for a specified time before performing the next move in the sequence. The Dwell time is the time to wait (in milliseconds).

**Return** - if checked, the system will move to the position specified in the Dist/Pos field, wait for the specified Dwell time, and then return to the original position.

4) **Acc: and Max Vel:** - the velocity profile parameters for the move.

**Note**

The 'Min Vel' parameter is not displayed because it is locked at zero and cannot be adjusted.

The motor accelerates at the rate set in the Acc field up to the speed set in the Max Vel field. As the destination approaches, the motor decelerates again to ensure that there is no overshoot of the position.



## 5.9 Creating a Simulated Configuration Using APT Config

The 'APT Config' utility can be used to set up simulated hardware configurations and place the APT Server into simulator mode. In this way it is possible to create any number and type of simulated (virtual) hardware units in order to emulate a set of real hardware. This is a particularly useful feature, designed as an aid learning how to use the APT software and as an aid to developing custom software applications 'offline'.

Any number of 'virtual' control units can be combined to emulate a collection of physical hardware units. For example, an application program can be written, then tested and debugged remotely, before running with the hardware.

To create a simulated configuration proceed as follows:

- 1) Run the APT Config utility - Start/All Programs/Thorlabs/APT/APT Config.
- 2) Click the 'Simulator Configuration' tab.

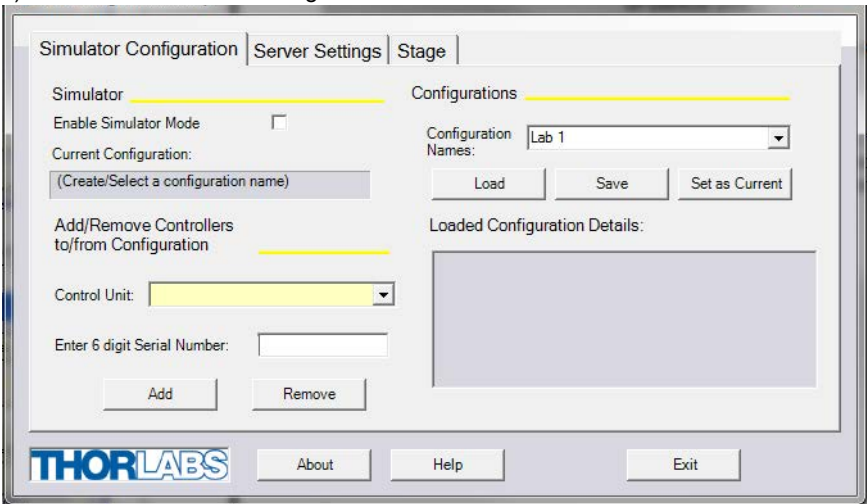
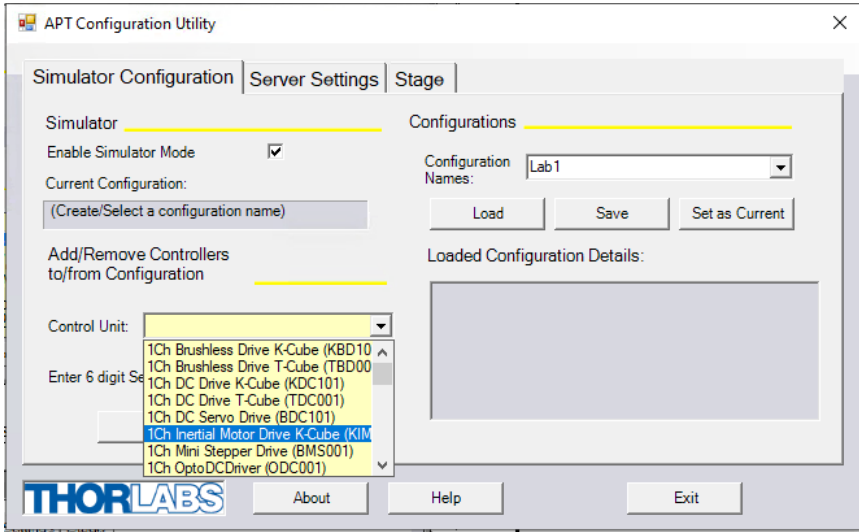

Fig. 5.11 APT Configuration Utility - Simulator Configuration Tab

- 3) Enter a suitable name, e.g. 'LAB1', in the Configuration Names field.

- 4) In the 'Simulator' field, check the 'Enable Simulator Mode' box. The name of the most recently used configuration file is displayed in the 'Current Configuration' window.



- 5) In the 'Control Unit' field, select '1Ch Inertial Motor Drive K-Cube (KIM)'.

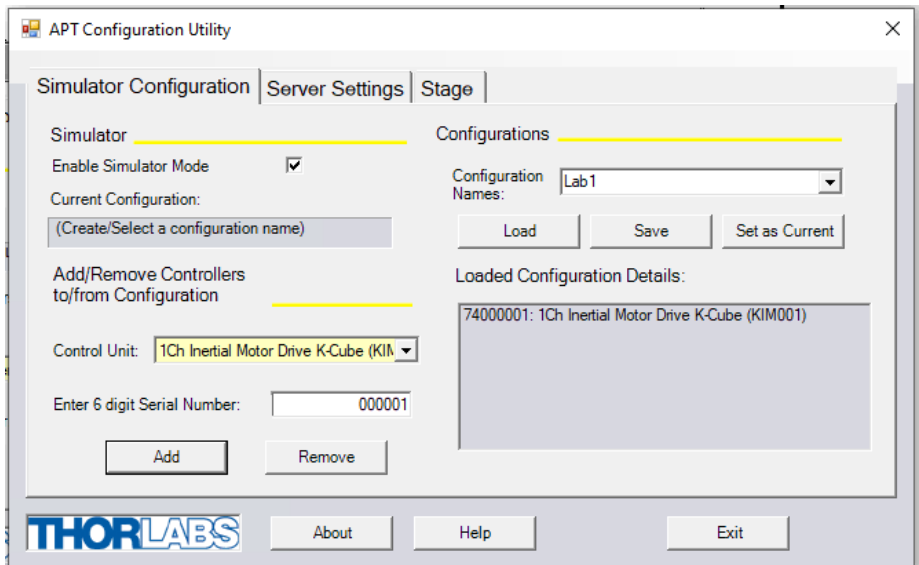

- 6) In the 'Enter 6 digit serial number' field, enter the serial number of your stepper drive unit.

**Note**

Each physical APT hardware unit is factory programmed with a unique 8 digit serial number. In order to simulate a set of 'real' hardware the Config utility allows an 8 digit serial number to be associated with each simulated unit. It is good practice when creating simulated configurations for software development purposes to use the same serial numbers as any real hardware units that will be used. Although serial numbers are 8 digits (as displayed in the 'Load Configuration Details' window), the first two digits are added automatically and identify the type of control unit.

The prefixed digits relating to the KIM001 Inertial Piezo Motor Driver K-Cube are:  
74xxxxxx - 1 Ch Inertial Motor Drive K-Cube

- 7) Click the 'Add' button.
- 8) Repeat items (1) to (7) as required. (A unit can be removed from the configuration by selecting it in the 'Loaded Configuration Details' window and clicking the 'Remove' button or by right clicking it and selecting the 'Remove' option from the pop up window).
- 9) Click 'Save'.
- 10) Click 'Set As Current' to use the configuration.

## Chapter 6 Software Reference

### 6.1 Introduction

This chapter gives an explanation of the parameters and settings accessed from the APT software running on a PC.

### 6.2 GUI Panel

The following screen shot shows the graphical user interface (GUI) displayed when accessing the Piezo Motor Driver K-Cube using the APTUser utility.



**Fig. 6.1 Piezo Motor Driver K-Cube Software GUI**

**Note.** The serial number of the Piezo Motor Driver K-Cube associated with the GUI panel, the APT server version number, and the version number (in brackets) of the embedded software running on the unit, are displayed in the top right hand corner. This information should always be provided when requesting customer support.

**Digital display** - Shows the position (drive pulses) of the motor associated with the unit. The motor must be 'zeroed' before the display will show a meaningful value, (i.e. the displayed position is relative to a physical datum).

**Jog** - used to increment or decrement the motor position. When the button is clicked, the motor is driven in the selected direction at the jog velocity one step per click. The step size and jog velocity parameters are set in the 'Settings' panel (see Section 6.3.).

**Zero** - Zeroes the position counter at the current motor position. Subsequent moves are then measured from the current position.

**Moving** - lit when the motor is in motion.

**Stop** - halts the movement of the motor.

**Settings display** - shows the following user specified settings:

*Driver* - the type of control unit associated with the GUI panel.

*Drive Voltage* - the maximum piezo drive voltage. Set in the range 85V to 125V.

*Drive Rate* - The velocity to move when a move command is initiated. It is specified in drive pulses/sec, in the range 1 to 2,000.

*Fwd Jog Step Size* - the size of step (ie. number of drive pulses) taken when the jog Forward signal is initiated.

*Rev Jog Step Size* - the size of step (ie. number of drive pulses) taken when the jog Backwards signal is initiated.

*Jog Rate* - The velocity to move when a jog command is initiated. It is specified in drive pulses/sec, in the range 1 to 2,000.

**Ident** - when this button is pressed, the text 'KIM001' on the top panel display of the associated hardware unit will flash for a short period.

**Active** - lit when the unit is operating normally and a motor is moving.

**Error** - lit when a fault condition occurs.

**Settings button** - Displays the 'Settings' panel, which allows the operating parameters to be entered for the motor drive - see Section 6.3.

### 6.3 Settings Panel

When the 'Settings' button on the GUI panel is clicked, the 'Settings' window is displayed. This panel allows motor operation parameters such as move/jog velocities to be modified. Note that all of these parameters have programmable equivalents accessible through the ActiveX methods and properties on this Control (refer to the *APTServer helpfile* for further details and to Section 1.3.4. for an overview of the APT ActiveX controls). The various parameters are described as follows.



### 6.3.1 Moves/Jogs Tab

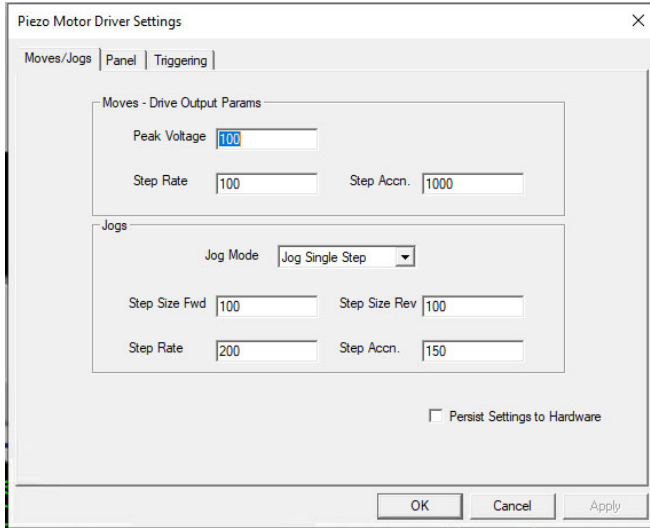

**Fig. 6.2 Piezo Motor Driver K-Cube - Move/Jog Settings**

Moves can be initiated via the GUI panel, either by using the jog buttons (see Section 5.6.) or by entering a position value after clicking on the position display box (see Section 5.4.), or by pressing the buttons on the unit.

#### Moves - Drive Output Params

These parameters define the speed and acceleration of moves initiated by clicking in the position display, or via the joystick when 'Go To Position' mode is selected.

*Peak Voltage* - the maximum piezo drive voltage. Set in the range 85V to 125V.

*Step Rate* - The piezo motor moves by ramping up the drive voltage to the value set in the *Peak Voltage* parameter and then dropping quickly to zero, then repeating (see Fig. 6.3). One cycle is termed a step. The Step Rate is the velocity to move when a command is initiated. It is specified in steps/sec, in the range 1 to 2,000.

*Step Accn* - The acceleration up to the step rate. It is specified in steps/sec/sec in the range 1 to 100,000.

#### Note

The step size is defined as the distance moved in one step or pulse. This distance can be adjusted up to about 30% by changing the piezo drive voltage. The actual step size achieved for a given drive voltage will be dependant on application.

## Jogs

These parameters define the speed and acceleration of moves by jog command, either from the joystick, GUI panel or via software.

**Jog Mode** - The way in which the motor moves when a jog command is received (i.e. front panel button pressed or GUI panel button clicked).

There are two jogging modes available, 'Single Step' and 'Continuous'. In 'Single Step' mode, the motor moves by the distance specified in the Step Size parameter. The jog key must be released and pressed again for jogging to be repeated - see Fig. 6.3. In 'Continuous' mode, the motor actuator will accelerate at the Step Accn value and move at the Step Rate while the button is held down..

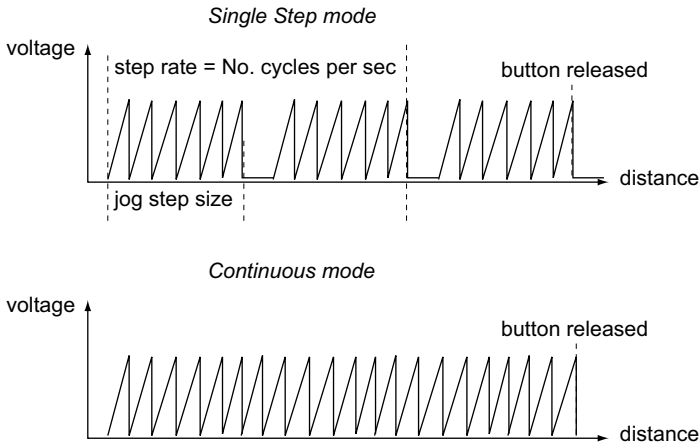

**Fig. 6.3 Jog Modes**

**Jog Step Size** - The distance to move when a jog command is initiated. The step size is specified by the 'number of steps' (or pulses)', in a jog step, in the range 1 to 2,000.

The optimum step size depends on several parameters including the resistive torque against which the actuator tip is pushing, the drive voltage, the step rate, active preload, variance in the frictional behaviour of assembly components, the direction of actuation and the condition of the actuator.

**Step Rate** - The velocity to move when a jog command is initiated. The step rate is specified in pulses per second, in the range 1 to 2,000.

**Step Accn** - The acceleration up to the step rate. It is specified in pulses/sec/sec in the range 1 to 100,000.

**Persist Settings to Hardware** - Many of the parameters that can be set for the Inertial Driver K-Cube can be stored (persisted) within the unit itself, such that when the unit is next powered up these settings are applied automatically. This is particularly important when the driver is being used manually in the absence of a PC and USB link. The Move and Jogging parameters described previously are good examples of

settings that can be altered and then persisted in the driver for use in absence of a PC. To save the settings to hardware, check the 'Persist Settings to Hardware' checkbox before clicking the 'OK button.



### Caution

The current settings are always saved to the unit (persisted) when the unit is powered down.

## 6.3.2 Panel Tab

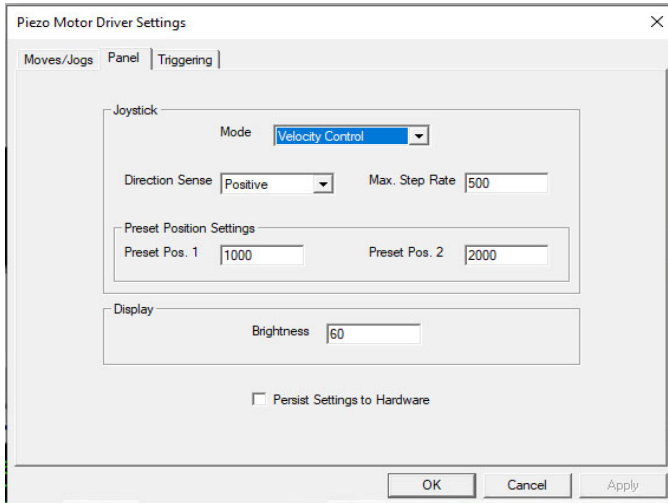

**Fig. 6.4 Piezo Motor Driver K-Cube - Panel Settings**

### Joystick Settings

The joystick is sprung such that when released it returns to its central position. In this central position the motor is stationary. As the joystick is moved away from the center, the motor begins to move; the speed of this movement increases as the deflection is increased. Bidirectional control of motor moves is possible by moving the joystick in both directions.

#### Mode

*Velocity Control* - Deflecting the joystick starts a move with the velocity proportional to the deflection. The maximum velocity (i.e. velocity corresponding to the full deflection of the joystick wheel) is set in the *Max Step Rate* parameter.

*Jogging* - Deflecting the joystick initiates a jog move, using the parameters specified by the Move/Jogs tab. The joystick must be released before another jog move can be initiated.

*Go To Position* - Deflecting the wheel starts a move from the current position to one of the two predefined "teach" positions. The teach positions are specified in

the *Preset Pos. 1* and *Preset Pos. 2* parameters, and are measured in number of steps from the home position. In this mode, move the joystick left (Ch1 and 3) or up (Ch 2 and 4) to go to position 1, and right or down to go to position 2.

**Note.** The motor can be zeroed by clicking the 'Zero' button on the GUI panel. Doing this will zero the position counter, and subsequent moves will be measured from the position the motor was at when the counter was zeroed.

#### *Direction Sense*

The direction of a move initiated by the joystick is specified as follows:

Disabled - The joystick is disabled to remove any unwanted motion due to accidental movement of the wheel.

Direction Sense Positive - Upwards (CH2 and CH4) and left (CH1 and CH3) movement of the joystick results in a positive motion (i.e. increased position count).

**Note.** The following option applies only when the Mode is set to Velocity Control. If set to Position Jogging or Go to Position Mode, the following option is ignored.

Direction Sense Negative - Upwards (CH2 and CH4) and left (CH1 and CH3) movement of the joystick results in a negative motion (i.e. decreased position count).

#### *Maximum Step Rate*

This parameter specifies the maximum velocity (step rate) used when moves are instigated via the joystick, in the range 1 to 1,000 steps per second.

#### *Display Brightness*

In certain applications, it may be necessary to adjust the brightness of the LCD display on the top of the unit. The brightness is set in the *Active Level* parameter, as a value from 0 (Off) to 100 (brightest). The display can be turned off completely by entering a setting of zero, however, pressing the MENU button on the top panel will temporarily illuminate the display at its lowest brightness setting to allow adjustments. When the display returns to its default position display mode, it will turn off again.

#### **Persist Settings to Hardware**

Many of the parameters that can be set for the Piezo Driver K-Cube can be stored (persisted) within the unit itself, such that when the unit is next powered up these settings are applied automatically. This is particularly important when the driver is being used manually in the absence of a PC and USB link. The joystick settings described above are good examples of settings that can be altered and then persisted

in the driver for use in absence of a PC. To save the settings to hardware, check the 'Persist Settings to Hardware' checkbox before clicking the 'OK button.



### Caution

The 'Persist Settings' functionality is provided to simplify use of the unit in the absence of a PC. When the unit is connected to a PC and is operated via APTUser, the default APTServer settings will be loaded at boot up, even if the 'Persist Settings' option has been checked.

### 6.3.3 Triggering Tab

Piezo Motor Driver Settings

Moves/Jogs | Panel | Triggering

Trigger Settings

Trig 1 Mode	Disabled	Trig 2 Mode	Disabled		
Trig. 1 Polarity	Active is High	Trig. 2 Polarity	Active is High		
Start Pos. Fwd	1000	Pos. Interval Fwd	100	Num. Pulses	50
Start Pos. Rev	6000	Pos. Interval Rev	100	Num. Pulses	50
Trig Pulse Width (us)	125	Num. of Move Cycles	10		
Relative Move Dist.	1000	Absolute Move Pos.	1000		

Persist Settings to Hardware

OK Cancel Apply

Fig. 6.5 Triggering Settings

### Triggering Introduction

The K-Cube piezo motor controllers have two bidirectional trigger ports (IO1 and IO2) that can be used to read an external logic signal or output a logic level to control external equipment. Either of them can be independently configured as an input or an output and the active logic state can be selected High or Low to suit the requirements of the application. Electrically the ports output 5 Volt logic signals and are designed to be driven from a 5 Volt logic.

When the port is used in the input mode, the logic levels are TTL compatible, i.e. a voltage level less than 0.8 Volt will be recognized as a logic LOW and a level greater than 2.4 Volt as a logic HIGH. The input contains a weak pull-up, so the state of the input with nothing connected will default to a logic HIGH. The weak pull-up feature allows a passive device, such as a mechanical switch to be connected directly to the input.

When the port is used as an output it provides a push-pull drive of 5 Volts, with the maximum current limited to approximately 8 mA. The current limit prevents damage

when the output is accidentally shorted to ground or driven to the opposite logic state by external circuitry.

Warning: do not drive the IO ports from any voltage source that can produce an output in excess of the normal 0 to 5 Volt logic level range. In any case the voltage at the TRIG ports must be limited to -0.25 to +5.25 Volts.

*Trig Mode* - The trigger functionality assigned to the associated trigger output as described below.

#### Input Trigger Modes

When configured as an input, the TRIG ports can be used as a general purpose digital input, or for triggering a relative, absolute or home move. When used for triggering a move, the port is edge sensitive. In other words, it has to see a transition from the inactive to the active logic state (Low->High or High->Low) for the trigger input to be recognized. For the same reason, a sustained logic level will not trigger repeated moves. The trigger input has to return to its inactive state first in order to start the next trigger. The mode is set in the *Trig 1 Mode* and *Trig 2 Mode* parameters as follows:

*Disabled* - The trigger IO is disabled

*Digital Input* - General purpose logic input (read through status bits using the associated server message).

*Trig In Rel. Move* - Input trigger for relative move. On receipt of the trigger, the motor will move by the number of position steps entered in the *Trigger Input Options - Relative Move Step* parameter.

*Trig In Abs. Move* - Input trigger for absolute move. On receipt of the trigger, the motor will move to the position entered in the *Trigger Input Options - Absolute Move Position* parameter.

*Trig In Zero Pos. Count* - Input trigger for Encoder Count Reset. On receipt of the trigger, the counter will reset and all subsequent moves will be measured from the current position.

When the trigger mode is selected to *Trig In Rel Move* or *Trig In Abs Move*, the relative distance or absolute position to move, can be entered in the *Relative Move Dist* and *Absolute Move Pos.* parameters.

---

## Output Trigger Modes

When the *Trig 1 Mode* and *Trig 2 Mode* parameters are configured as outputs, the TRIG ports can be used as a general purpose digital output, or to indicate motion status or to produce a trigger pulse at configurable positions as follows:

*Digital Output* - General purpose logic output (set using the appropriate server message).

*Trig Out In Motion* - Trigger output active (level) when motor 'in motion'. The output trigger goes high (5V) or low (0V) (as set in the Trig 1. Polarity and Trig. 2 Polarity parameters) when the stage is in motion.

*Trig Out Max Vel* - Trigger output active (level) when motor at 'max velocity'. The max velocity limit that generates the trigger is dependent on the type of move being performed, e.g. jog move, joystick move etc.

### Note

The following output modes can be set to only one trigger at a time. If an attempt is made to assign one of these modes to both trigger outputs, an error message will be generated.

*Trig Out Pos. Steps Fwd* - Trigger output active (pulsed) at pre-defined positions moving forward. Only one Trigger port at a time can be set to this mode. See Trigger Out Position Steps for further details.

*Trig Out Pos. Steps Rev* - Trigger output active (pulsed) at pre-defined positions moving backwards. Only one Trigger port at a time can be set to this mode. See Trigger Out Position Steps for further details.

*Trig Out Pos. Steps Both* - Trigger output active (pulsed) at pre-defined positions moving forwards and backward. Only one Trigger port at a time can be set to this mode. See Trigger Out Position Steps for further details.

## Trigger Out Position Steps

### Note

If the trigger mode is not set to one of the three position modes described previously, then the following parameters are not applicable and will be locked.

In the three *Pos. Steps* modes described above, the controller outputs a configurable number of pulses (set in the *Num. Pulses Fwd* and *Num. Pulses Rev* parameters), of configurable width (*Trig Pulse Width*), when the actual position of the stage matches the position values configured as the Start Position and Position Interval (*Start Pos. Fwd/Start Pos. Rev.* and *Pos Interval Fwd/Pos Interval Rev*). These modes allow external equipment to be triggered at exact position values.

Using the last three modes above, position triggering can be configured to be unidirectional (*Trig Out Pos. Steps Fwd* or *Trig Out Pos. Steps Rev*) or bidirectional (*Trig Out Pos. Steps Both*). In bidirectional mode the forward and reverse pulse sequences can be configured separately. A cycle count setting (*Num. of Move Cycles*) allows the uni- or bidirectional position triggering sequence to be repeated a number of times.

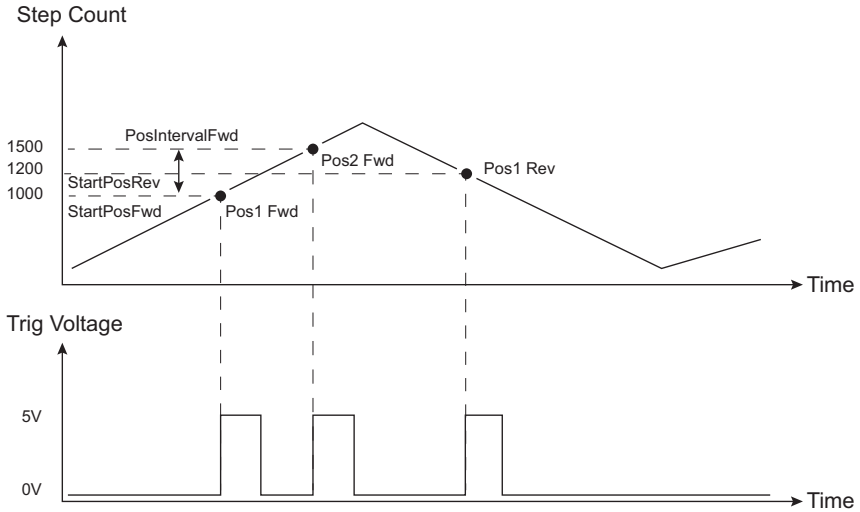

**Fig. 6.6 Position Steps Triggering**

#### Note

In the *Trig Out Pos. Steps Fwd* mode, the *StartPos. Fwd* value must be reached in the forward direction for the subsequent trigger sequence to be performed correctly. If *StartPos. Fwd* is reached in the reverse direction, the initial trigger will still be activated, but any subsequent sequence could be corrupted. Similarly, *StartPosRev* must be reached in reverse direction for the sequence to work correctly.

Example for a move from 0 to 2000 steps and back.

In forward direction: The first trigger pulse occurs at 1000 steps (*StartPosFwd*), the next trigger pulse occurs after another 500 steps (*PosIntervalFwd*), the stage then moves to 2000 steps.

In reverse direction: The next trigger occurs when the stage gets to 1200 steps.

Note that position triggering can only be used on one TRIG port at a time.

#### Trig Polarity

The polarity of the trigger pulse is specified in the *Trig. 1 Polarity* and *Trig 2 Polarity* parameters as follows:

*Active is High* - The active state of the trigger port is logic HIGH 5V (trigger input and output on a rising edge).

*Active is Low* - The active state of the trigger port is logic LOW 0V (trigger input and output on a falling edge).



## Appendix A Preventive Maintenance



### **Warning: Risk of Electrical Shock**

The equipment contains no user servicable parts. There is a risk of electrical shock if the equipment is operated with the covers removed. Only personnel authorized by Thorlabs Ltd and trained in the maintenance of this equipment should remove its covers or attempt any repairs or adjustments. Maintenance is limited to safety testing and cleaning as described in the following sections.

### **A.1 Safety Testing**

PAT testing in accordance with local regulations, should be performed on a regular basis, (typically annually for an instrument in daily use).

### **A.2 Cleaning**



#### **Caution**

Disconnect the power supply before cleaning the unit.

Never allow water to get inside the case.

Do not saturate the unit.

Do not use any type of abrasive pad, scouring powder or solvent, e.g. alcohol or benzene.

The fascia may be cleaned with a soft cloth, lightly dampened with water or a mild detergent.

## Appendix B Specifications and Associated Parts

### B.1 Specifications

Parameter	Value
<b>Piezoelectric Output (SMC)</b>	
Voltage Output	85 to 125 V DC
<b>External Input (SMA EXT IN)</b>	
Input Type	Single Ended, Analog
Input Voltage	-10 to 10 V $\pm 2\%$ -10 V gives nominally 2kHz pulses backwards 10 V gives nominally 2 kHz pulses forwards 0 V gives zero movement
Output Pulses	Frequency: 1 Hz to 2 kHz Voltage: Peak 85 to 125 V Adjustable
<b>Operating Display</b>	128 x 32 LCD Mono
<b>I/O 1 and I/O 2 Connectors</b>	TTL Input, TTL Output, 5V Level
<b>Wheel</b>	Spring-loaded, Center return Velocity Control, Menu Control in Setup Mode
<b>ENCODER Connector</b>	6 Pin HiRose For Future Use
<b>USB Connector</b>	The USB 3.0 (left hand side of the connector is compatible with a USB 2.0 Micro B) Communication speed USB 1.1
<b>Input Power Requirements</b>	
Voltage	15 VDC
Current	1 A
<b>General Data</b>	
Operating Temperature Range	5 ° to 40 °C
Housing Dimensions Excluding Baseplate (W x D x H)	60 mm x 60 mm x 47 mm (2.36" x 2.36" x 1.85")
Weight:	200 g

## B.2 Associated Products

<b>Product Name</b>	<b>Part Number</b>
Piezo Inertia Motor Actuator, 13 mm Travel	PIA13
Piezo Inertia Motor Actuator, 25 mm Travel	PIA25
Piezo Inertia Motor Actuator, 50 mm Travel,	PIA50
Piezo Inertia Motor Actuator, 10 mm Travel, Kinematic Mounting	PIAK10
K-Cube Controller USB Hub	KCH301 and KCH601
Single Way Power Supply	KPS101
20 mm Linear Stage with Piezoelectric Inertia Drive	PD1

# Appendix C Piezo Operation - Background

## C.1 Piezoelectric Controller

### C.1.1 The Piezoelectric Effect

Piezoelectricity is the effect whereby certain types of crystal expand reversibly when subjected to an electric field.

Although the amount of expansion is usually very small (corresponding to less than 1% strain in the material) it can be controlled extremely finely by varying the strength of the electric field. Piezoelectric materials therefore form the basis of very high precision actuators. The resolution of these actuators is effectively only limited by the noise and stability of the drive electronics. Moreover, the force generated by the expanding piezo is very large, typically hundreds of newtons.

Perhaps the most useful property of these actuators is their ability to produce oscillating motion at considerable frequencies, usually limited by the mechanical system driven rather than by the piezo actuator itself. This ability is used to advantage in the NanoTrak control system, for example.

The electric field gradient needed to produce a useful amount of expansion is quite large. Thus to avoid excessive drive voltages, the actuator is constructed as a stack, consisting of lamina of active material sandwiched among electrodes – see Fig. C.1. In this way, the distance from positive to negative electrodes is very small. A large field gradient can therefore be obtained with a modest drive voltage (75 V in the case of Thorlabs actuators).

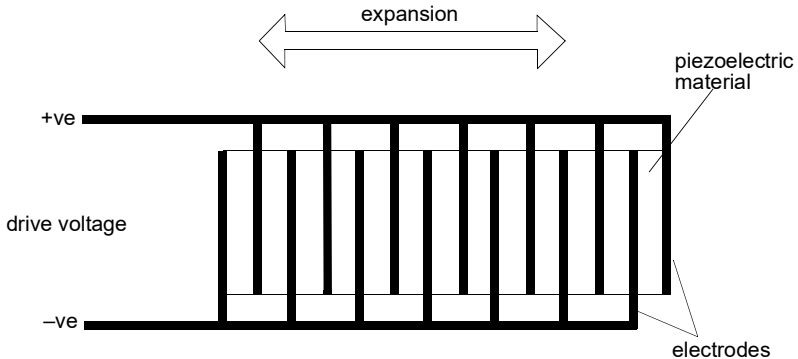
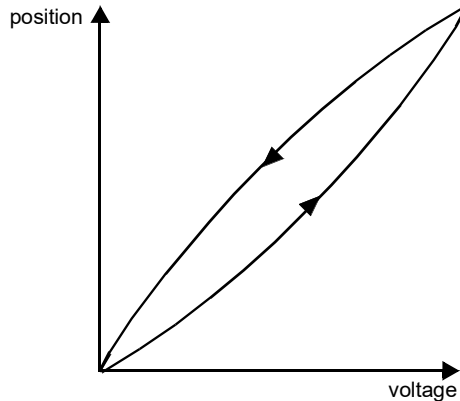

Fig. C.1 Piezo-electric actuator schematic diagram

### C.1.2 Hysteresis

Despite the very high resolution of piezoelectric actuators, an inherent problem is the significant amount of hysteresis they exhibit, (i.e., the tendency of the actuator to reach a final position that lags behind the demand position).

If a cyclic voltage is applied to the actuator the positions reached on the upward sweep are smaller than those achieved on the downward sweep. If position is plotted against voltage, the graph describes a hysteresis loop – see Fig. C.2.



**Fig. C.2 Piezo-electric hysteresis**

### C.1.3 Position Sensing and Feedback Control

Hysteresis can be eliminated by using a position sensor and feedback loop, i.e., the sensor measures the position, the circuit subtracts the measured position from the demand position to get the error, and a proportional-integral feedback loop adjusts the voltage to the actuator until the error is virtually zero.

Some Thorlabs nanopositioning actuators have position sensing, others do not. The Piezoelectric control module allows both types to be controlled.

To control an actuator with position sensing, the Piezoelectric control module should be set to closed-loop mode. To control an actuator without position sensing, the Piezoelectric Control module should be set to open-loop mode.

#### **Note**

An actuator with position sensing can also be driven in open-loop mode if desired, since the feedback part of the circuit can be switched off. An advantage of open-loop mode is the greater bandwidth of the system.

Block diagrams for both modes of operation are shown in Fig. C.1.

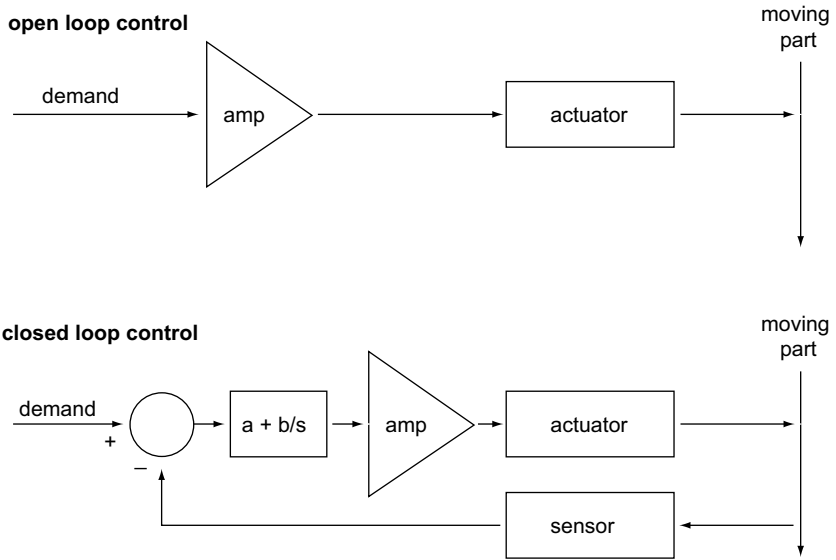

**Fig. C.3 Open loop and closed loop control**

The result of using closed-loop control is a linear relationship between demand (voltage) and measured position – see Fig. C.4, in contrast to open loop control – see Fig. C.2.

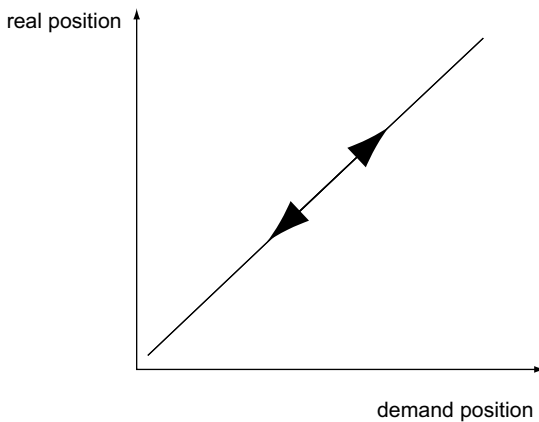

**Fig. C.4 Closed loop response**

## Appendix D Regulatory

### D.1 Declarations Of Conformity

4.1.1 For Customers in Europe  
See Section D.2.

#### 4.1.2 For Customers In The USA

This equipment has been tested and found to comply with the limits for a Class A digital device, pursuant to part 15 of the FCC rules. These limits are designed to provide reasonable protection against harmful interference when the equipment is operated in a commercial environment. This equipment generates, uses and can radiate radio frequency energy and, if not installed and used in accordance with the instruction manual, may cause harmful interference to radio communications. Operation of this equipment in a residential area is likely to cause harmful interference in which case the user will be required to correct the interference at his own expense. Changes or modifications not expressly approved by the company could void the user's authority to operate the equipment.