

## UNIVERSAL ELECTRONIC DRIVER UED-KA

for solenoid operated proportional valves

### 1 DESCRIPTION

The driver controls one solenoid of a proportional valve. His construction permits an easy assembly directly on the ISO 4400 connection on the valve. By the use of two selectors it is possible to easily configure all the parameters without the need of special tools or programming devices.

A 3 digit led display shows all the necessary informations.

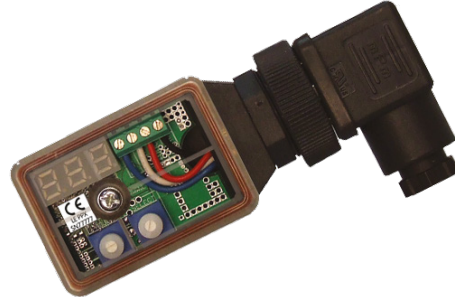

### 2 ORDERING CODE

(1)		(2)
UED	-	KA

### 3 SET UP PROCEDURE

- (1) At power up, the display will show either the output current signal or the input signal (Default display setting shows the output signal). The decimal point will be flashing.
- (2) Rotate SELECT to enter the set-up mode. Parameter abbreviation is indicated on the display
- (3) When you reach the setting you want to modify, rotate ADJUST up or down to the desired value.
- (4) To modify another setting, rotate SELECT again and repeat.
- (5) The Driver is fully functional during the set-up procedure with any adjustments effective immediately.
- (6) In order to write the new settings in the memory and return to normal mode of operation, rotate „SELECT“ until the display shows „SR“ and then rotate „ADJUST“ from 0 to 1 or wait for 100 seconds.
- (7) If you do not want to save the new settings you have just modified, you must disconnect the Driver from the power supply before the end of the 100 seconds to restore precious settings.
- (8) After saving parameters to memory, the decimal point will be flashing and the Driver display will be back showing either the output current signal or input signal depending on your „di“ selection.
- (9) To start over completely, you can restore the factory settings by rotating SELECT to rFP and then rotate ADJUST up past 10 for the display to reset (NOTE for Step 9: you may have to adjust your Input Signal Setting again if you reset to factory settings.)

### 4 TECHNICAL DATA

Operating voltage:	9-36 V DC
Maximum output current:	3,00 A
Input signal:	0-5 V; 0-10V; 4-20 mA
Maximum ramp time:	99,5 s
Linearity:	40-450 Hz
Operating Temperature:	-40 .. 75 °C
Protection grade:	IP 65*
Recommended cross section of wires:	0,5 .. 0,75 mm <sup>2</sup>
Mounting:	DIN 43650-A/ISO4400 solenoid and cable connector

\* A cable with a circular cross section and outside diameter of 4 .. 6 mm should be used for the electronics supply. Only in this way the declared IP protection can be assured.

### 5 KEY FEATURES

- Microcontroller design
- Independent adjustments (ramp up - ramp down)
- 3 digit led display
- Display and adjust actual values (current&voltage)
- Easy access to the menu setup
- Wide ramp time range
- Simple control with analog input, locally supplied reference voltage
- No heat sink required
- Electronic limiting circuit/short circuit proof
- Reverse polarity, command input protection
- Load can be connected and disconnected live

## 6 SETTING RANGES

Parameter	Description	Adjustable Range
Hi *	HIGH, Maximum Current Output	0,20 - 3,00 A
Lo *	LOW, Minimum Current Output (see note 1)	0,00 - 2,99 A
rUP *	RAMP UP, Time for Output to increase from min to max	0,0 - 99,5 s
rdn *	RAMP DOWN, Time for Output to decrease from max to min	0,0 - 99,5 s
Cdb	COMMAND DEADBAND, Output disabled if command signal is less then deadband	0 - 5 %
dFr	DITHER FREQUENCY	40 - 450 Hz
in	INPUT SIGNAL SELECTION: 5 - Voltage signal 20 - Voltage signal 420 - Current signal	0 - 5 V 0 - 10 V 4 - 20 mA
di	DISPLAYED SIGNAL FOR TROUBLESHOOTING: 0 - Command signal [V] or [mA] 1 - Output signal [A] **Flashing decimal point is an indicator for present display mode** - Fast flashing decimal point, several flashes per second indicates di=0 - Slow flashing decimal point, 1 per second indicates di=1 - No flashing decimal point or no decimal point indicates display in SETTING/ADJUST	
SA	SAVE SETTINGS	
rFP	RESET FACTORY PARAMETERS (see note 2)	
Err	ERROR DETECTION STATE, short circuit, reverse polarity protection and detection: 0 - Error 0 - No errors 1 - Error 1 - Overcurrent in driver likely due to short circuit in Solenoid 2 - Error 2 - Current exceeding 20 mA in 4-20 mA input mode	
CLr	CLEAR ERROR, clear driver or error state (see note 2)	
NOTE 1	When adjusting the HI and LO parameters, note the HI parameter value cannot be adjusted below the LO parameter value as well the LO parameter value cannot exceed the HI parameter value.	
NOTE 2	Adjust Parameter value up past 9 to operate this command setting	

## 7 INSTALLATION DIMENSIONS (mm)

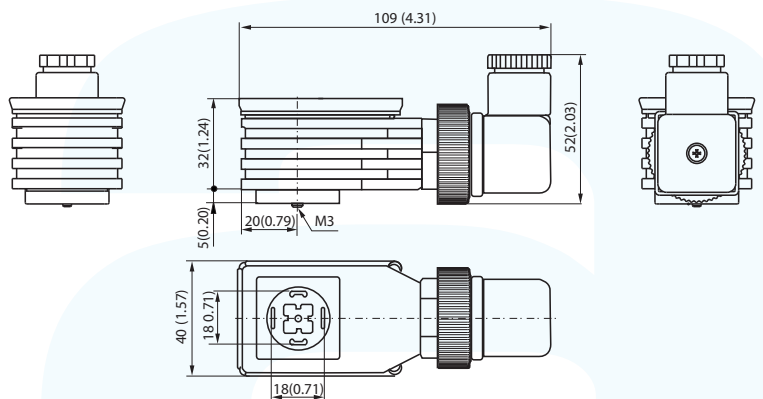
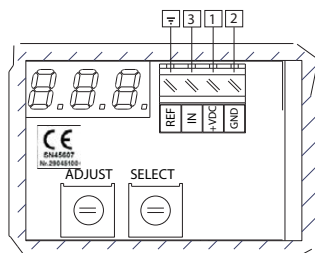
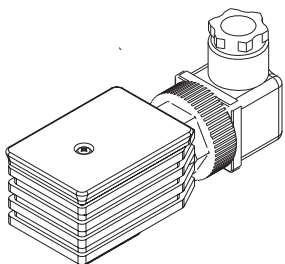

## 8 SCHEMATICS

1) EXTERNAL INPUT SIGNAL CONNECTION  
("in" set to "10")

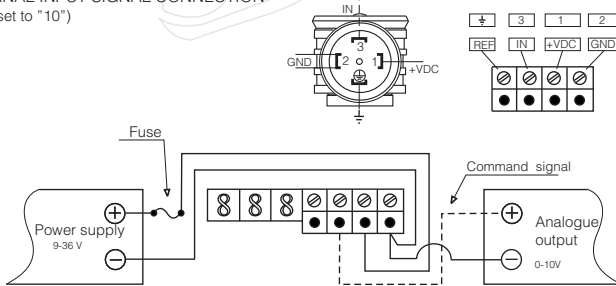

2) POTENTIOMETER CONNECTION  
("in" set to "5")

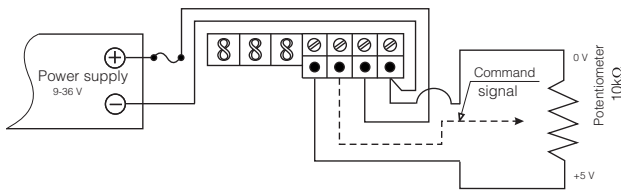

3) RAMP UP & DOWN ONLY OPERATION  
("in" set to "5")

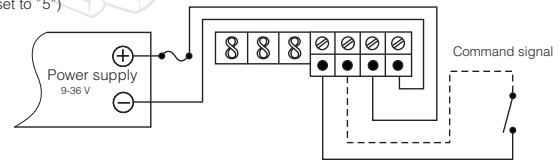

4) EXTERNAL INPUT SIGNAL CONNECTION 4-20 mA  
("in" set to "420")

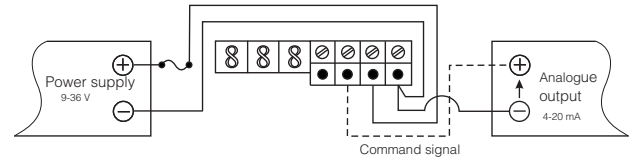

5) TWO WIRE TRANSMITTER INPUT CONNECTION 4-20 mA  
("in" set to "420")

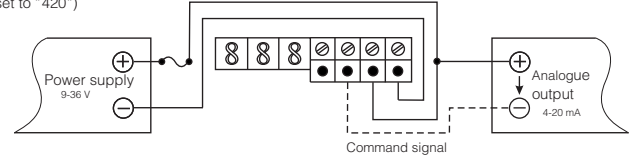

## 9 ADJUSTMENT

Adjustment of Maximum:  
(High) / parameter „Hi“  
Maximum Current output 0,20 - 3,00 A

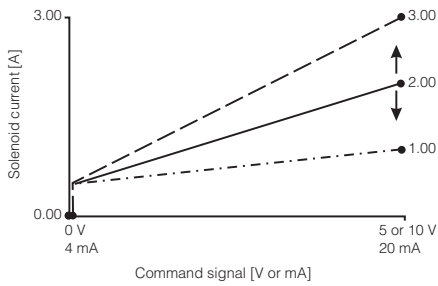

Adjustment of minimum  
(Low) / parameter „Lo“  
Maximum Current output 0,00 - 2,99 A

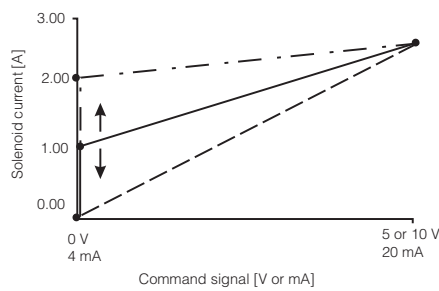

Adjustment Ramp  
(Ramp up) / parameter „rUP“  
Time for Output to Increase from min to max, 0 - 99,5 s

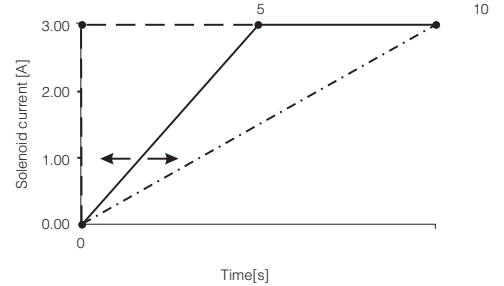

Adjustment Ramp  
(Ramp down) / parameter „rDn“  
Time for Output to Decrease from max to min 0 - 99,5 s

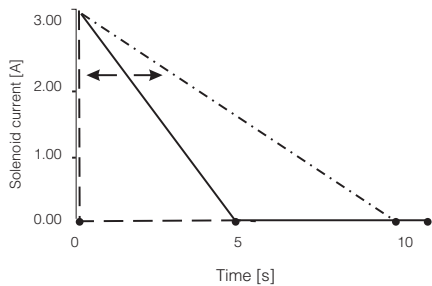

Adjustment (Command deadband) / parameter „Cdb“  
Output disabled if command signal less than deadband  
0 - 5 % of the maximum Command signal

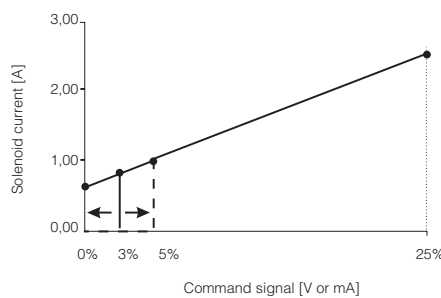

DITHER FREQUENCY / parameter „dFr“  
Frequency settable in a range of 40 - 450 Hz

