

Manufacturer: **Hatteland Technology AS**  
 Product: **HATTELAND® SeaHawk - IP Camera**  
 Typenumber: **HT FBVF xA-X1**  
 where x = housing material/color  
 Description: **SeaHawk Bullet Varifocal IP Camera**

Last Revised: **08 Dec 2020**  
 Revision#: **02**

## SeaHawk Bullet Varifocal - IP Camera

### Description:

HATTELAND® SeaHawk IP Camera from Hatteland Technology is the perfect IP camera solution with full HD resolution at 30fps. The camera housing is constructed in sturdy POM material.

2.5x OpticalZoom, PoE - Power over Ethernet, Stream compression H265/H264, Motion Detection, No sharp edges, Designed to meet IEC60945 and IP66/IP67, Mounting: Ceiling/Wall, Day/night mode

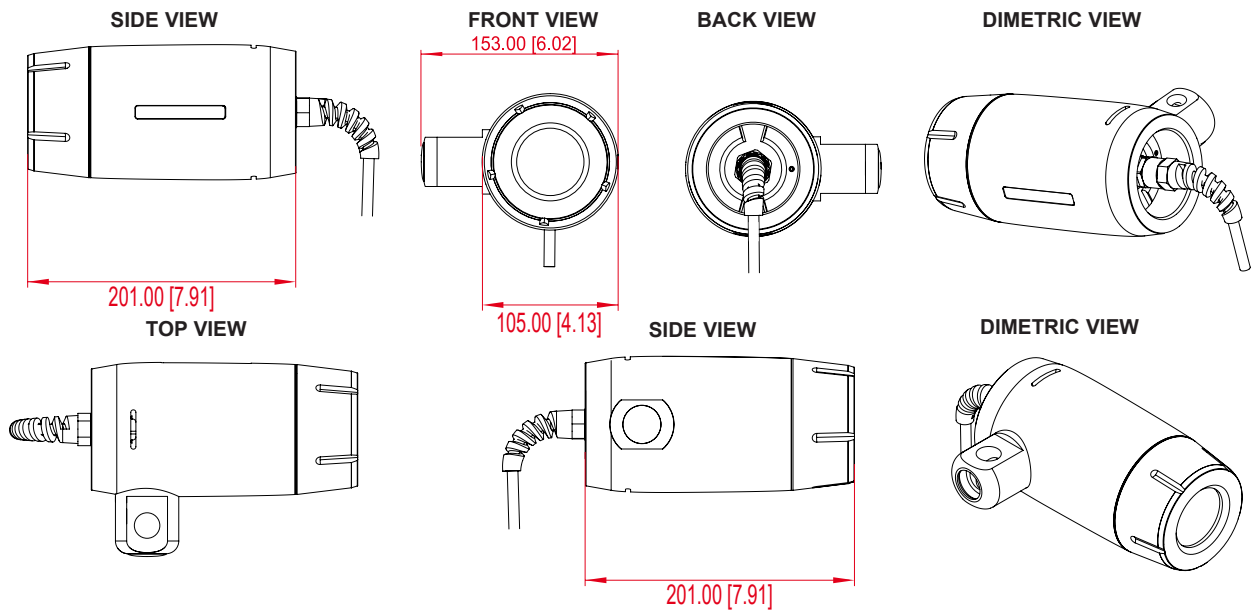

With HT MB11-AA Note: Variant of model illustration shown below

**DIMETRIC VIEW**  
Ceiling mount

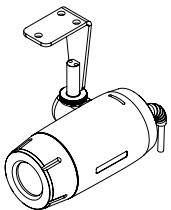

**TOP VIEW**  
Ceiling mount

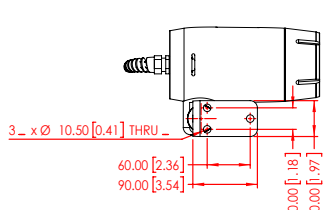

**DIMETRIC VIEW**  
Wall Mount

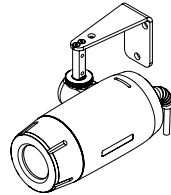

**TOP VIEW**  
Wall Mount

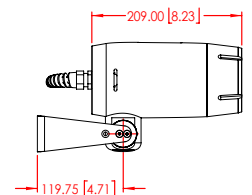

**FRONT VIEW**  
Ceiling mount

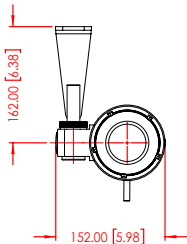

**SIDE VIEW**  
Ceiling mount

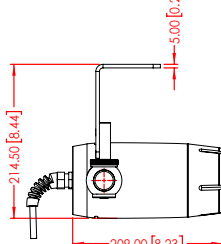

**BACK VIEW**  
Wall Mount

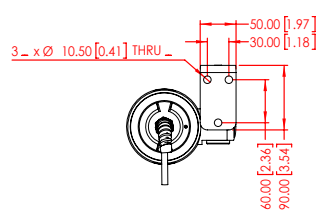

**SIDE VIEW**  
Wall Mount

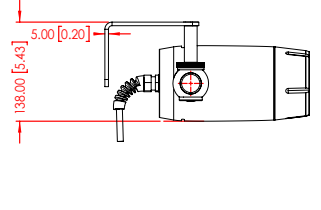

**Max Pan and Tilt angles**

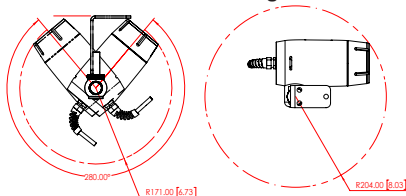

**Max Pan and Tilt angles**

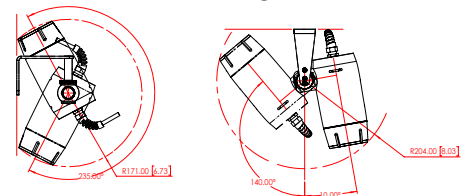

Dimensions might be shown with or without decimals and indicated as mm [inches]. Tolerance on drawings is +/- 1mm. For accurate measurements, check relevant DWG file.

## TECHNICAL DESCRIPTION

### Technical Specifications:

• Image Sensor	1/2.8" Progressive Scan CMOS
• Lens Type	Auto DC Iris, Varifocal lens, IR cut filter
• Zoom	2.5X Optical Zoom
• Focal Length	f=2.8mm ~ 12mm
• Maximum Aperture Ratio	F1.4
• Angle of View	Wide: H: 103°, V: 74.4° Tele: H: 30.8°, V: 23.3°
• Electronic Shutter Speed	1 ~ 1/30 sec (B/W), 1/24 ~ 1/1000 sec (color)
• Flip Mode	Horizontal, Vertical
• Image Enhancement	AF, AWB, AE, NR, TDN, DSS, BLC, GAMMA, DPC, DEFOG, WDR

### Video Specifications:

• Compression	H265 / H264 / MJPEG
• Frame Rate	Max 30fps @ 1920 x 1080
• Bitrate	Primary: 32Kbps ~ 16Mbps. Secondary: 32Kbps ~ 4Mbps
• Resolutions	352 x 240 ~ 1920 x 1080
• Streaming	Primary: H265 / H264, Secondary: H265 / H264 / MJPEG
• Burn-in OSD	Multi-lingual

### Network Specifications:

• Interface	1 x Ethernet 10/100base-T (RJ-45)
• Protocol	IPv4/v6, TCP, UDP, IGMP (MULTICAST), ICMP, DHCP, HTTP, HTTPS, RTP, RTSP, FTP, SNMP, UPnP, WS-Discovery, Zero-configuration, NTP, DDNS
• Security	Password protection, IP address filtering, HTTPS encryption
• API	ONVIF, PSIA, MPEG-TS

### Event and General Specifications:

• Event Sources	Motion, Sensor Input, Client disconnection
• Event Actions	Notification (E-mail), FTP, Alarm control, Recording
• Housing	POM (Polyoxymetylen), RAL 5012 (ring)
• Certification	Designed to meet IEC60945, IP66/IP67
• Power Supply	PoE: 802.3af via RJ-45
• Power Consumption	12W (max)
• Operating Temperature	-40°C to +65°C
• Storage Temperature	TBD

### Physical Specifications:

• Dimensions	W:153.00 [6.02"] x H:105.00 [4.13"] x D:201.00 [7.91"] mm [inch]
• Weight	1.9kg / 4.19lbs
• Pigtail Cable	2.5 [8.20] m [ft], Cat5e STP, RJ-45 terminated

### Contents of Package:

• 1 x HT FBVF xA-X1 (Camera)
• 1 x HT MB1x-AA (Ceiling/Wall Bracket)
• 1 x IND105044-1 (Quick Start Guide)
• 1 x LD-001 (IP67 coupler for patch cable, 2 x RJ-45 female-to-female)
• 1 x SVN_Allen_3mm (3mm allen/hex Key)

### Available Models:

• HT FBVF AA-X1	SeaHawk FixedBullet Varifocal POM Black ,RAL TBD
• HT FBVF WA-X1	SeaHawk FixedBullet Varifocal ALU. White RAL9010

### Accessories:

• HT MB11-AA	SeaHawk Bullet Ceiling/Wall Bracket ALU. Black RAL9005*
• HT MB12-AA	SeaHawk Bullet Ceiling/Wall Bracket White RAL9010**
• HT WB11-AA	SeaHawk Bullet Wall Bracket ALU. Black RAL9005***
• HT WB12-AA	SeaHawk Bullet Wall Bracket ALU. White RAL9010***
• HT CB11-AA	SeaHawk Bullet Ceiling Bracket ALU. Black RAL9005***
• HT CB12-AA	SeaHawk Bullet Ceiling Bracket ALU. White RAL9010***
• LD-001	IP67 coupler for patch cable, 2 x RJ-45 female-to-female*

\*Included with purchase of HT ZB2X AA-X1  
\*\*Included with purchase of HT ZB2X WA-X1  
\*\*\*Designed to meet IEC60945