

Spindle ball bearings (HY)* S 625 C

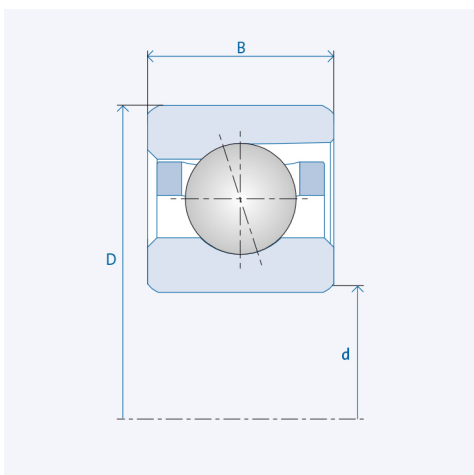

Precision class P4 / ABEC7

Components

Bearing designation:	(HY)* S 625 C
Bearing design:	S
Series / size:	625
Ball material:	Steel 100Cr6
Ball material HY :	Ceramic Si3N4
Cage:	TA (TXM available upon request)
Precision:	P4 (HG, UP, P2 upon request)
Main dimensions [d x D x B]:	5 x 16 x 5 mm

Technical data (Standard bearings)

Static load capacity C_0 :	710
Dynamic load capacity C:	1930
Speed limit n_{Fett} :	127500
Speed limit n_{Oj} :	170000

Technical data (Hybrid bearings)*

Static load capacity C_{0HY} :	500
Dynamic load capacity C_{HY} :	1930
Speed limit n_{Fett} :	159375
Speed limit n_{Oj} :	212500

Pre-tension

Light (L):	10 N
Axial rigidity (C_{ax}):	9 N/ μ m
Medium (M):	30 N
Axial rigidity (C_{ax}):	14 N/ μ m
Heavy (S):	60 N
Axial rigidity (C_{ax}):	21 N/ μ m
Spring preload (Ff):	50 N

The given speed limits apply to individual bearings with spring preload. Correction factors must be considered for all properties which deviate from this.

* All ball bearings are also available as hybrid ball bearings (HY).