

Spindle ball bearings (HY)* SM 61903 C

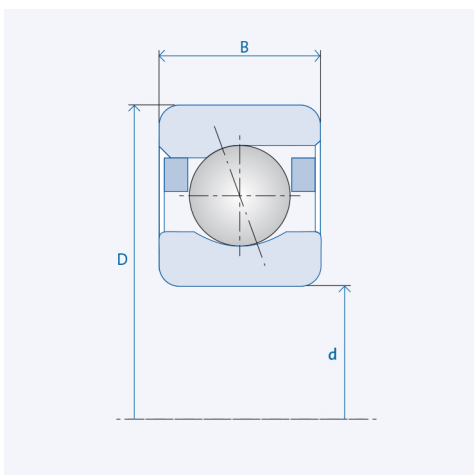

Precision class P4 / ABEC7

Components

Bearing designation:	(HY)* SM 61903 C
Bearing design:	SM
Series / size:	61903
Ball material:	Steel 100Cr6
Ball material HY :	Ceramic Si3N4
Cage:	TA (TXM available upon request)
Precision:	P4 (HG, UP, P2 upon request)
Main dimensions [d x D x B]:	17 x 30 x 7 mm

Technical data (Standard bearings)

Static load capacity C_0 :	1750
Dynamic load capacity C:	3750
Speed limit n_{Fett} :	63000
Speed limit n_{Oj} :	84000

Technical data (Hybrid bearings)*

Static load capacity C_{0HY} :	1230
Dynamic load capacity C_{HY} :	3750
Speed limit n_{Fett} :	78750
Speed limit n_{Oj} :	105000

Pre-tension

Light (L):	19 N
Axial rigidity (C_{ax}):	16 N/ μ m
Medium (M):	55 N
Axial rigidity (C_{ax}):	25 N/ μ m
Heavy (S):	110 N
Axial rigidity (C_{ax}):	34 N/ μ m
Spring preload (Ff):	115 N

The given speed limits apply to individual bearings with spring preload. Correction factors must be considered for all properties which deviate from this.

* All ball bearings are also available as hybrid ball bearings (HY).