

Type D Access Interlock

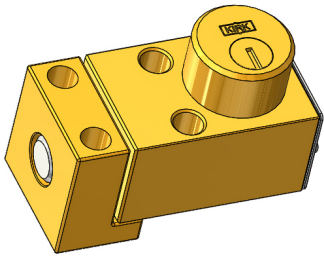

SD Series

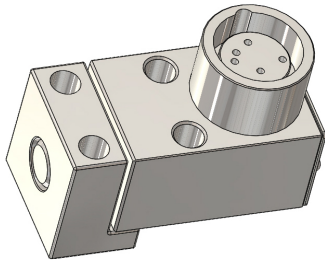

HD Series

KIRK Type D access interlocks provide a physical barrier to either partial or full body access points until risk of hazardous energy or moving equipment has been mitigated.

All Type D interlocks have two parts: a main body with one or more cylinders and a latch block. Proper alignment of both parts is crucial to the operation of a Type D interlock. When the main body is separated from the latch block, the lock bolt is retained in the withdrawn position by concealed latch pins; the key(s) is trapped in the lock whenever the two parts are separated. When the door the Type D is mounted on is closed, the key(s) can be turned to extend the lock bolt into the latch block, securing the door. Only extending the lock bolt, after properly closing the door, should allow release of the key(s).

An exception to this rule is a multiple cylinder Type D interlock which allows release of a “personnel” key when the door is opened. The personnel key can be put in the pocket of the maintenance person ensuring that the door cannot be closed and locked while the released personnel key is on the person.

OPERATION

KIRK Type D interlocks are mechanically operated and suitable for access applications in which hazardous energy or moving equipment is present.

Type D key operated mechanical interlock

- 1 Key is released, latch block is engaged, ensuring access point is locked.

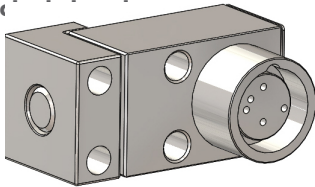

- 2 Insert and turn key, which will disengage latch block and trap key.

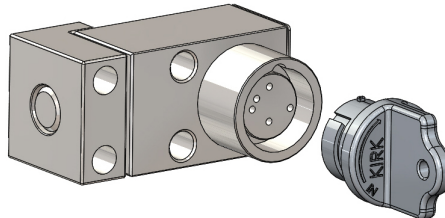

- 3 Latch block is disengaged, access point is open, and key is trapped.

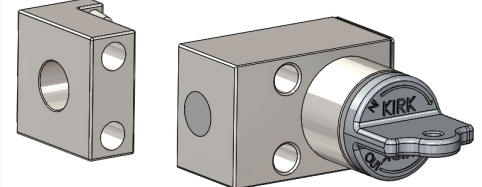

For HD multiple cylinder interlocks, all missing keys must be inserted and turned before any trapped keys can be released.

Type D Access Interlock



USAGE

KIRK Type D access interlocks should be used to allow safe access into potentially hazardous areas. KIRK Type D access interlocks can be used for partial or full body access points. For full body access, a multiple cylinder interlock is recommended to ensure a personnel key can be released to be kept on the person(s) performing maintenance.

 KIRK Type D access interlock should not be used to align the door, or be the latching means for holding the door in the closed position.

No hazardous substances were used in the manufacturing of the product. The product can be disposed of in standard waste receptacles.

INSTALLATION

The housing of the Type D should be mounted on the access door and the latch block should be mounted on the door frame aligned with the mounting location of the housing.

SD series (brass) interlocks are supplied with a key in each cylinder. These keys are needed during installation of the interlocks. SD series (brass) bolt interlocks with multiple cylinders require the insertion of all keys before the lock bolt can be extended or withdrawn. Do not try to force a multiple cylinder interlock that does not have the correct keys fully inserted in every cylinder!

HD series (stainless steel) interlocks are not sold with keys. Keys must be ordered separately and may be required during the installation process.

 For all interlock systems to maintain system integrity, additional keys must be removed from the system and destroyed or retained by a responsible person. There should only be enough keys to operate the interlock system sequentially. Kirk Key Interlock Company will not be responsible for extra keys left in the interlock system.

 All interlocks and interlock systems must be installed by a competent and qualified person who has read and understood these instructions. Please retain this document in your technical files.

MAINTENANCE

Kirk key interlocks should be periodically lubricated with a small amount of dry powder graphite. DO NOT use oil or grease of any type as these will collect dirt and impede the proper operation of the lock cylinder.

SD SERIES: Apply a small amount of graphite to the key and insert the key into the lock cylinder. Work the key in an out and turn the key several times in order to distribute the graphite inside the lock cylinder.

HD SERIES: Apply a small amount of graphite behind the inner turn shaft. Insert and turn the key a few times in order to distribute the graphite below the lock cylinder.

KIRK offers a Graphite Lubrication kit (part# GL-1) complete with instructions for use.

Protective covers for most products are also available as accessories. Covers can be utilized to protect the lock cylinders when located outdoors or in a demanding environment.

Type D Access Interlock



TECHNICAL DATA

Type D	SD Series	HD Series
Interlock Housing	Brass	Electropolised 316 SS
Cylinder Housing	Brass	Electropolised 316 SS
Plug/Inner Turn Shaft	Brass	Electropolised 316 SS
Key Material	Nickel-Silver	Electropolised 316 SS
Key Style	7-Pin Tumbler	Dowel Pin
Latch Block	Brass	Electropolised 316 SS
Type of Mounting	Main body is mounted to the moving door and the latch block is mounted to the door frame using suitable fasteners. Refer to drawing for details.	
Temperature Ratings	-65F to +250F	-65F to +700F
Weight	2.51 pounds	2.23 pounds

* Weight based on product with 1 cylinder, no key, accessories, or mounting hardware

APPLICATION

KIRK Type D interlocks are mechanically operated and suitable for access applications in which hazardous energy or moving equipment is present.

The interlock application scheme 33 from the KIRK scheme book is to prevent the opening of guard B when power is on.

Initial system status: Power is on. Guard B is locked closed and switch is in the closed position. Key A-1 is trapped in the bolt interlock on the switch.

To gain access and begin maintenance on moving equipment, open switch and turn key A-1 in bolt interlock on switch. Key A-1 is now free and switch is locked open. Insert Key A-1 into Type D L-C (locked closed) interlock on Guard B and turn and unlock. Guard B is now open and Key A-1 is now trapped in Type D.

If this is full body access and multiple cylinder Type D is recommended. This allows for Key A-2 to be released and held with the person performing maintenance.

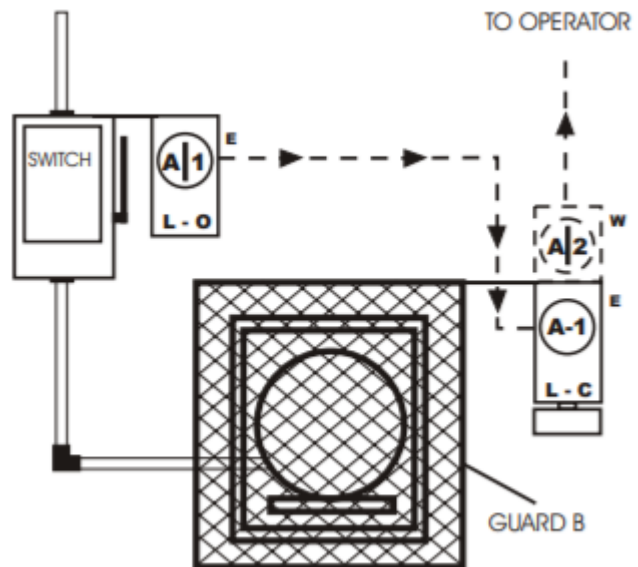

Type D Access Interlock



DRAWING

Dimensions: in inches

SD Series Type D

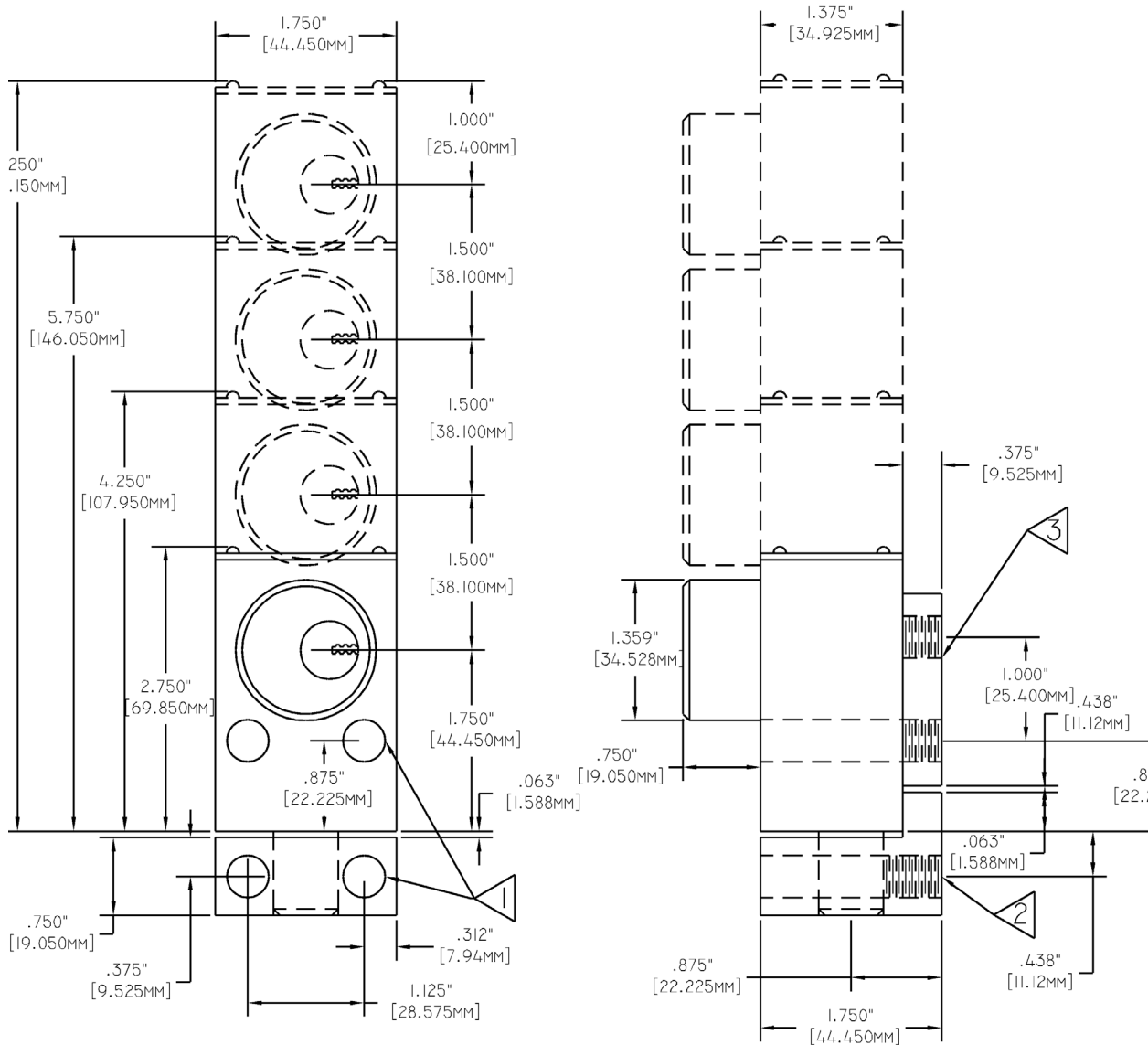

NOTES:

- 1) 0.4062" (10.32mm) holes for mounting bolts (4 holes).
- 2) 1/2"-13 thread tapped 1/2" from bottom (latch block only).
- 3) Optional adapter plate shown - see Data Sheet (3.3) for Adapter Plate details.

Caution: The Type D interlock should not be used to align the door, or to be the latching means for holding the door in the closed position.

Type D Access Interlock



DRAWING

Dimensions: in inches

SD Series Type D

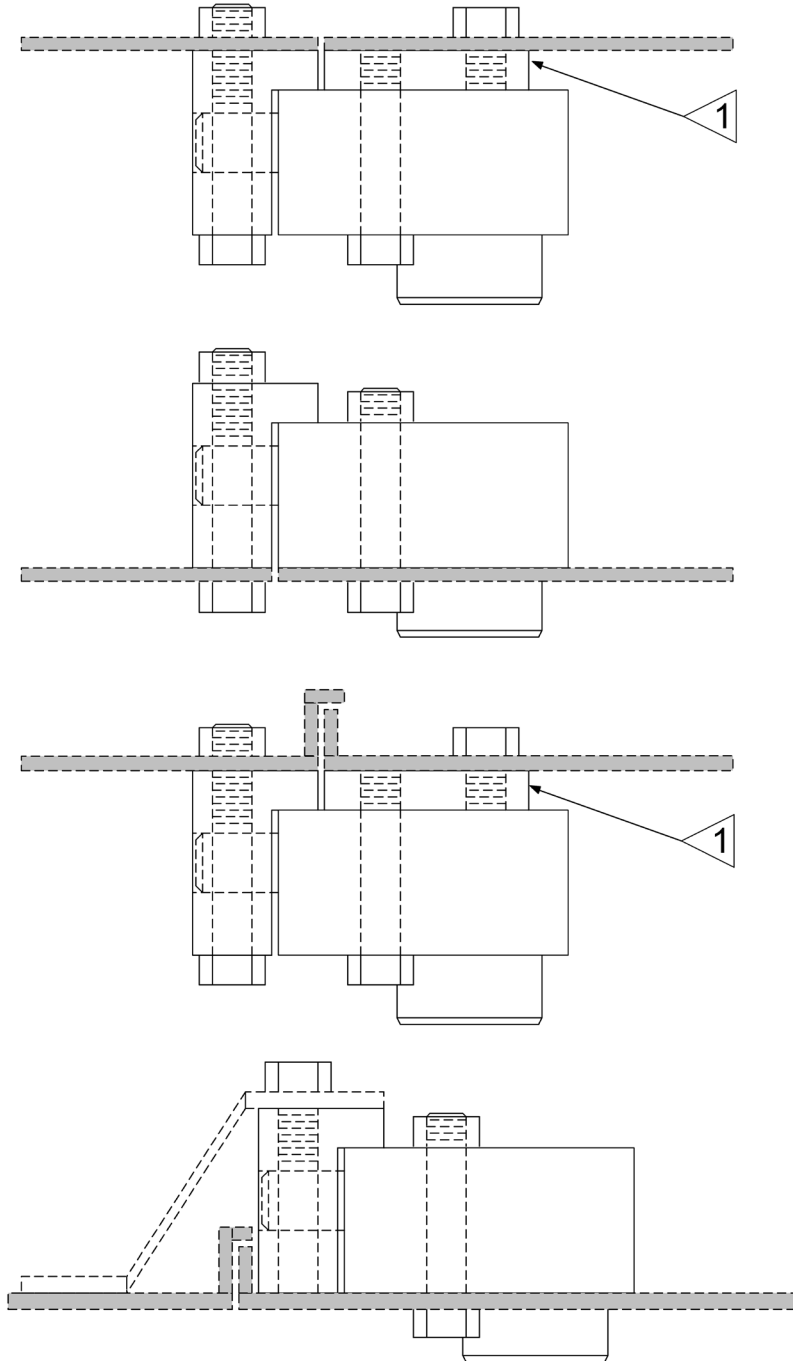

NOTES:

1) Shown with optional adapter plate. The Type D interlock can be mounted on either flat or reinforced doors (front and back mounted). See Data Sheet (3.3) for Adapter Plate details.

Type D Access Interlock



DRAWING

Dimensions: in inches

HD Series Type D

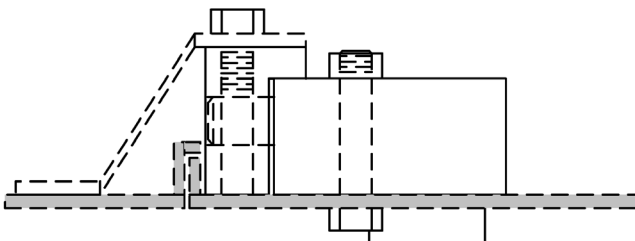
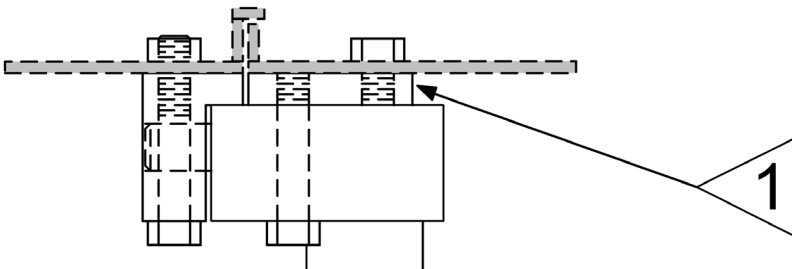
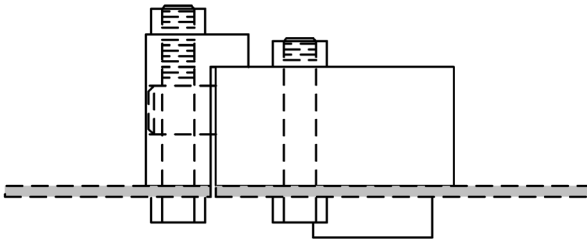
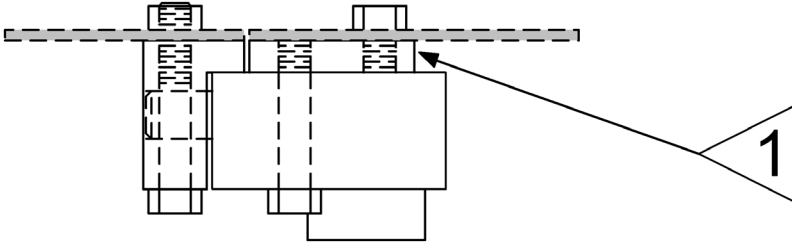

NOTES:

1) Shown with optional adapter plate. The Type D interlock can be mounted on either flat or reinforced doors (front and back mounted). See Data Sheet (3.3) for Adapter Plate details.

Type D Access Interlock



ORDER INFORMATION

	1	2	3	4	5	6	7	8	9	10	11	12	13	14	15
Part number		D	L		-	-	-								

1	Series	K = SD Series (brass)				S = HD Series (stainless)			
4	Auxiliary Switch	0 = none 1 = K DP/DT 3 = S	4 = SS 5 = SSS 6 = SSSS	A = 2 N/O 1 N/C B = 4 N/O 2 N/C	Multi-cylinder HD series standard switch options are only available with 1 - 'E' sequence configuration. For other configurations, please consult our sales team.				
8, 9	Cylinder(s)	SD Series - max cylinders 7				HD Series - max cylinders 7			
		1	0	= E 1 CYL	NOTE: Use numbering logic for up to 7 cylinders	1	0	= E 1 CYL	NOTE: Use numbering logic for up to 7 cylinders
		1	1	= W 1 CYL		1	1	= W 1 CYL	
		2	0	= EE 2 CYL		2	0	= EE 2 CYL	
		2	1	= EW 2 CYL		2	1	= WE 2 CYL	
		3	0	= EEE 3 CYL		3	0	= EEE 3 CYL	
		3	1	= EEW 3 CYL		3	1	= WEE 3 CYL	
		3	2	= EWW 3 CYL		3	2	= WWE 3 CYL	
		HD series, 4 - 7 cylinders require longer lead times. Please consult our sales team.							
10	Stamp Key Interchange max. 5 alphanumeric characters	- = No S = Yes				Stamp Key interchange only available for HD series when protective Flip Open Cover is added			
11	Opposite Hand	- = No H = Opposite Hand				Opposite hand not available for HD Series			
12	Protective Covers see protective covers data sheet	- = No C = Push On F = Flip Open				- = No F = Flip Open with LOTO provision			
13	Mounting Bolts see mounting bolt data sheet	- = No T = Tamperproof							
14	Adapter Plate	- = No P = Adapter Plate				see adapter plate data sheet for more information			
15	Reverse	R = Reverse switch housing relationship							

ACCESSORIES

Short D Plate

The Short D Plate is made of brass or 316 stainless steel and is used to allow for front mounting of a single cylinder Type D. For installation it would be fastened to the back of the single cylinder Type D.

To order with the single cylinder Type D, indicate the letter "P" in column 14 of the Type D ordering guide.

See Adapter Plate data sheet for technical data or to order adapter plate separately.

SD

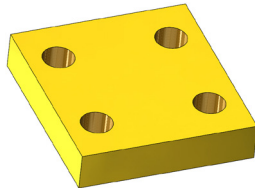

HD

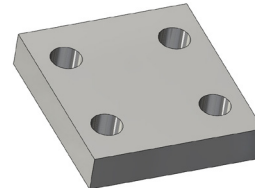

Long D Plate

The Long D Plate is made of brass or 316 stainless steel and is used to allow for front mounting of a multiple cylinder Type D. For installation it would be fastened to the back of the multiple cylinder Type D.

To order with the multiple cylinder Type D, indicate the letter "P" in column 14 of the Type D ordering guide.

See Adapter Plate data sheet for technical data or to order adapter plate separately.

SD

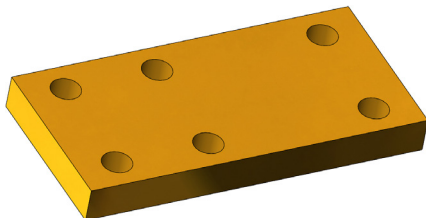

HD



CONTACT INFORMATION

The Kirk Key Interlock Company LLC

9048 Meridian Circle NW North Canton, OH 44720, USA

Toll Free: +1 800-438-2442 O: +1 234-209-9301 F: +1 330-497-4400

9 of 9

Quotes & Inquiries sales@kirkkey.com PO Submission & Orders orders@kirkkey.com

While every effort has been made to ensure the accuracy of the information provided, no liability can be taken for any errors or omission. Kirk Key Interlock Company, LLC reserves the right to alter specifications and introduce improvements without prior notice.

REV (10-21)

www.kirkkey.com