

TONiC™ encoder system

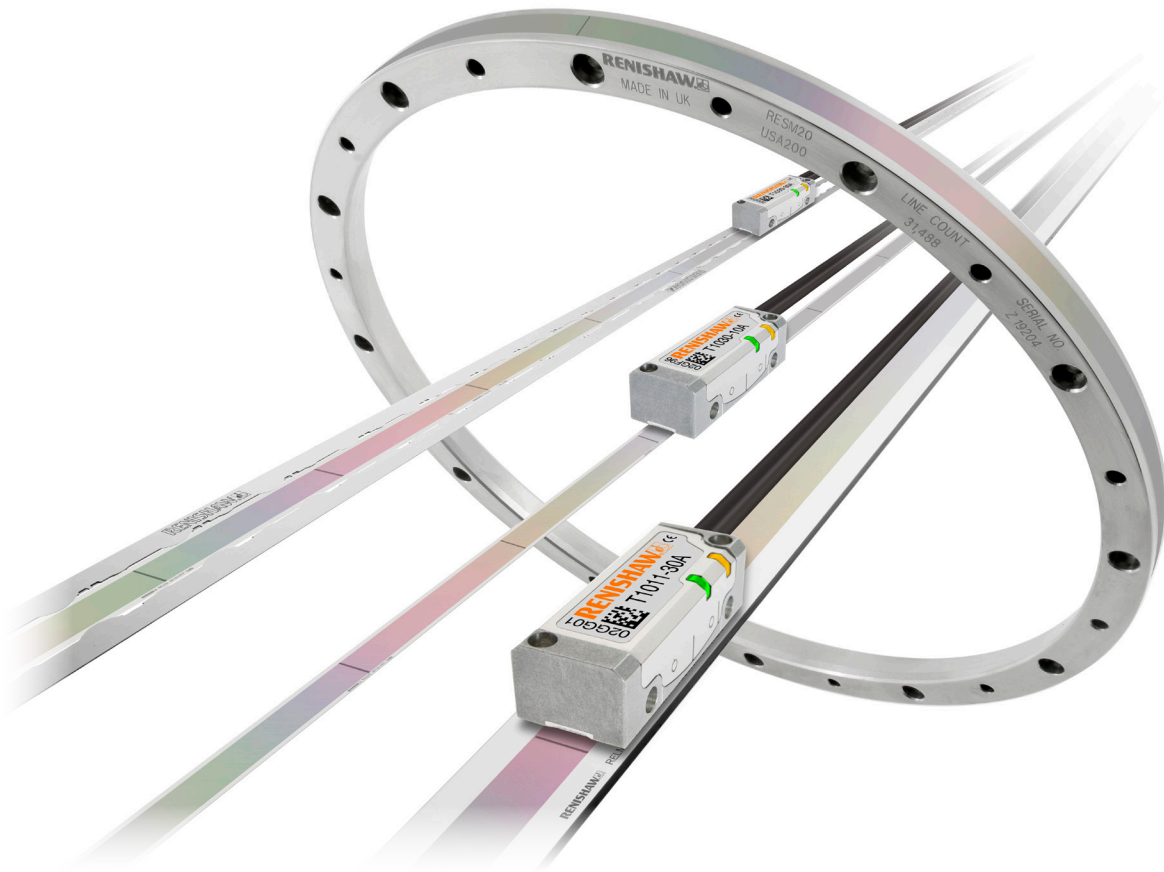

Renishaw's TONiC encoder series is designed for highly-dynamic precision motion systems, bringing higher accuracy, speed and greater reliability to a wide variety of demanding industry sectors.



The readhead is compatible with a wide range of linear, partial arc and rotary scales with bi-directional optical *IN-TRAC*™ reference marks.

For ultimate reliability and high dirt immunity, TONiC encoder system readheads incorporate Renishaw's market proven filtering optics, tuned for even lower noise (jitter), further enhanced by dynamic signal processing including Auto Gain Control (AGC) and Auto Offset Control (AOC). The result is ultra-low sub-divisional error (SDE) giving smoother velocity control for improved scanning performance and increased positional stability.

TONiC encoder system readheads also feature a detachable analogue or digital interface in the form of a robust, convenient connector that can be located up to 10 m from the readhead. The interface offers digital interpolation to 1 nm resolution, with clocked outputs for optimised speed performance at all resolutions for industry-standard controllers.



- **Compact readhead**
(35 mm × 13.5 mm × 10 mm)
- **Compatible with a wide range of linear, partial arc and rotary scales with customer-selectable *IN-TRAC* auto-phase optical reference mark (datum)**
- **Optimised filtering optics for even lower noise (jitter)**
- **Dynamic signal processing provides ultra-low SDE of typically ±30 nm**
- **Auto Gain Control (AGC) ensures consistent signal strength for long-term reliability**
- **Integrated set-up LED for ease of installation**
- **Maximum speed to 10 m/s**
(3.24 m/s at 0.1 μm resolution)
- **Detachables analogue or digital connector with integral interpolation to 1 nm resolution (0.00075 arc seconds)**
- **Integral dual limits (linear only)**
- **Operating temperature to 70 °C**
- **Dual resolution version available**

Compatible scales



Linear scales	RTL20-S	RTL20/FASTRACK™	RKLC20-S†
		Self-adhesive mounted stainless steel tape scale	Stainless steel tape scale and self-adhesive mounted carrier
			
Form (H × W)	0.4 mm × 8 mm including adhesive	RTL20 scale: 0.2 mm × 8 mm FASTRACK carrier: 0.4 mm × 18 mm including adhesive	0.15 mm × 6 mm including adhesive
Accuracy (includes slope and linearity)	±5 µm/m	±5 µm/m	±5 µm/m
Linearity (Figures achievable with two-point error correction)	±2.5 µm/m	±2.5 µm/m	±2.5 µm/m
Maximum length	10 m* (> 10 m available on request)	10 m (> 10 m available on request)	20 m (> 20 m on available request)
Coefficient of thermal expansion (at 20 °C)	10.1 ±0.2 µm/m/°C	10.1 ±0.2 µm/m/°C	Matches that of substrate material when scale ends fixed by epoxy mounted end clamps

* For RTL20-S axis lengths > 2 m, FASTRACK with RTL20 is recommended.

† Suitable for partial arc applications. For more information refer to *RKL scale for partial arc applications* data sheet (Renishaw part no. L-9517-9897).

	RSLM20	RELM20
	Self-adhesive or clip/clamp mounted stainless steel spar scale	Self-adhesive or clip/clamp mounted low-expansion ZeroMet™ spar scale
		
Form (H × W)	1.5 mm × 14.9 mm	1.6 mm × 14.9 mm
Accuracy (includes slope and linearity)	±4 µm (Total accuracy over a complete 5 m length)	±1 µm (Total accuracy up to 1 m)
Linearity (Figures achievable with two-point error correction)	N/A	N/A
Maximum length	5 m	1.5 m
Coefficient of thermal expansion (at 20 °C)	10.1 ±0.2 µm/m/°C	0.75 ±0.35 µm/m/°C

Rotary scales

	RESM20	REXM20
	Stainless steel ring	Ultra-high accuracy stainless steel ring
		
Accuracy	±0.38 arc second (Graduation accuracy for 550 mm diameter RESM20 ring)	±1 arc second† (Total installed accuracy for 417 mm diameter REXM20 ring)
Ring diameters	52 mm to 550 mm	52 mm to 417 mm
Coefficient of thermal expansion (at 20 °C)	15.5 ±0.5 µm/m/°C	15.5 ±0.5 µm/m/°C

† When using two readheads and an additional DSi interface.

For more information about the scales refer to the relevant scale data sheet which can be downloaded from www.renishaw.com/tonicdownloads

TONiC readhead installation drawing (on RTL20-S scale)



Dimensions and tolerances in mm

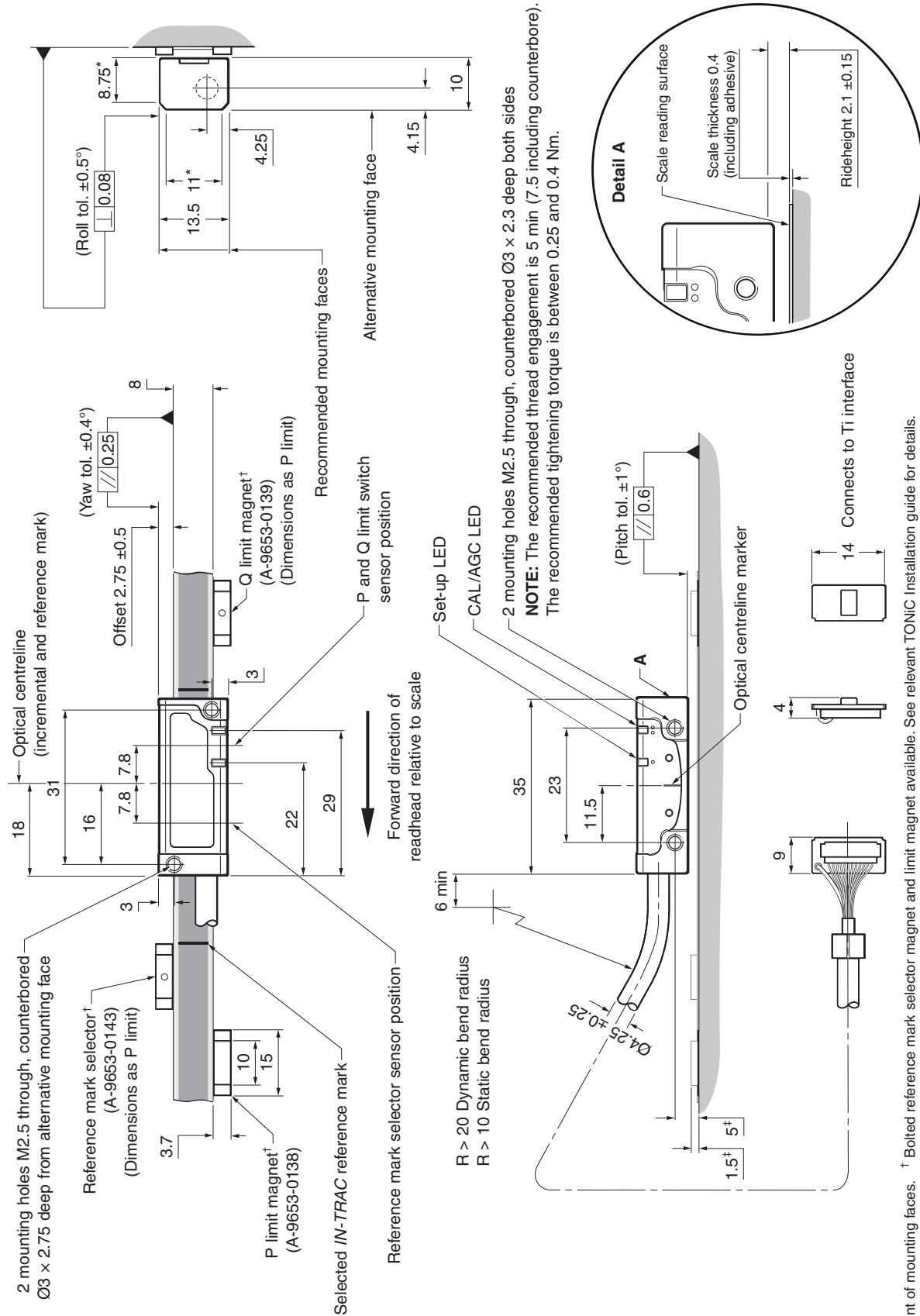

* Extent of mounting faces. † Bolted reference mark selector magnet and limit magnet available. See relevant TONiC Installation guide for details.

‡ Dimensions measured from substrate.

NOTES: RTL20-S only shown. For detailed installation drawings, refer to relevant TONiC installation guide or data sheet.
External magnetic fields greater than 6 mT, in the vicinity of the readhead, may cause false activation of the limit and reference sensors.

TONiC readhead installation drawing (on RESM20 ring)



Dimensions and tolerances in mm

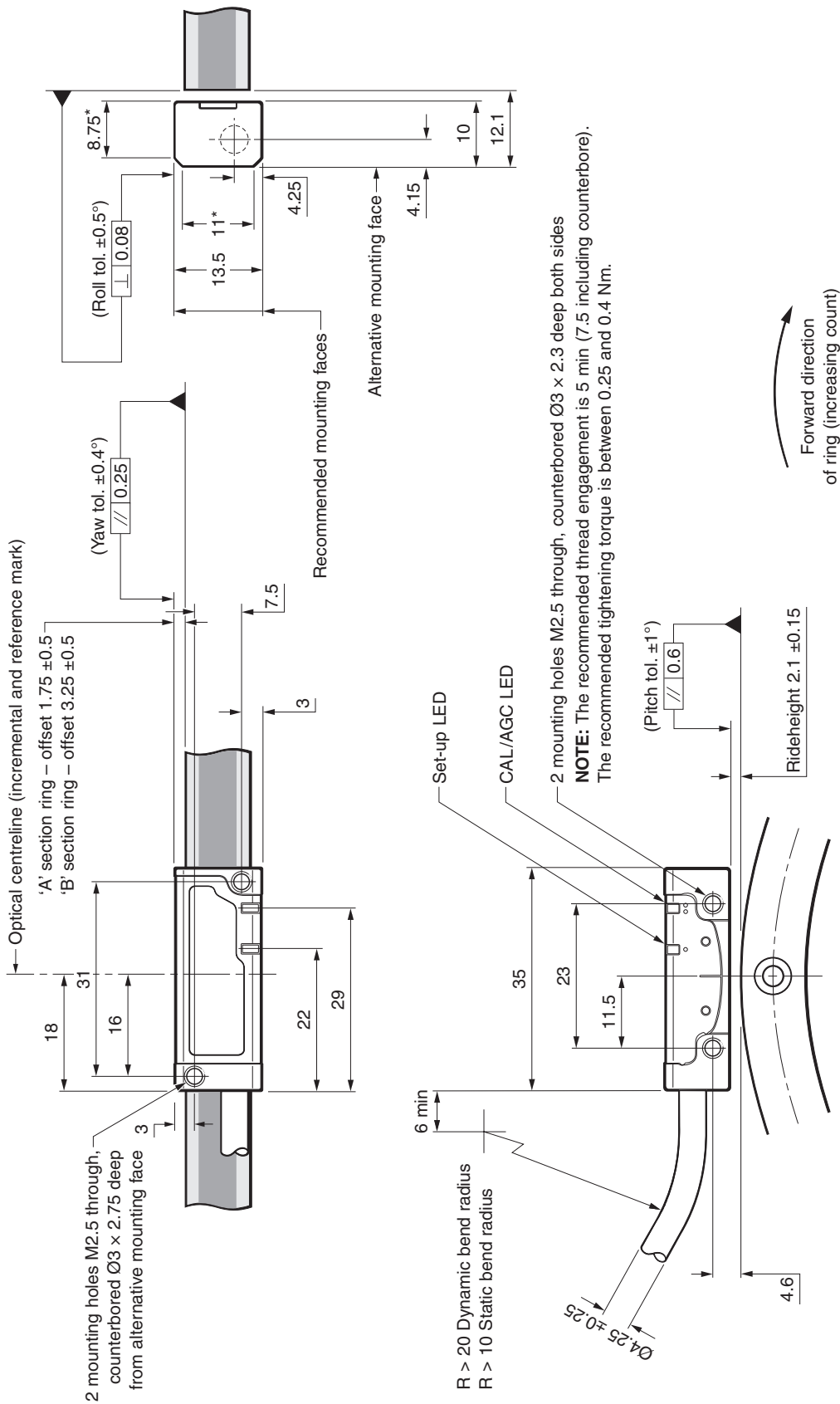

* Extent of mounting faces.
NOTE: External magnetic fields greater than 6 mT, in the vicinity of the readhead, may cause false activation of the limit sensor.

Ti/TD interface dimension drawing

Dimensions and tolerances in mm

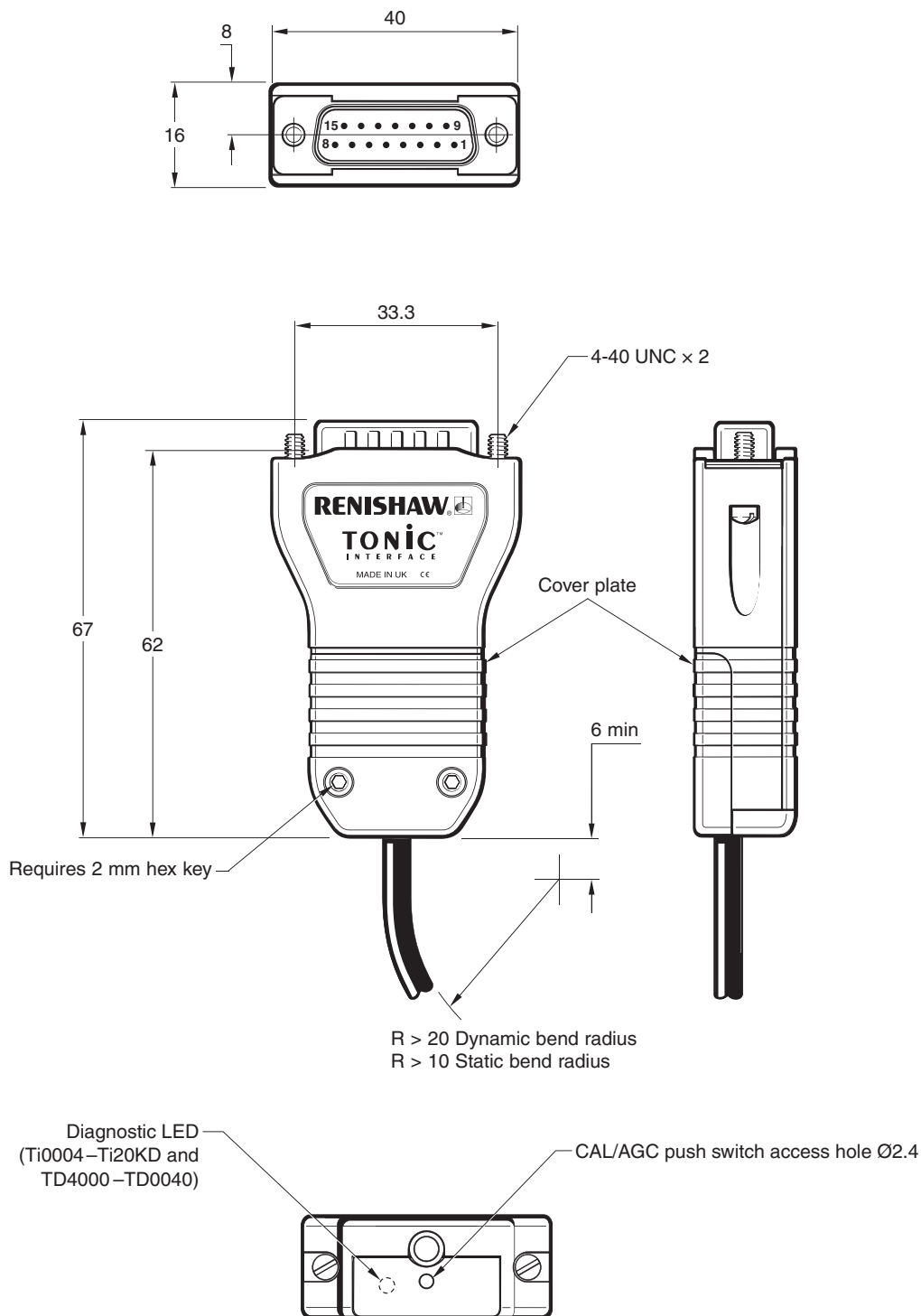

TD dual resolution interface

Allows output to be switched between two resolutions. See TD interface part number section for details of available resolutions.

NOTES:

- ▶ It is recommended that movement should be halted before switching resolutions.
- ▶ No limit outputs.

General specifications

Power supply	5V ±10%	Readhead only < 100 mA T1xxx/T2xxx with Ti0000 < 100 mA T1xxx/T2xxx with Ti0004 - Ti20KD or TD4000 - TD0040 < 200 mA
		NOTE: Current consumption figures refer to unterminated systems. For digital outputs, a further 25 mA per channel pair (eg A+, A-) will be drawn when terminated with 120R. For analogue outputs, a further 20 mA in total will be drawn when terminated with 120R. Power from a 5 Vdc supply complying with the requirements for SELV of standard IEC 60950-1.
	Ripple	200 mVpp maximum @ frequency up to 500 kHz
Temperature (system)	Storage	-20 °C to +70 °C
	Operating	0 °C to +70 °C
Humidity (system)		95% relative humidity (non-condensing) to IEC 60068-2-78
Sealing (readhead) (interface)		IP40
		IP20
Acceleration (readhead)	Operating	500 m/s ² , 3 axes
Shock (system)	Operating	500 m/s ² , 11 ms, ½ sine, 3 axes
Vibration (system)	Operating	100 m/s ² max @ 55 Hz to 2000 Hz, 3 axes
Mass	Readhead	10 g
	Interface	100 g
	Cable	26 g/m
EMC compliance (system)		IEC 61326-1
Readhead cable		Double-shielded, outside diameter 4.25 ±0.25 mm
		Flex life > 20 × 10 ⁶ cycles at 20 mm bend radius
		UL recognised component 
Typical sub-divisional error (SDE)		±30 nm

Speed

Clocked output option (MHz)	Maximum speed (m/s)										
	Ti0004 5 µm	Ti0020 1 µm	Ti0040 0.5 µm	Ti0100 0.2 µm	Ti0200 0.1 µm	Ti0400 50 nm	Ti1000 20 nm	Ti2000 10 nm	Ti4000 5 nm	Ti10KD 2 nm	Ti20KD 1 nm
50	10	10	10	6.48	3.240	1.625	0.648	0.324	0.162	0.065	0.032
40	10	10	10	5.40	2.700	1.350	0.540	0.270	0.135	0.054	0.027
25	10	10	8.10	3.24	1.620	0.810	0.324	0.162	0.081	0.032	0.016
20	10	10	6.75	2.70	1.350	0.670	0.270	0.135	0.068	0.027	0.013
12	10	9	4.50	1.80	0.900	0.450	0.180	0.090	0.045	0.018	0.009
10	10	8.10	4.05	1.62	0.810	0.400	0.162	0.081	0.041	0.016	0.0081
08	10	6.48	3.24	1.29	0.648	0.324	0.130	0.065	0.032	0.013	0.0065
06	10	4.50	2.25	0.90	0.450	0.225	0.090	0.045	0.023	0.009	0.0045
04	10	3.37	1.68	0.67	0.338	0.169	0.068	0.034	0.017	0.0068	0.0034
01	4.2	0.84	0.42	0.16	0.084	0.042	0.017	0.008	0.004	0.0017	0.0008
Analogue output	10 (-3dB)										

NOTE: TD interface maximum speeds are resolution dependent as defined above.

Angular speed depends on ring diameter – use the following equation to convert to rev/min:

$$\text{Angular speed (rev/min)} = \frac{V \times 1000 \times 60}{\pi D} \quad \text{Where } V = \text{maximum linear speed (m/s) and } D = \text{external diameter of RESM20 or REXM20 ring (mm).}$$

Output signals

Digital outputs

Function	Signal	Interface		
		Ti0004 – Ti20KD	TD4000 – TD0040	
Power	5 V	7, 8	7, 8	
	0 V	2, 9	2, 9	
Incremental	A	+	14	14
		-	6	6
	B	+	13	13
		-	5	5
Reference mark	Z	+	12	12
		-	4	4
Limits	P [†]	11	-	
	Q [‡]	10	-	
Set-up	X	1	1	
Alarm [‡]	E	+	-	11
		-	3	3
Resolution switching [‡]	-	-	10	
Shield	Inner	-	-	
	Outer	Case	Case	

[†] Becomes alarm (E+) for Ti options E, F, G, H.

[‡] The alarm signal can be output as a line driven signal or 3-state. Please select the preferred option at time of ordering.

[‡] On TD interfaces pin 10 should be connected to 0 V to switch to lower resolution.

Analogue outputs

Function	Signal	Readhead T1xxx/2xxx	Colour	Interface Ti0000	
Power	5 V		Brown	4, 5	
	0 V		White	12, 13	
Incremental	Cosine	V ₁	+	Red	9
			-	Blue	1
	Sine	V ₂	+	Yellow	10
			-	Green	2
Reference mark	V ₀	+	Violet	3	
		-	Grey	11	
Limits	V _p		Pink	7	
	V _q		Black	8	
Set-up	V _x		Clear	6	
Remote CAL	CAL		Orange	14	
Shield	Inner		Green/Yellow*	-	
	Outer		Outer screen	Case	

* Inner shield is connected to 0 V inside the Ti/TD interface.

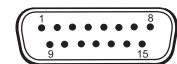

15-pin D-type connector

Electrical connections

Grounding and shielding

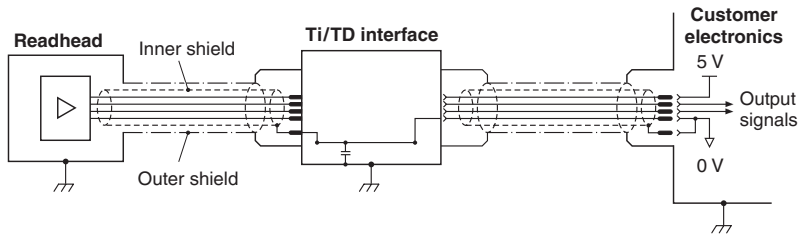

IMPORTANT: The outer shield should be connected to the machine earth (Field Ground). The inner shield should be connected to 0 V at receiving electronics only. Care should be taken to ensure that the inner and outer shields are insulated from each other. If the inner and outer shields are connected together, this will cause a short between 0 V and earth, which could cause electrical noise issues.

Maximum cable length

Readhead to interface: 10 m
Interface to controller: Dependent on clocked output option.
See table below for details.

Receiver clock frequency (MHz)	Maximum cable length (m)
40 to 50	25
< 40	50
analogue	50

Recommended signal termination

Digital outputs

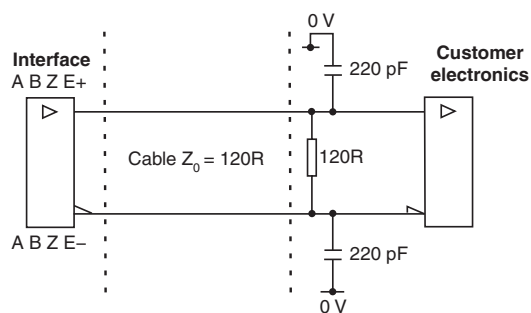

Standard RS422A line receiver circuitry.
Capacitors recommended for improved noise immunity.

Single ended alarm signal termination (Ti options A, B, C, D)

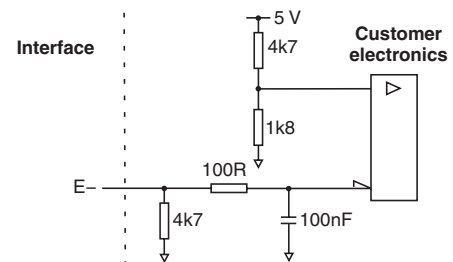

Limit outputs (Ti interface only)

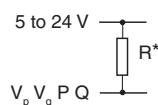

Analogue outputs

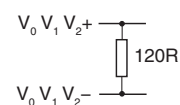

* Select R so maximum current does not exceed 20 mA.
Alternatively, use a suitable relay or opto-isolator.

Output specifications

Digital output signals

Interface models Ti0004 - Ti20KD and TD4000 - TD0040

Form – Square wave differential line driver to EIA RS422A (except limits P and Q)

Incremental* 2 channels A and B in quadrature
(90° phase shifted)

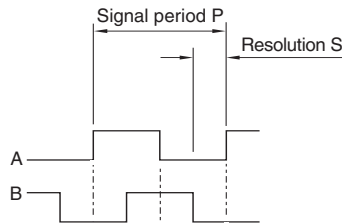

Model	P (μm)	S (μm)
Ti0004	20	5
Ti0020	4	1
Ti0040	2	0.5
Ti0100	0.8	0.2
Ti0200	0.4	0.1
Ti0400	0.2	0.05
Ti1000	0.08	0.02
Ti2000	0.04	0.01
Ti4000	0.02	0.005
Ti10KD	0.008	0.002
Ti20KD	0.004	0.001

Reference*

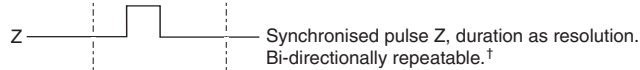

Wide reference*

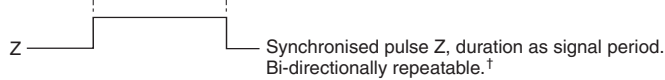

NOTES:

Select 'standard' or 'wide' reference at time of ordering, to match the requirements of the controller being used. Wide reference mark not available on Ti0004.

Limits Open collector output, asynchronous pulse

Digital Ti interfaces only

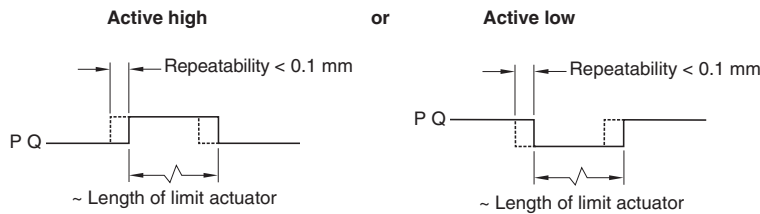

NOTES:

No limits on TD interfaces. P limit becomes E+ for Ti options E, F, G and H.

Alarm*

Line driven (Asynchronous pulse)

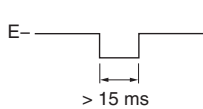

Alarm asserted when:
– Signal amplitude < 20% or > 135%
– Readhead speed too high for reliable operation

Inverse signal E+ only available for Ti options E, F, G and H.

or 3-state alarm

Differentially transmitted signals forced open circuit for > 15 ms when alarm conditions valid.

Set-up‡

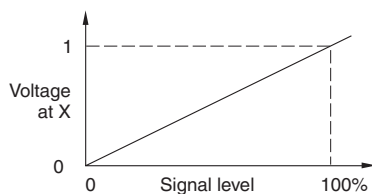

Set-up signal voltage proportional to incremental signal amplitude.

* Inverse signals not shown for clarity.

† Only calibrated reference mark is bi-directionally repeatable.

‡ Set-up signal as shown is not present during calibration routine.

Output specifications (continued)

Analogue output signals

Interface model Ti0000 and direct output from all readheads

Incremental 2 channels V_1 and V_2 differential sinusoids in quadrature, centred on 1.65 V (90° phase shifted)

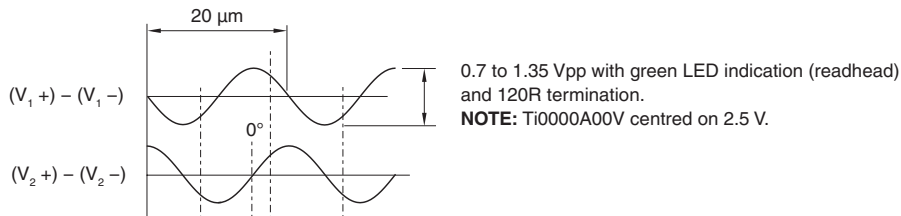

Reference

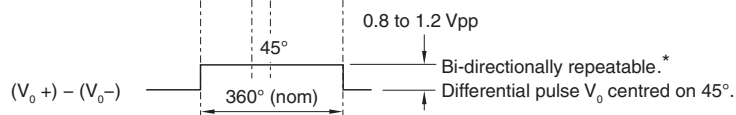

Limits Open collector output, asynchronous pulse

Ti0000 interface only

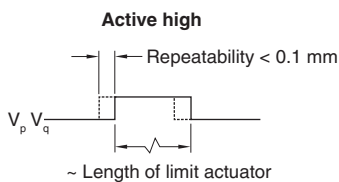

Direct output from readhead

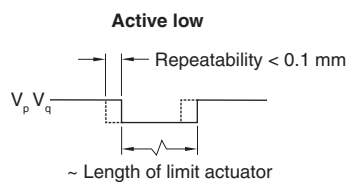

NOTE: Ti0000 interface contains a transistor to invert the readhead's 'active low' signal to give an 'active high' output.

Remote CAL operation (analogue versions only)

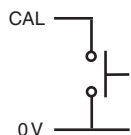

All Ti and TD interfaces include a push-button switch to enable CAL/AGC features.
Remote operation of the CAL/AGC is possible via pin 14 of analogue Ti0000 interfaces.
For applications where no interface is used, remote operation of CAL/AGC is essential.

Set-up†

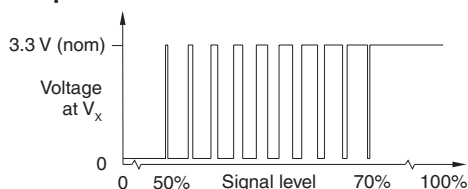

Between 50% and 70% signal level, V_x is a duty cycle.
Time spent at 3.3 V increases with incremental signal level.
At > 70% signal level V_x is nominal 3.3 V.

* Only calibrated reference mark is bi-directionally repeatable.

† Set-up signal as shown is not present during calibration routine.

Linear readhead part numbers

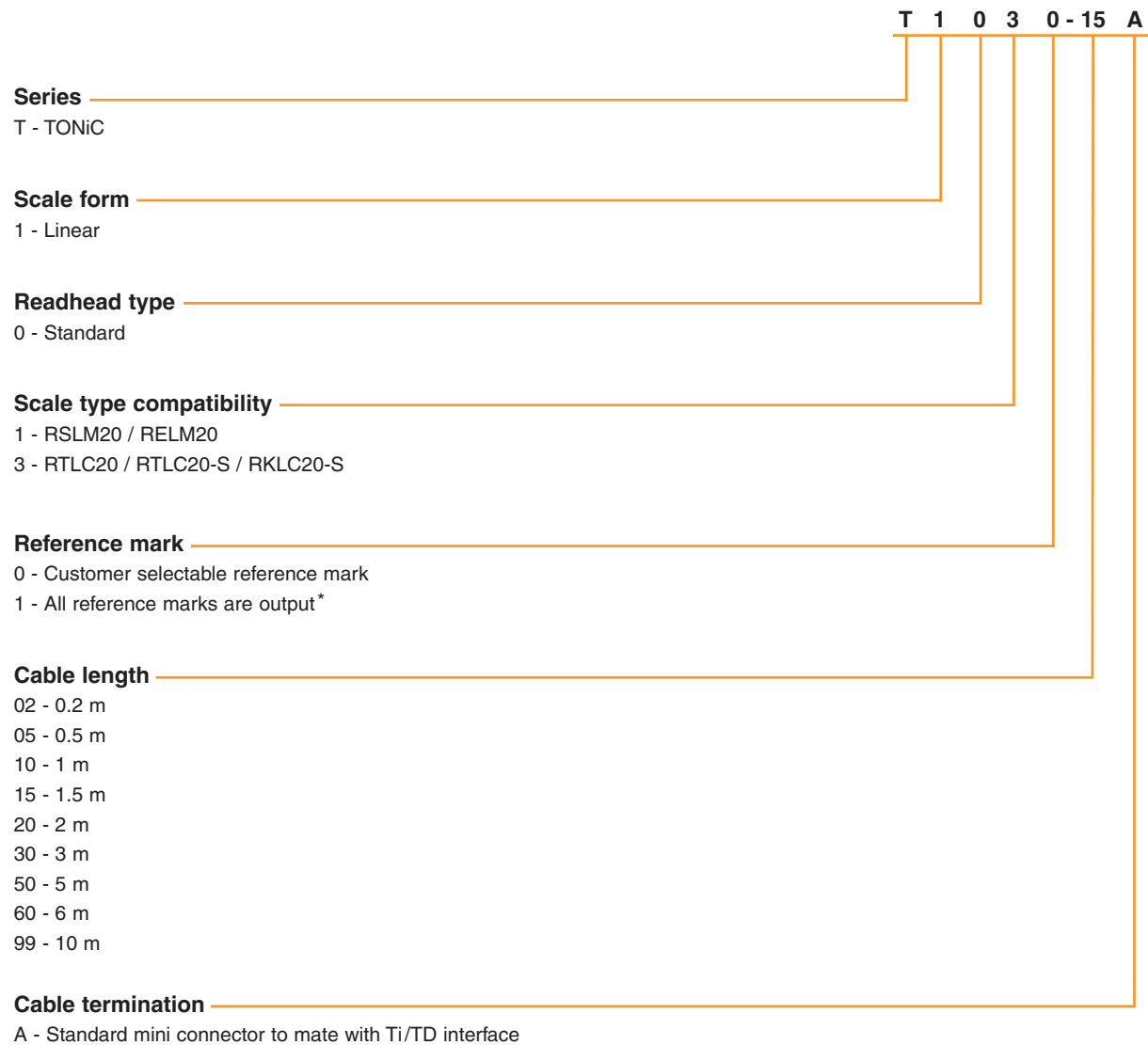

* Only calibrated reference mark is bi-directionally repeatable.

NOTE: Not all combinations are valid. Check valid options online at www.renishaw.com/epc

Rotary readhead part numbers

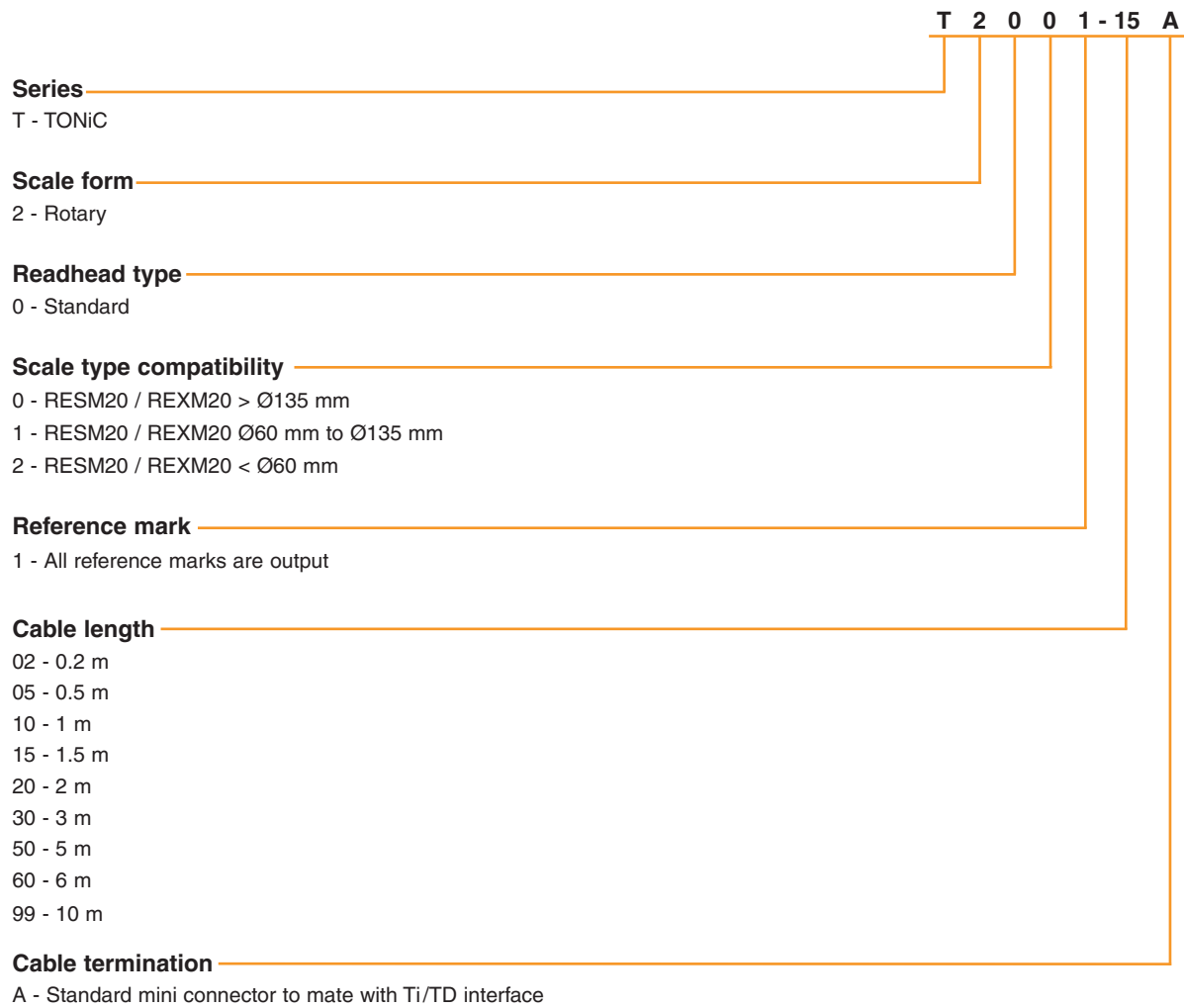

NOTE: Not all combinations are valid. Check valid options online at www.renishaw.com/epc

Partial arc readhead part numbers

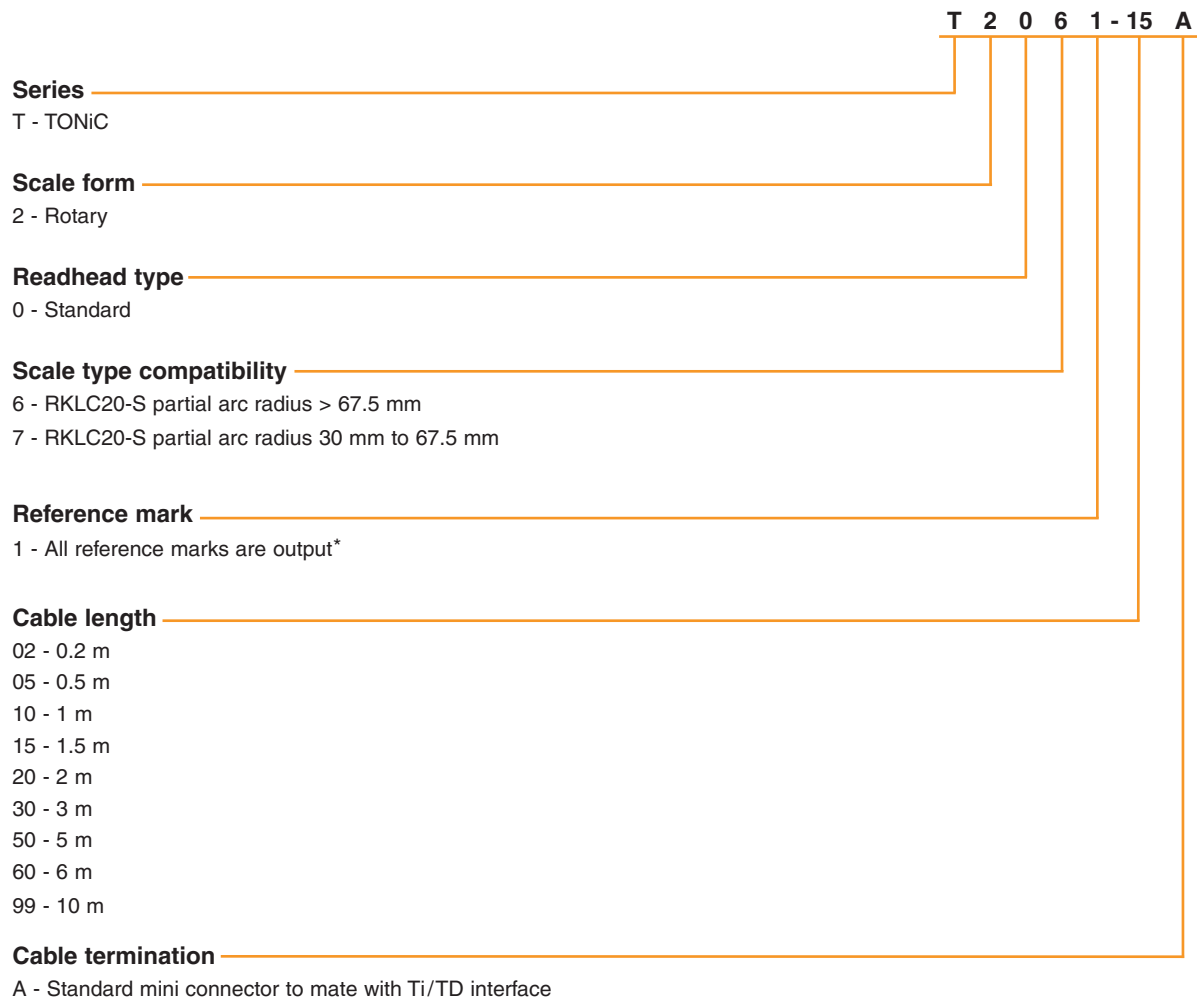

* Only calibrated reference mark is bi-directionally repeatable.

For more information refer to *RKL scale for partial arc applications* data sheet (Renishaw part no. L-9517-9897).

NOTE: Not all combinations are valid. Check valid options online at www.renishaw.com/epc

Ti interface part numbers

Compatible with all TONiC readheads

Analogue:

Ti 0000 A 00 A

Options

- A - Dual active high limits
- V - 2V5 Vmid dual active high limits

Digital:

Ti 0200 A 20 A

Series

Ti - TONiC interface

Interpolation factor/resolution*

0004 - 5 μm^\dagger	1000 - 20 nm
0020 - 1 μm	2000 - 10 nm
0040 - 0.5 μm	4000 - 5 nm
0100 - 0.2 μm	10KD - 2 nm
0200 - 0.1 μm	20KD - 1 nm
0400 - 50 nm	

Alarm format and conditions[†]

- A - Line driven E output; All alarms
- B - Line driven E output; Low signal and high signal alarms only
- E - 3-state; All alarms
- F - 3-state; Low signal and high signal alarms only

Clocked output option[†]

50 - 50 MHz	10 - 10 MHz
40 - 40 MHz	08 - 8 MHz
25 - 25 MHz	06 - 6 MHz
20 - 20 MHz	04 - 4 MHz
12 - 12 MHz	01 - 1 MHz

Options

- A - P/Q limits – ‘active high’, standard reference mark
- B - P/Q limits – ‘active low’, standard reference mark
- C - P/Q limits – ‘active high’, wide reference mark[‡]
- D - P/Q limits – ‘active low’, wide reference mark[‡]
- E - Q limit only – ‘active high’, differential alarm, standard reference mark
- F - Q limit only – ‘active low’, differential alarm, standard reference mark
- G - Q limit only – ‘active high’, differential alarm, wide reference mark[‡]
- H - Q limit only – ‘active low’, differential alarm, wide reference mark[‡]

* Additional interpolation factors available. Contact your local Renishaw representative for further details.

[†] When using with a DSi, the interface should be configured with line driven alarm outputs and a clocked output option of 01, 04, 06, 08, 10, 12 or 20.

[‡] Wide reference mark not available on Ti0004 (5 μm) interfaces.

NOTE: Not all combinations are valid. Check valid options online at www.renishaw.com/epc

TD interface part numbers

Compatible with all TONiC readheads

Dual resolution:

Series

TD - TONiC dual resolution

Interpolation factor/resolution*

Pin 10 open Pin 10 = 0 V

4000 - 5 nm	10 nm
2000 - 10 nm	20 nm
1000 - 20 nm	40 nm
0400 - 50 nm	0.1 µm
0200 - 0.1 µm	0.2 µm
0040 - 0.5 µm	1 µm

Alarm format and conditions†

- A - Line driven, differential output; All alarms
- B - Line driven, differential output; Low signal and high signal alarms only
- E - 3-state; All alarms
- F - 3-state; Low signal and high signal alarms only

Clocked output option†

50 - 50 MHz	10 - 10 MHz
40 - 40 MHz	08 - 8 MHz
25 - 25 MHz	06 - 6 MHz
20 - 20 MHz	04 - 4 MHz
12 - 12 MHz	01 - 1 MHz

Options

- A - Standard reference mark
- B - Wide reference mark

TD 4000 A 20 A

* Additional interpolation factors available. Contact your local Renishaw representative for further details.

† When using with a DSi, the interface should be configured with line driven alarm outputs and a clocked output option of 01, 04, 06, 08, 10, 12 or 20.

NOTE: Not all combinations are valid. Check valid options online at www.renishaw.com/epc

TONiC compatible products

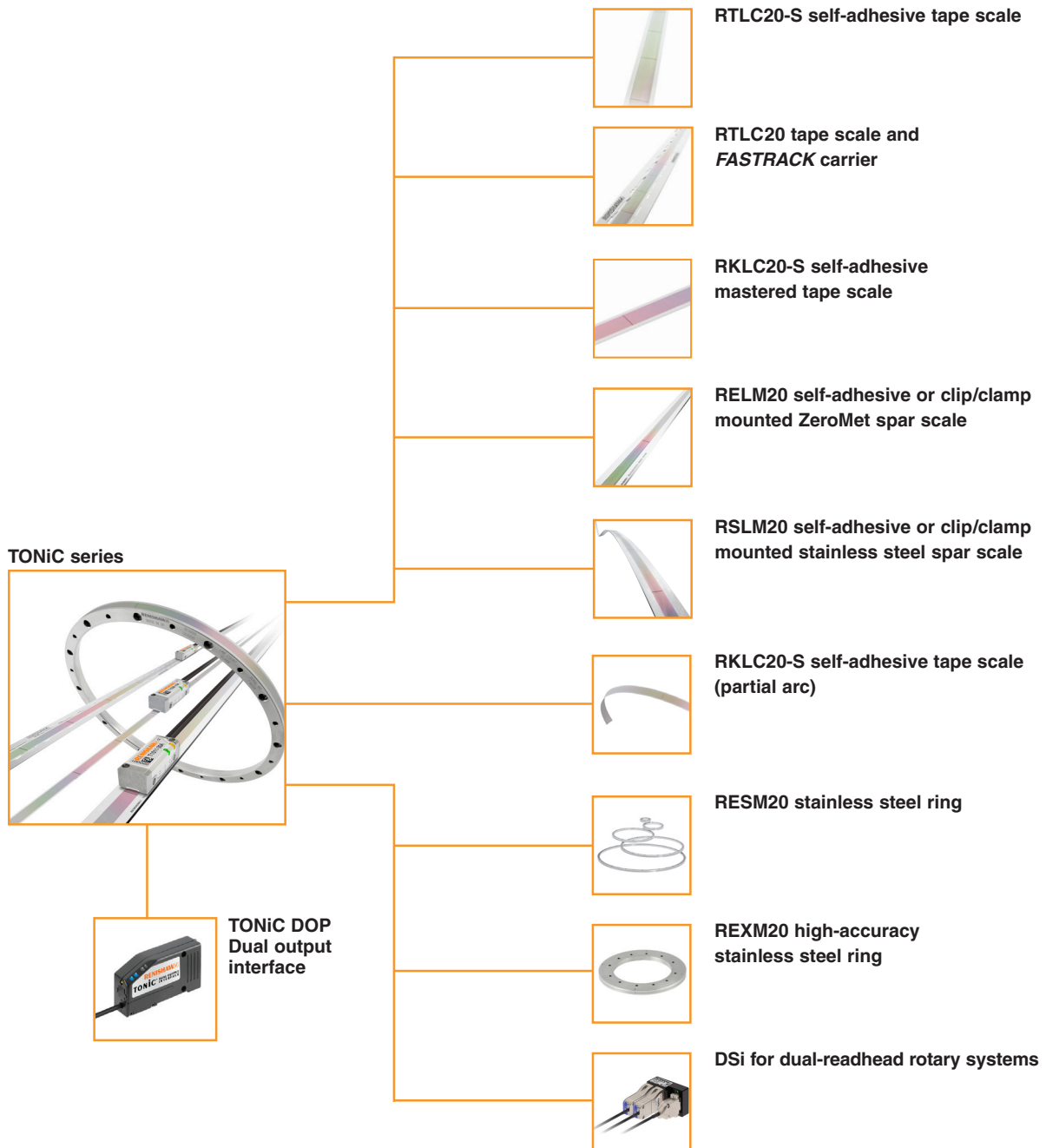

For worldwide contact details, visit www.renishaw.com/contact