

INDUSTRIAL . AUTOMOTIVE . AUTOMATION . ENERGY

INDIVIDUAL INDUSTRIAL SOLUTIONS



INTELLIGENT SOLUTIONS

FOR MORE EFFICIENCY AND SAFETY

INTELLIGENTE LÖSUNGEN

FÜR MEHR EFFIZIENZ UND SICHERHEIT



ANZEIGE 180° PROGRAMMIERBAR

DISPLAY 180° PROGRAMMABLE

2/3 AUSGÄNGE HYSTERESE FREI PROGRAMMIERBAR/4-20MA

2/3 OUTPUTS HYSTERESIS FREE PROGRAMMABLE/4-20MA

LED ANZEIGE

LED DISPLAY

KERAMIKMESSZELLE

CERAMIC SENSING ELEMENT

SCHUTZKLASSE IP67

PROTECTION CLASS IP 67

QUALITY AND INNOVATIONS

FROM GERMANY

QUALITÄT UND INNOVATIONEN

AUS DEUTSCHLAND

FOUNDED IN 1974, PETERS INDU-PRODUKT HAS DEVELOPED INTO A COMPANY THAT OPERATES ON AN INTERNATIONAL BASE. PERFECTION IS OUR CONSTANT AIM AND TECHNICAL KNOWLEDGE IS THE TOOL WE USE TO ACHIEVE IT. WITH THIS STRATEGY, WE HAVE DEVELOPED A STANDARD OF QUALITY THAT HAS CONTINUALLY CONVINCED CUSTOMERS WORLDWIDE. WE ARE CONSTANTLY EXPANDING OUR PRODUCT PORTFOLIOS IN THE INDUSTRIAL, AUTOMOTIVE, AUTOMATION AND ENERGY FIELDS. MOREOVER, WE DEVELOP TAILOR-MADE SOLUTIONS THAT SUIT THE NEEDS OF OUR CUSTOMERS – RIGHT FROM THE INITIAL IDEA TO THE FINISHED PRODUCT.

SEIT DEM GRÜNDUNGSJAHR 1974 HAT SICH PETERS INDU-PRODUKT ZU EINEM UNTERNEHMEN MIT INTERNATIONALEM WIRKUNGSKREIS ENTWICKELT. PERFEKTION IST UNSER ANSPRUCH UND TECHNISCHES KNOW-HOW IST UNSER WERKZEUG. AUF DIESE WEISE HABEN WIR EIN QUALITÄTSNIVEAU ENTWICKELT, DAS KUNDEN WELTWEIT ÜBERZEUGT. UNSERE PRODUKTPORTFOLIOS IN DEN BEREICHEN INDUSTRIAL, AUTOMOTIVE, AUTOMATION UND ENERGY ERWEITERN WIR LAUFEND. DARÜBER HINAUS ENTWICKELN WIR VON DER ERSTEN IDEE BIS ZUM FERTIGEN PRODUKT INDIVIDUELLE LÖSUNGEN IM KUNDENAUFTRAG.



Our “Industrial” business unit offers not only valve connectors that meet DIN 43 650 and EN 175301-803 standards, but also an entire range that includes pressure switches, pressure transmitters, cylinders, proximity switches, relays and opto-coupler modules. Our connectors and electronic components are widely used in the fields of automation technology, mechanical engineering and plant engineering. In addition to standard connectors, our customers can also choose from a wide customised selection that features varying numbers of contacts as well as various types and lengths of cable. Integrated LED displays and moulded connectors are also available as options. Our range of connectors and built-in plugs can be individually customised to guarantee that our products suit your application.

Please feel free to contact us if you have any questions.

Unser Geschäftsbereich „Industrial“ umfasst neben Ventilsteckverbindern nach DIN 43 650 und EN 175301-803 unter anderem Druckschalter, Drucktransmitter, Zylinder Näherungsschalter sowie Relais und Optokoppler. Verwendung finden unsere Steckverbindungen und elektronischen Bauteile in der Automatisierungstechnik sowie im Maschinen- und Anlagenbau. Neben den Standard-Steckverbindern bieten wir unseren Kunden eine große Auswahl an verschiedenen Polzahlen, Kabeltypen und Kabellängen. Auch die Integration von LED-Anzeigen und die Umspritzung der Steckverbindungen ist optional verfügbar. Mit unserem Angebot an konfektionierbaren Steckverbindern und Einbausteckern gewährleisten wir einen individuellen Einsatz unserer Produkte passend zu Ihrer Applikation.

Sprechen Sie uns an, wenn Sie Fragen haben. Wir stehen Ihnen gerne als Ansprechpartner zur Verfügung.



ORDER CODE/TYPENSCHLÜSSEL

EN 175301-803

G – Connector/Gerätesteckdose

D – DIN

I – Industrial/Industrienorm

A – Form A/Bauform A

B – Form B/Bauform B

C – Form C/Bauform C

3 – 3-poles/3-polig

4 – 4-poles/4-polig

0 – Without circuit/ohne Beschaltung

Y – LED yellow/LED gelb

G – LED green/LED grün

R – LED red/LED rot

D – Diode

T – Z-Diode (Transil)

L – Rectifier/Gleichrichter

V – Varistor

E – Amplifier/Verstärker

H1 (...9) – Pressure switch/Druckschalter

C – Capacitor/Kondensator

S – Special circuit/Sonderbeschaltung

1 – PG 11

9 – PG 9

7 – PG 7

M – M16x1.5

Position protective earth contact/Position PE-Kontakt

0 – PE 12h

6 – PE 6h

3 – PE 3h

9 – PE 9h

S – Black/schwarz

G – Grey/grau

T – Transparent

1 – 12 Volt

2 – 24 Volt

4 – 48 Volt

5 – 115 Volt

6 – 230 Volt

1 – Profile gasket/Profildichtung

2 – Flat gasket/Flachdichtung

1 – PVC cable/PVC Leitung

2 – PUR cable/PUR Leitung

1 – 1 m

3 – 3 m

5 – 5 m

0 – 10 m

H – High version/hohe Bauform

R – Knurled screw/Rändelschraube

S – Special gland black/Sonderverschraubung schwarz

G – Special gland grey/Sonderverschraubung grau

M – M12-connection/M12-Anschluß

EXAMPLE/BEISPIEL

G D A 3 Y V 9 0 T 2 1 1 5 R S

CONNECTOR/STECKVERBINDER A

3- OR 4-POLE/3- ODER 4-POLIG

Connector/Steckverbinder A
3- or 4-pole/3- oder 4-polig

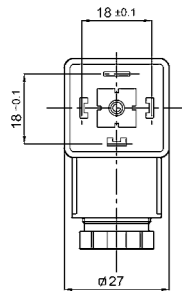

DETAILS

_ DIN 43650/EN 175301-803	_ DIN 43650/EN 175301-803
_ Contact spacing 18 mm	_ Kontaktabstand 18 mm
_ Rated voltage 250 VAC/300 VDC	_ Nennspannung 250 VAC/300 VDC
_ Operating current 10 A	_ Dauerstrom 10 A
_ Max. current 16 A	_ Max. Strom 16 A
_ Max. wire gauge 1,5 mm ²	_ Max. Leiterquerschnitt 1,5 mm ²
_ Cable gland PG9/PG11/M16 optional	_ Kabelverschraubung PG9/PG11/M16 optional
_ Cable diameter 6–8 mm/ 8–10 mm	_ Leitungsdurchmesser 6–8 mm/ 8–10 mm
_ Protection class IP65 (EN 60529)	_ Schutzart IP65 (EN 60529)
_ Housingmaterial PA+30%GF	_ Gehäusematerial PA+30%GF
_ Contactmaterial CuZn (Ag)	_ Kontaktmaterial CuZn (Ag)
_ Gasket (profil=1 / flat=2)* thermoplastic rubber	_ Dichtung (Profil=1 / Flach=2)* thermoplastisches Gummi
_ Screw M3	_ Befestigungsschraube M3
_ Temperature range –40 °C to +125 °C	_ Temperaturbereich –40 °C bis +125 °C

CONNECTOR/STECKVERBINDER A

WITH CIRCUIT/MIT BESCHALTUNG

Connector/Steckverbinder A
with circuit/mit Beschaltung

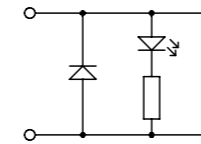

YD: LED+Diode 24 VDC

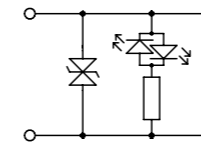

YT: LED+Z-Diode 24 VAC/DC

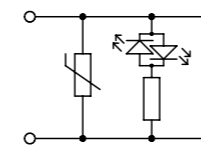

YV: LED+Varistor 24 VAC/DC

DETAILS

_ DIN 43650/EN 175301-803	_ DIN 43650/EN 175301-803
_ Contact spacing 18 mm	_ Kontaktabstand 18 mm
_ Rated voltage 250 VAC/300 VDC	_ Nennspannung 250 VAC/300 VDC
_ Operating current 10 A	_ Dauerstrom 10 A
_ Max. current 16 A	_ Max. Strom 16 A
_ Max. wire gauge 1,5 mm ²	_ Max. Leiterquerschnitt 1,5 mm ²
_ Cable gland PG9/PG11/M16 optional	_ Kabelverschraubung PG9/PG11/M16 optional
_ Cable diameter 6–8 mm	_ Leitungsdurchmesser 6–8 mm
_ Protection class IP65 (EN 60529)	_ Schutzart IP65 (EN 60529)
_ Housingmaterial PA	_ Gehäusematerial PA
_ Contactmaterial CuZn (Ag)	_ Kontaktmaterial CuZn (Ag)
_ Gasket (profil=1 / flat=2)* thermoplastic rubber	_ Dichtung (Profil=1 / Flach=2)* thermoplastisches Gummi
_ Screw M3	_ Befestigungsschraube M3
_ Temperature range –30 °C to +90 °C	_ Temperaturbereich –30 °C bis +90 °C

CONNECTOR/STECKVERBINDER A/B WITH PWM/MIT PWM WANDLER

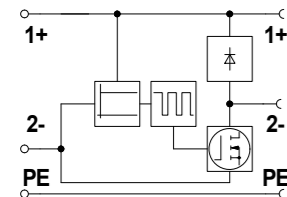
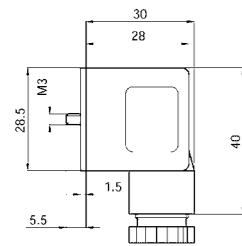
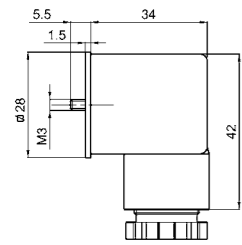

Connector/Steckverbinder A/B
with PWM/mit PWM



DETAILS

_ DIN 43650/EN 175301-803

_ Contact spacing 18 mm/11 mm

_ Rated voltage 24 VDC/24 V

_ Current 4 A/2 A

_ On time 100% 1 s upon request

_ Holding power after 1s 40% upon request

_ PWM frequency 250 Hz/1000 Hz

_ Cable diameter 6–8 mm

_ Protection class IP65 (EN 60529)

_ Housingmaterial PA

_ Contactmaterial CuZn (Ag)

_ Gasket flat thermoplastic rubber

_ Screw M3

_ Temperature range –30 °C to +70 °C

_ DIN 43650/EN 175301-803

_ Kontaktabstand 18 mm/11 mm

_ Nennspannung 24 VDC/24 V

_ Strom 4 A/2 A

_ Einschaltdauer 100% 1 s auf Anfrage

_ Halteleistung nach 1s 40% auf Anfrage

_ PWM Frequenz 250 Hz/1000 Hz

_ Leitungsdurchmesser 6–8 mm

_ Schutzart IP65 (EN 60529)

_ Gehäusematerial PA

_ Kontaktmaterial CuZn (Ag)

_ Profildichtung thermoplastisches Gummi

_ Befestigungsschraube M3

_ Temperaturbereich –30 °C bis +70 °C

ORDER CODE/BESTELNUMMERN CONNECTOR/STECKVERBINDER A

CONNECTOR/STECKVERBINDER A, 3- OR 4-POLE/3- ODER 4-POLIG



Type/Ausführung	PG9	PG11
Colour	Contacts	Part No.
Farbe	Polzahl	Artikel Nr.
black/schwarz	2+PE	GDA3090S61
black/schwarz	3+PE	GDA4090S61
grey/grau	2+PE	on request/auf Anfrage
grey/grau	3+PE	on request/auf Anfrage

CONNECTOR/STECKVERBINDER A, WITH CIRCUIT/MIT BESCHALTUNG



Type/Ausführung	PG9	M16
Colour	Contacts	Part No.
Farbe	Polzahl	Artikel Nr.
transparent	2+PE	GDA3YD90T21
transparent	2+PE	GDA3YT90T21
transparent	2+PE	GDA3YV90T21

CONNECTOR/STECKVERBINDER A, WITH PWM/MIT PWM WANDLER



Type	Part No.	Special Feature
Typ	Artikel Nr.	Besonderheit
100 VA	709153	processor controlled/prozessorgesteuert
B	719076	processor controlled/prozessorgesteuert

CONNECTOR/STECKVERBINDER B

STYLE B IND./STYLE B DIN/EN

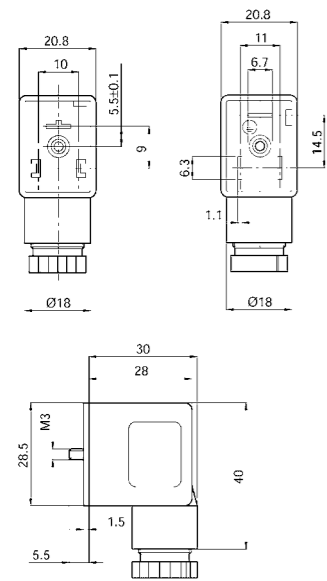

Connector/Steckverbinder B
B-Ind. or/oder B-DIN/EN



DETAILS

- _ Industrial/DIN 43650/EN 175301-803
- _ Contact spacing 10 mm (DIN/EN), 11 mm (Industrial)
- _ Rated voltage 250 VAC/300 VDC
- _ Operating current 6 A
- _ Max. current 10 A
- _ Max. wire gauge 1,5 mm²
- _ Cable gland PG9/M16 optional
- _ Cable diameter 6–8 mm
- _ Protection class IP65 (EN 60529)
- _ Housingmaterial PA+30%GF
- _ Contactmaterial CuZn (Ag)
- _ Gasket (profil=1 / flat=2)* thermoplastic rubber
- _ Screw M3
- _ Temperature range –40 °C to +125 °C

- _ Industrial/DIN 43650/EN 175301-803
- _ Kontaktabstand 10 mm (DIN/EN), 11 mm (Industrial)
- _ Nennspannung 250 VAC/300 VDC
- _ Dauerstrom 6 A
- _ Max. Strom 10 A
- _ Max. Leiterquerschnitt 1,5 mm²
- _ Kabelverschraubung PG9/M16 optional
- _ Leitungsdurchmesser 6–8 mm
- _ Schutzart IP65 (EN 60529)
- _ Gehäusematerial PA+30%GF
- _ Kontaktmaterial CuZn (Ag)
- _ Dichtung (Profil=1 / Flach=2)* thermoplastisches Gummi
- _ Befestigungsschraube M3
- _ Temperaturbereich –40 °C bis +125 °C

CONNECTOR/STECKVERBINDER B

WITH CIRCUIT/MIT BESCHALTUNG

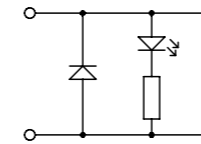

YD: LED+Diode 24 VDC

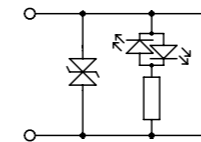

YT: LED+Z-Diode 24 VAC/DC

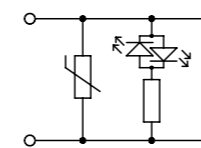

YV: LED+Varistor 24 VAC/DC

Connector/Steckverbinder B
with circuit/mit Beschaltung



DETAILS

- _ Industrial/DIN 43650/EN 175301-803
- _ Contact spacing 10 mm (DIN/EN), 11 mm (Industrial)
- _ Rated voltage 24 V
- _ Operating current 6 A
- _ Max. current 10 A
- _ Max. wire gauge 1,5 mm²
- _ Cable gland PG9/M16 optional
- _ Cable diameter 6–8 mm
- _ Protection class IP65 (EN 60529)
- _ Housingmaterial PA
- _ Contactmaterial CuZn (Ag)
- _ Gasket (profil=1 / flat=2)* thermoplastic rubber
- _ Screw M3
- _ Temperature range –30 °C to +90 °C

- _ Industrial/DIN 43650/EN 175301-803
- _ Kontaktabstand 10 mm (DIN/EN), 11 mm (Industrial)
- _ Nennspannung 24 V
- _ Dauerstrom 6 A
- _ Max. Strom 10 A
- _ Max. Leiterquerschnitt 1,5 mm²
- _ Kabelverschraubung PG9/M16 optional
- _ Leitungsdurchmesser 6–8 mm
- _ Schutzart IP65 (EN 60529)
- _ Gehäusematerial PA
- _ Kontaktmaterial CuZn (Ag)
- _ Dichtung (Profil=1 / Flach=2)* thermoplastisches Gummi
- _ Befestigungsschraube M3
- _ Temperaturbereich –30 °C bis +90 °C

ORDER CODE/BESTELLNUMMERN CONNECTOR/STECKVERBINDER B+C

CONNECTOR/STECKVERBINDER B, STYLE B-IND. OR/ODER B-DIN/EN



Type/Ausführung		10 mm	11 mm
Colour	Contacts	Part No.	Part No.
Farbe	Polzahl	Artikel Nr.	Artikel Nr.
black/schwarz	2+PE	GDB3090S61	GIB3090S61
grey/grau	2+PE	on request/auf Anfrage	on request/auf Anfrage

CONNECTOR/STECKVERBINDER B, WITH CIRCUIT/MIT BESCHALTUNG



Type/Ausführung		10 mm	11 mm	
Colour	Contacts	Part No.	Part No.	Circuit
Farbe	Polzahl	Artikel Nr.	Artikel Nr.	Beschaltung
transparent	2+PE	GDB3YD90T21	GIB3YD90T21	LED+Diode
transparent	2+PE	GDB3YT90T21	GIB3YT90T21	LED+Z-Diode
transparent	2+PE	GDB3YV90T21	GIB3YV90T21	LED+Varistor

CONNECTOR/STECKVERBINDER C, STYLE C-IND. OR/ODER C-DIN/EN



Type/Ausführung		8 mm	9,4 mm
Colour	Contacts	Part No.	Part No.
Farbe	Polzahl	Artikel Nr.	Artikel Nr.
black/schwarz	2+PE	GDC3070S61	GIC3070S61
black/schwarz	3+PE	GDC4070S61	GIC4070S61

CONNECTOR/STECKVERBINDER C, WITH CIRCUIT/MIT BESCHALTUNG



Type/Ausführung		8 mm	9,4 mm	
Colour	Contacts	Part No.	Part No.	Circuit
Farbe	Polzahl	Artikel Nr.	Artikel Nr.	Beschaltung
transparent	2+PE	GDC3YD70T21	GIC3YD70T21	LED+Diode
transparent	2+PE	GDC3YT70T21	GIC3YT70T21	LED+Z-Diode
transparent	2+PE	GDC3YV70T21	GIC3YV70T21	LED+Varistor

PERFECT SOLUTIONS BY GERMAN ENGINEERING

www.peters-indu.de

CONNECTOR/STECKVERBINDER A

MOLDED/ANGESPRITZT

Connector/Steckverbinder A
molded/angespritzt

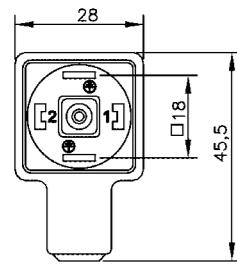

DETAILS

_ DIN 43650/EN 175301-803

_ Contact spacing 18 mm

_ Rated voltage 250 VAC/300 VDC

_ Operating current 10 A

_ PVC-cable 3 x 0,75 mm²/4 x 0,75 mm²

_ Cable diameter 6–7 mm

_ Protection class IP67

_ Housingmaterial PUR

_ Screw M3

_ Temperature range –25 °C to +80 °C

_ DIN 43650/EN 175301-803

_ Kontaktabstand 18 mm

_ Nennspannung 250 VAC/300 VDC

_ Dauerstrom 10 A

_ PVC-Leitung 3 x 0,75 mm²/4 x 0,75 mm²

_ Leitungsdurchmesser 6–7 mm

_ Schutzart IP67

_ Gehäusematerial PUR

_ Befestigungsschraube M3

_ Temperaturbereich –25 °C bis +80 °C

CONNECTOR/STECKVERBINDER A

WITH LED/MIT LED

Connector/Steckverbinder A
with LED/mit LED

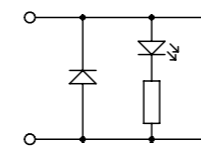

YD: LED+Diode 24 VDC

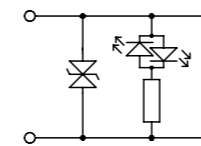

YT: LED+Z-Diode 24 VAC/DC

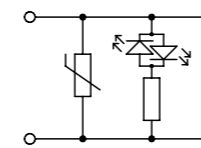

YV: LED+Varistor 24 VAC/DC

DETAILS

_ DIN 43650/EN 175301-803

_ Contact spacing 18 mm

_ Rated voltage 24 V

_ Operating current 5 A

_ Operating indicator LED yellow

_ Protection circuit yes

_ PVC-cable 3 x 0,75 mm²

_ Cable diameter 6–7 mm

_ Protection class IP67

_ Housingmaterial PUR

_ Screw M3

_ Temperature range –25 °C to +80 °C

_ DIN 43650/EN 175301-803

_ Kontaktabstand 18 mm

_ Nennspannung 24 V

_ Dauerstrom 5 A

_ Betriebsanzeige LED gelb

_ Schutzbeschaltung ja

_ PVC-Leitung 3 x 0,75 mm²

_ Leitungsdurchmesser 6–7 mm

_ Schutzart IP67

_ Gehäusematerial PUR

_ Befestigungsschraube M3

_ Temperaturbereich –25 °C bis +80 °C

CONNECTOR/STECKVERBINDER B MOLDED/ANGESPRITZT

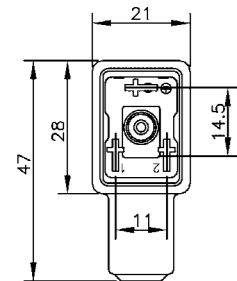
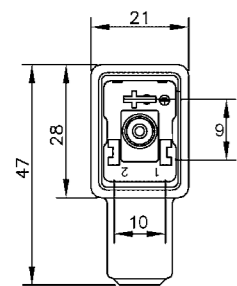

Connector/Steckverbinder B
molded/angespritzt



DETAILS

- | | |
|---|--|
| <ul style="list-style-type: none"> _ Industrial/DIN 43650/EN 175301-803 _ Contact spacing 10 mm (DIN/EN), 11 mm (Industrial) _ Rated voltage 250 VAC/300 VDC _ Operating current 10 A _ PVC-cable 3 x 0,75 mm² _ Cable diameter 6–7 mm _ Protection class IP67 _ Housingmaterial PUR _ Screw M3 _ Temperature range –25 °C to +80 °C | <ul style="list-style-type: none"> _ Industrial/DIN 43650/EN 175301-803 _ Kontaktabstand 10 mm (DIN/EN), 11 mm (Industrial) _ Nennspannung 250 VAC/300 VDC _ Dauerstrom 10 A _ PVC-Leitung 3 x 0,75 mm² _ Leitungsdurchmesser 6–7 mm _ Schutzart IP67 _ Gehäusematerial PUR _ Befestigungsschraube M3 _ Temperaturbereich –25 °C bis +80 °C |
|---|--|

CONNECTOR/STECKVERBINDER B WITH LED/MIT LED

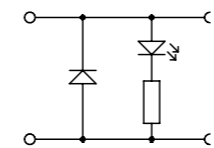

YD: LED+Diode 24 VDC

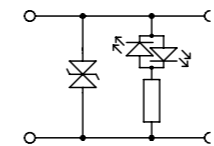

YT: LED+Z-Diode 24 VAC/DC

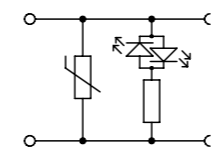

YV: LED+Varistor 24 VAC/DC

Connector/Steckverbinder B
with LED/mit LED



DETAILS

- | | |
|---|--|
| <ul style="list-style-type: none"> _ Industrial/DIN 43650/EN 175301-803 _ Contact spacing 10 mm (DIN/EN), 11 mm (Industrial) _ Rated voltage 24 V _ Operating current 5 A _ Operating indicator LED yellow _ Protection circuit yes _ PVC-cable 3 x 0,75 mm² _ Cable diameter 6–7 mm _ Protection class IP67 _ Housingmaterial PUR _ Screw M3 _ Temperature range –25 °C to +80 °C | <ul style="list-style-type: none"> _ Industrial/DIN 43650/EN 175301-803 _ Kontaktabstand 10 mm (DIN/EN), 11 mm (Industrial) _ Nennspannung 24 V _ Dauerstrom 5 A _ Betriebsanzeige LED gelb _ Schutzbeschaltung ja _ PVC-Leitung 3 x 0,75 mm² _ Leitungsdurchmesser 6–7 mm _ Schutzart IP67 _ Gehäusematerial PUR _ Befestigungsschraube M3 _ Temperaturbereich –25 °C bis +80 °C |
|---|--|

CONNECTOR/STECKVERBINDER C

MOLDED/ANGESPRITZT

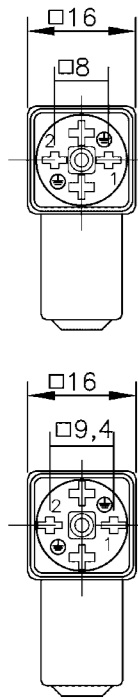

Connector/Steckverbinder C
molded/angespritzt



DETAILS

_ Industrial/DIN 43650/EN 175301-803

_ Contact spacing 8 mm (DIN/EN), 9,4 mm (Industrial)

_ Rated voltage 250 VAC/300 VDC

_ Operating current 6 A

_ PVC-cable 3 x 0,5 mm²

_ Cable diameter 5–6 mm

_ Protection class IP67

_ Housingmaterial PUR

_ Screw M2,5 (DIN/EN), M3 (Industrial)

_ Temperature range –25 °C to +80 °C

_ Industrial/DIN 43650/EN 175301-803

_ Kontaktabstand 8 mm (DIN/EN), 9,4 mm (Industrial)

_ Nennspannung 250 VAC/300 VDC

_ Dauerstrom 6 A

_ PVC-Leitung 3 x 0,5 mm²

_ Leitungsdurchmesser 5–6 mm

_ Schutzart IP67

_ Gehäusematerial PUR

_ Befestigungsschraube M2,5 (DIN/EN), M3 (Industrial)

_ Temperaturbereich –25 °C bis +80 °C

CONNECTOR/STECKVERBINDER C

WITH LED/MIT LED

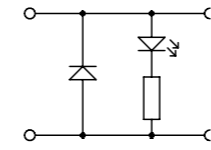

YD: LED+Diode 24 VDC

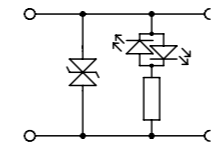

YT: LED+Z-Diode 24 VAC/DC

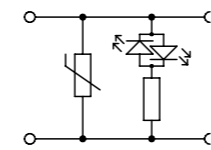

YV: LED+Varistor 24 VAC/DC

Connector/Steckverbinder C
with LED/mit LED



DETAILS

_ Industrial/DIN 43650/EN 175301-803

_ Contact spacing 8 mm (DIN/EN), 9,4 mm (Industrial)

_ Rated voltage 24 V

_ Operating current 3 A

_ Operating indicator LED yellow

_ Protection circuit yes

_ PVC-cable 3 x 0,5 mm²

_ Cable diameter 5–6 mm

_ Protection class IP67

_ Housingmaterial PUR

_ Screw M2,5 (DIN/EN), M3 (Industrial)

_ Temperature range –25 °C to +80 °C

_ Industrial/DIN 43650/EN 175301-803

_ Kontaktabstand 8 mm (DIN/EN), 9,4 mm (Industrial)

_ Nennspannung 24 V

_ Dauerstrom 3 A

_ Betriebsanzeige LED gelb

_ Schutzbeschaltung ja

_ PVC-Leitung 3 x 0,5 mm²

_ Leitungsdurchmesser 5–6 mm

_ Schutzart IP67

_ Gehäusematerial PUR

_ Befestigungsschraube M2,5 (DIN/EN), M3 (Industrial)

_ Temperaturbereich –25 °C bis +80 °C

ORDER CODE/BESTELLNUMMERN

CONNECTOR/STECKVERBINDER A+B+C

CONNECTOR/STECKVERBINDER A, MOLDED/ANGESPRITZT



Type/Ausführung		3 m	5 m	10 m
Contact spacing	Contacts	Part No.	Part No.	Part No.
Kontaktabstand	Polzahl	Artikel Nr.	Artikel Nr.	Artikel Nr.
18 mm	2+PE	CDA30US6013	CDA30US6015	CDA30US6010
18 mm	3+PE	CDA40US6013	CDA40US6015	CDA40US6010

CONNECTOR/STECKVERBINDER A, WITH LED/MIT LED



Type/Ausführung		3 m	5 m	10 m	
Contact spacing	Contacts	Part No.	Part No.	Part No.	Circuit
Kontaktabstand	Polzahl	Artikel Nr.	Artikel Nr.	Artikel Nr.	Beschaltung
18 mm	2+PE	CDA3YDUT2013	CDA3YDUT2015	CDA3YDUT2010	LED+Diode
18 mm	2+PE	CDA3YTUT2013	CDA3YTUT2015	CDA3YTUT2010	LED+Z-Diode
18 mm	2+PE	CDA3YVUT2013	CDA3YVUT2015	CDA3YVUT2010	LED+Varistor

CONNECTOR/STECKVERBINDER B, MOLDED/ANGESPRITZT



Type/Ausführung		3 m	5 m	10 m
Contact spacing	Contacts	Part No.	Part No.	Part No.
Kontaktabstand	Polzahl	Artikel Nr.	Artikel Nr.	Artikel Nr.
10 mm (DIN/EN)	2+PE	CDB300S6013	CDB300S6015	CDB300S6010
11 mm (Industrial)	2+PE	CIB300S6013	CIB300S6015	CIB300S6010

CONNECTOR/STECKVERBINDER B, WITH LED/MIT LED



Type/Ausführung		3 m	5 m	10 m	
Contact spacing	Contacts	Part No.	Part No.	Part No.	Circuit
Kontaktabstand	Polzahl	Artikel Nr.	Artikel Nr.	Artikel Nr.	Beschaltung
10 mm (DIN/EN)	2+PE	CDB3YD0T2013	CDB3YD0T2015	CDB3YD0T2010	LED+Diode
10 mm (DIN/EN)	2+PE	CDB3YT0T2013	CDB3YT0T2015	CDB3YT0T2010	LED+Z-Diode
10 mm (DIN/EN)	2+PE	CDB3YV0T2013	CDB3YV0T2015	CDB3YV0T2010	LED+Varistor
11 mm (Industrial)	2+PE	CIB3YD0T2013	CIB3YD0T2015	CIB3YD0T2010	LED+Diode
11 mm (Industrial)	2+PE	CIB3YT0T2013	CIB3YT0T2015	CIB3YT0T2010	LED+Z-Diode
11 mm (Industrial)	2+PE	CIB3YV0T2013	CIB3YV0T2015	CIB3YV0T2010	LED+Varistor

CONNECTOR/STECKVERBINDER C, MOLDED/ANGESPRITZT



Type/Ausführung		3 m	5 m	10 m
Contact spacing	Contacts	Part No.	Part No.	Part No.
Kontaktabstand	Polzahl	Artikel Nr.	Artikel Nr.	Artikel Nr.
8 mm (DIN/EN)	2+PE	CDC30US6013	CDC30US6015	CDC30US6010
9,4 mm (Industrial)	2+PE	CIC30US6013	CIC30US6015	CIC30US6010

CONNECTOR/STECKVERBINDER C, WITH LED/MIT LED



Type/Ausführung		3 m	5 m	10 m	
Contact spacing	Contacts	Part No.	Part No.	Part No.	Circuit
Kontaktabstand	Polzahl	Artikel Nr.	Artikel Nr.	Artikel Nr.	Beschaltung
8 mm (DIN/EN)	2+PE	CDC3YDUT2013	CDC3YDUT2013	CDC3YDUT2010	LED+Diode
8 mm (DIN/EN)	2+PE	CDC3YTUT2013	CDC3YTUT2013	CDC3YTUT2010	LED+Z-Diode
8 mm (DIN/EN)	2+PE	CDC3YVUT2013	CDC3YVUT2013	CDC3YVUT2010	LED+Varistor
9,4 mm (Industrial)	2+PE	CIC3YDUT2013	CIC3YDUT2013	CIC3YDUT2010	LED+Diode
9,4 mm (Industrial)	2+PE	CIC3YTUT2013	CIC3YTUT2013	CIC3YTUT2010	LED+Z-Diode
9,4 mm (Industrial)	2+PE	CIC3YVUT2013	CIC3YVUT2013	CIC3YVUT2010	LED+Varistor

BASE CONNECTOR/STIFTPLATTE A

3- OR 4-POLE/3- ODER 4-POLIG, SQUARE/QUADRATISCH

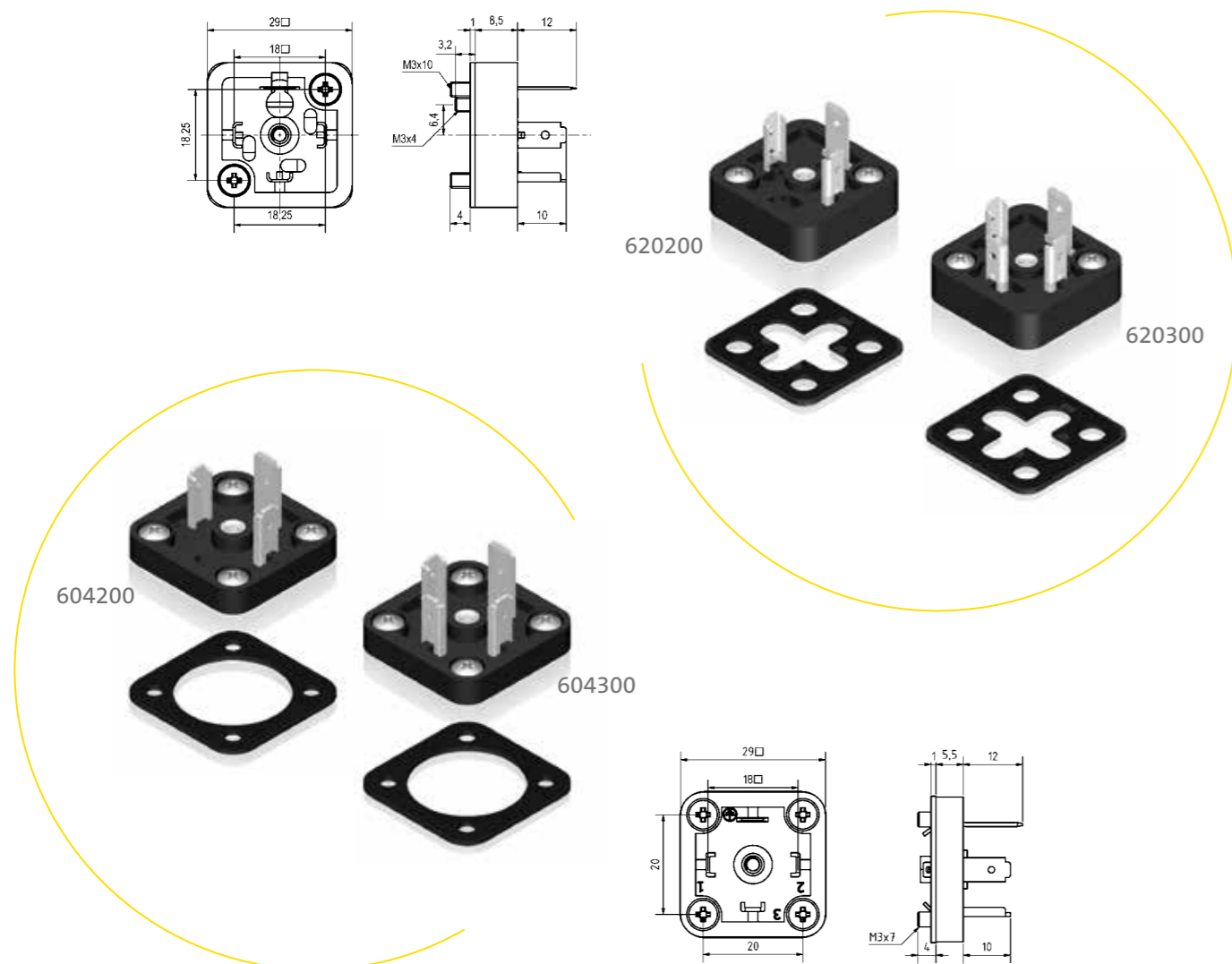

DETAILS

_ DIN 43650/EN 175301-803

_ Contact spacing 18 mm

_ Rated voltage 250 VAC/300 VDC

_ Operating current 10 A

_ Max. current 16 A

_ Max. wire gauge 1,0 mm²

_ Termination solder

_ Housingmaterial PA+30%GF

_ Contact material CuZn (Ag)

_ Temperature range -40 °C to +125 °C

_ 22 mm round collar available

_ Different screw lengths available

_ DIN 43650/EN 175301-803

_ Kontaktabstand 18 mm

_ Nennspannung 250 VAC/300 VDC

_ Dauerstrom 10 A

_ Max. Strom 16 A

_ Max. Leiterquerschnitt 1,0 mm²

_ Anschlussart Löten

_ Gehäusematerial PA+30%GF

_ Kontaktmaterial CuZn (Ag)

_ Temperaturbereich -40 °C bis +125 °C

_ 22 mm Rundkragen verfügbar

_ verschiedene Schraubenlängen verfügbar

BASE CONNECTOR/STIFTPLATTE A

3- OR 4-POLE/3- ODER 4-POLIG, ROUND/RUND

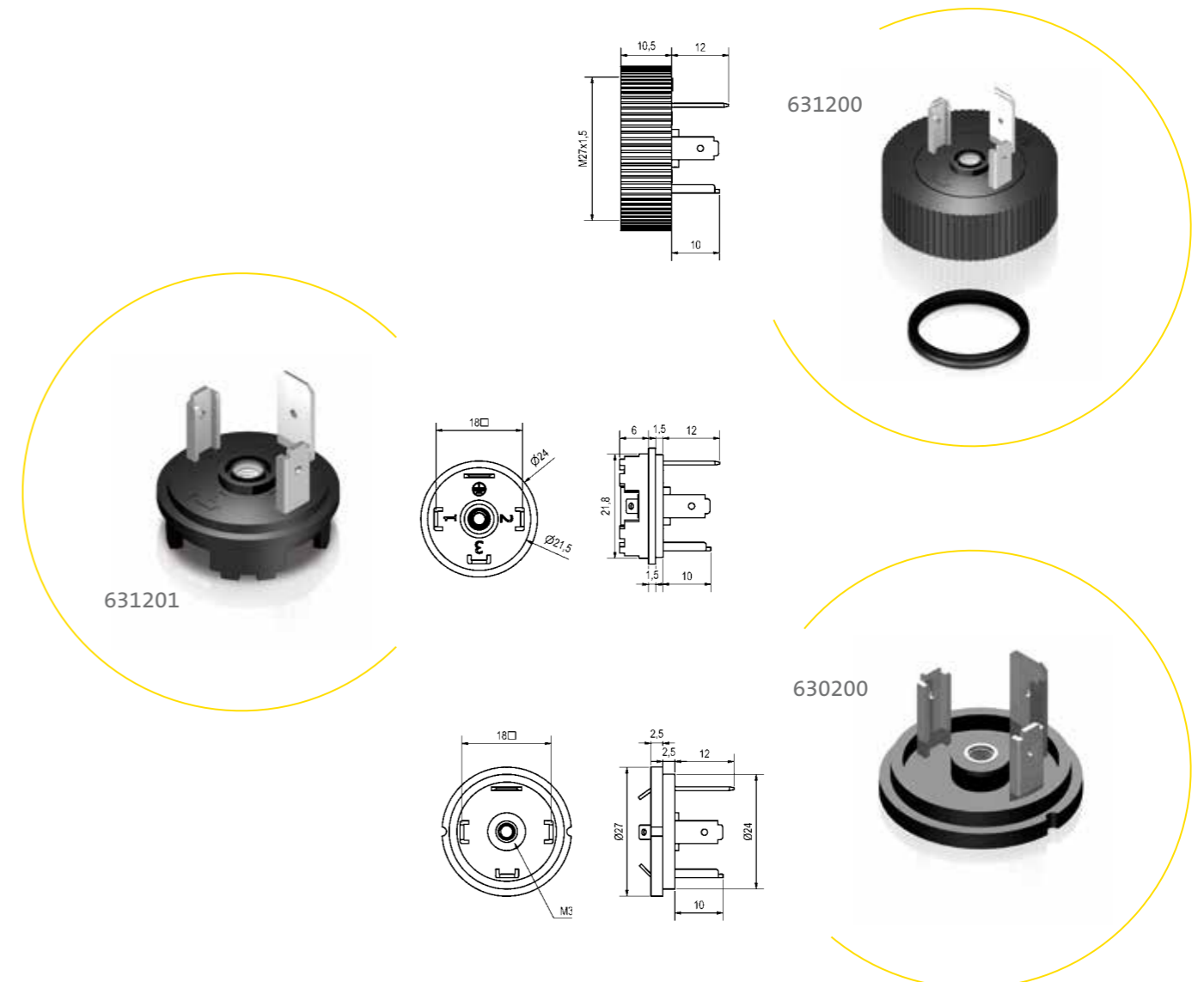

DETAILS

_ DIN 43650/EN 175301-803

_ Contact spacing 18 mm

_ Rated voltage 250 VAC/300 VDC

_ Operating current 10 A

_ Max. current 16 A

_ Max. wire gauge 1,0 mm²

_ Termination solder

_ Housingmaterial PA+30%GF

_ Contact material CuZn (Ag)

_ Temperature range -40 °C to +125 °C

_ With/without lockring available

_ DIN 43650/EN 175301-803

_ Kontaktabstand 18 mm

_ Nennspannung 250 VAC/300 VDC

_ Dauerstrom 10 A

_ Max. Strom 16 A

_ Max. Leiterquerschnitt 1,0 mm²

_ Anschlussart Löten

_ Gehäusematerial PA+30%GF

_ Kontaktmaterial CuZn (Ag)

_ Temperaturbereich -40 °C bis +125 °C

_ Mit/ohne Überwurfmutter verfügbar

BASE CONNECTOR/STIFTPLATTE B

2-POLE + GROUND/2-POLIG + PE

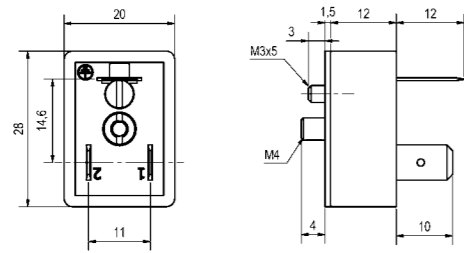

622200

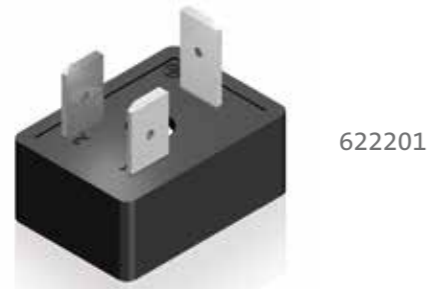

622201

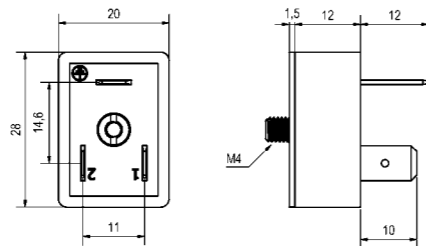

DETAILS

_ Industrial

_ Contact spacing **11 mm**

_ Rated voltage **250 VAC/300 VDC**

_ Operating current **10 A**

_ Max. current **16 A**

_ Max. wire gauge **1,0 mm²**

_ Termination **solder**

_ Housingmaterial **PA+30%GF**

_ Contact material **CuZn (Ag)**

_ Temperature range **-40 °C to +125 °C**

_ **With/without PE-screw** available

_ Industrial

_ Kontaktabstand **11 mm**

_ Nennspannung **250 VAC/300 VDC**

_ Dauerstrom **10 A**

_ Max. Strom **16 A**

_ Max. Leiterquerschnitt **1,0 mm²**

_ Anschlussart **Löten**

_ Gehäusematerial **PA+30%GF**

_ Kontaktmaterial **CuZn (Ag)**

_ Temperaturbereich **-40 °C bis +125 °C**

_ **mit/ohne PE-Schraube** verfügbar

BASE CONNECTOR/STIFTPLATTE C

2- OR 3-POLE/2- ODER 3-POLIG

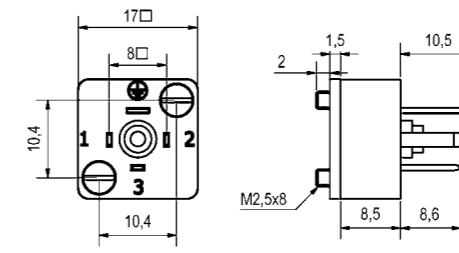

629200

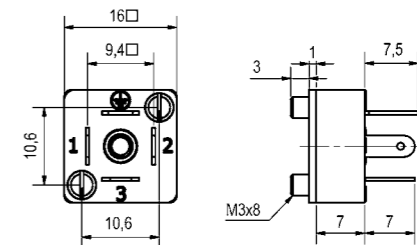

615200

DETAILS

_ Industrial/DIN 43650/EN 175301-803

_ Contact spacing **8 mm (DIN/EN), 9,4 mm (Industrial)**

_ Rated voltage **250VAC/300VDC**

_ Operating current **6A**

_ Max. current **10A**

_ Max. wire gauge **0,75 mm²**

_ Termination **solder**

_ Housingmaterial **PA + 30% GF**

_ Contact material **CuZn (Ag)**

_ Temperature range **-40° C to +125° C**

_ **4-pole** available

_ Industrial/DIN 43650/EN 175301-803

_ Kontaktabstand **8 mm (DIN/EN), 9,4 mm (Industrial)**

_ Nennspannung **250VAC/300VDC**

_ Dauerstrom **6A**

_ Max. Strom **10A**

_ Max. Leiterquerschnitt **0,75 mm²**

_ Anschlussart **Löten**

_ Gehäusematerial **PA + 30% GF**

_ Kontaktmaterial **CuZn (Ag)**

_ Temperaturbereich **-40° C bis +125° C**

_ **4-polig** verfügbar

ORDER CODE/BESTELLNUMMERN

BASE CONNECTOR/STIFTPLATTE A+B+C

BASE CONNECTOR/STIFTPLATTE A, 3- OR 4-POLE/3- ODER 4-POLIG, SQUARE/QUADRATISCH

Contacts/Polzahl	2 + PE	3 + PE	
Mounting Befestigung	Part No. Artikel Nr.	Part No. Artikel Nr.	Special Feature Besonderheit
M3 x 10 mm (2x)	620200	620300	M3 x 4 mm PE-screw/PE-Schraube
M3 x 10 mm (2x)	628200	628300	M3 x 4 mm PE-screw/PE-Schraube
M3 x 10 mm (4x)	626200	626300	M3 x 4 mm PE-screw/PE-Schraube
M3 x 7 mm (4x)	604200	604300	
M3 x 7 mm (4x)	614200	614300	22 mm round collar/Rundkragen

BASE CONNECTOR/STIFTPLATTE A, 3- OR 4-POLE/3- ODER 4-POLIG, ROUND/RUND

Contacts/Polzahl	2 + PE	3 + PE	
Mounting Befestigung	Part No. Artikel Nr.	Part No. Artikel Nr.	Special Feature Besonderheit
Ø 24,5/22 mm	631200	631300	M 27 x 1,5 lockring/Überwurfmutter
Ø 24,5/22 mm	631201	631301	without lockring/ohne Überwurfmutter
Ø 27/24 mm	630200	630300	

BASE CONNECTOR/STIFTPLATTE B, 2-POLE + GROUND/2-POLIG + PE

Contacts/Polzahl	2 + PE	
Mounting Befestigung	Part No. Artikel Nr.	Special Feature Besonderheit
M4 x 15,5 mm	622200	M3 x 5 mm PE-screw/PE-Schraube
M4 x 15,5 mm	622201	without PE-screw/ohne PE-Schraube

BASE CONNECTOR/STIFTPLATTE C, 2- OR 3-POLE/2- ODER 3-POLIG

Contacts/Polzahl	2 + PE	3 + PE	
Mounting Befestigung	Part No. Artikel Nr.	Part No. Artikel Nr.	Contact spacing Kontaktabstand
M2,5 x 8,5 mm	615200	615300	8 mm (DIN/EN)
M3 x 8,5 mm	629200	629300	9,4 mm (Industrial)

NOTES

Grid area for notes.

PRESSURE SWITCH-TRANSMITTER

ALLFLUID -14,5 TO 5800 PSI

DRUCKSCHALTER-TRANSMITTER

ALLFLUID -1 BIS 400 BAR

Pressure switch-Transmitter/Druckschalter-Transmitter
-14,5 to 5800 psi/-1 bis 400 bar



DETAILS

_ Operating voltage **17 to 33 VDC**

_ Current consumption w/o switch. output **max 50mA**

_ Switching current **OUT1/OUT2 250mA/each**

_ Analog output/burden **4...20mA/<500 Ohm**

_ Switchlogic programmable **NO/NC**

_ Switch output **short circuit protection**

_ Electrical connection **M12**

_ Fluid connection
G1/4i external thread (optional adapter)

_ 4-digit LED-display 7-segment **red**

_ Display programmable **0°/180°**

_ Indicator for switch status **LED**

_ Protection class **IP65/67 IEC 60529**

_ Temperature range **-20 °C to +80 °C**

_ Temperature range medium **-20 °C to +80 °C**

_ Wetted material **stainless steel/FPM/ceramic**

_ Overload pressure **3 x FS (max 1500bar)**

_ Linearity **1,0% FS**

_ Temperature sensitivity **±0,65% FS/10K**

_ Dimensions (H x W x D) **80 x 41 x 42mm**

_ Betriebsspannung **17 bis 33 VDC**

_ Stromaufnahme ohne Schaltausgang **max 50mA**

_ Schaltstrom **OUT1/OUT2 je 250mA**

_ Analoger Ausgang/Bürde **4...20mA/<500 Ohm**

_ Schaltlogik programmierbar **NO/NC**

_ Schaltausgänge **kurzschlussfest**

_ Elektroanschluss **M12**

_ Anschluss fluidisch
G1/4i Gewinde (Adapter optional)

_ 4-stellige LED-Anzeige 7-Segment **rot**

_ Anzeige programmierbar **0°/180°**

_ Anzeige für Schaltzustand **LED**

_ Schutzart **IP65/67 IEC 60529**

_ Temperaturbereich **-20 °C bis +80 °C**

_ Medium Temperaturbereich **-20 °C bis +80 °C**

_ Mediumberührende Teile **Edelstahl/FPM/Keramik**

_ Berstdruck **3 x FS (max 1500bar)**

_ Linearität **1,0% FS**

_ Temperaturverhalten **±0,65% FS/10K**

_ Außenabmessung (H x B x T) **80 x 41 x 42mm**

ORDER CODE/BESTELLNUMMERN

PRESSURE SWITCH-TRANSMITTER/

DRUCKSCHALTER-TRANSMITTER

PRESSURE SWITCH-TRANSMITTER/ALLFLUID -14,5 TO 5800 PSI
DRUCKSCHALTER-TRANSMITTER/ALLFLUID -1 BIS 400 BAR



Measuring range	Part No.
Messbereich	Artikel Nr.

- 14,5 to 0 psi/- 1 bis 0 bar	413000
-------------------------------	--------

0 to 232 psi/0 bis 16 bar	413016
---------------------------	--------

0 to 1450 psi/0 bis 100 bar	413100
-----------------------------	--------

0 to 3625 psi/0 bis 250 bar	413250
-----------------------------	--------

0 to 5800 psi/0 bis 400 bar	413400
-----------------------------	--------

Other pressure ranges on request/Andere Druckbereiche auf Anfrage	
---	--

PRESSURE TRANSMITTER-EPT/DEUTSCH DT/58 TO 14500 PSI DRUCKTRANSMITTER-EPT/DEUTSCH DT/4 BIS 1000 BAR

Pressure Transmitter-EPT/Drucktransmitter-EPT/Deutsch DT
58 to 14500 psi/ 4 bis 1000 bar



DETAILS

- _ Operating voltage (0 to 10 V) 15 to 30 VDC
- _ Operating voltage (4 to 20 mA) 10 to 30 VDC
- _ Output short-circuit-proof
- _ Supply voltage reverse polarity protection
- _ Electrical connection Deutsch DT 4 pole
- _ Fluid connection G1/4
- _ Wrench 22 mm
- _ Protection class IP67
- _ Temperature range -40 °C to +105 °C
- _ Temperature range medium -40 °C to +125 °C
- _ Housing stainless steel AISi 304
- _ Wetted material stainless steel AISI 430 F/17-4 PH
- _ Overload pressure see table
- _ Hystere +/-0,15% FS max
- _ Linearity +/-0,25% FS max
- _ Temperature sensitivity (zero point) +/-0,02% FS/C° max
- _ Minimum load for analog output 1000 Ohm (24 V = 600 Ohm) see chart
- _ Shock resistance 100 g/11 msec according to IEC 60068-2-6
- _ Vibration resistance 20 g max at 10...2000 Hz according to IEC 60068-2-6
- _ CE-Conformity according to EC directive 2014/30/EU

- _ Betriebsspannung (0 bis 10 V) 15 bis 30 VDC
- _ Betriebsspannung (4 bis 20 mA) 10 bis 30 VDC
- _ Ausgang kurzschlussfest
- _ Versorgungsspannung verpolungssicher
- _ Elektroanschluss Deutsch DT 4 pol.
- _ Anschluss fluidisch G1/4
- _ Schlüsselweite 22 mm
- _ Schutzart IP67
- _ Temperaturbereich -40 °C bis +105 °C
- _ Medium Temperaturbereich -40 °C bis +125 °C
- _ Gehäuse Edelstahl AISi 304
- _ Mediumberührende Teile Edelstahl AISI 430 F/17-4 PH
- _ Berstdruck siehe Tabelle
- _ Hystere +/-0,15% v. EW max
- _ Linearität +/-0,25% v. EW max
- _ TK-Nullpunkt +/-0,02% v. EW/C° max
- _ Bürde für Analogausgang 1000 Ohm (24 V = 600 Ohm) siehe Diagramm
- _ Schockfestigkeit 100 g/11 msec nach IEC 60068-2-6
- _ Vibrationsfestigkeit 20 g max bei 10...2000 Hz nach IEC 60068-2-6
- _ CE-Konformität gemäß Richtlinie 2014/30/EU

PRESSURE TRANSMITTER-EPT/AMP SUPER SEAL/58 TO 14500 PSI DRUCKTRANSMITTER-EPT/AMP SUPER SEAL/4 BIS 1000 BAR

Pressure Transmitter-EPT/Drucktransmitter-EPT/AMP SUPER SEAL
58 to 14500 psi/ 4 bis 1000 bar



DETAILS

- _ Operating voltage (0 to 10 V) 15 to 30 VDC
- _ Operating voltage (4 to 20 mA) 10 to 30 VDC
- _ Output short-circuit-proof
- _ Supply voltage reverse polarity protection
- _ Electrical connection AMP Super Seal 3 pole
- _ Fluid connection G1/4
- _ Wrench 22 mm
- _ Protection class IP67
- _ Temperature range -40 °C to +105 °C
- _ Temperature range medium -40 °C to +125 °C
- _ Housing stainless steel AISi 304
- _ Wetted material stainless steel AISI 430 F/17-4 PH
- _ Overload pressure see table
- _ Hystere +/-0,15% FS max
- _ Linearity +/-0,25% FS max
- _ Temperature sensitivity (zero point) +/-0,02% FS/C° max
- _ Minimum load for analog output 1000 Ohm (24 V = 600 Ohm) see chart
- _ Shock resistance 100 g/11 msec according to IEC 60068-2-6
- _ Vibration resistance 20 g max at 10...2000 Hz according to IEC 60068-2-6
- _ CE-Conformity according to EC directive 2014/30/EU

- _ Betriebsspannung (0 bis 10 V) 15 bis 30 VDC
- _ Betriebsspannung (4 bis 20 mA) 10 bis 30 VDC
- _ Ausgang kurzschlussfest
- _ Versorgungsspannung verpolungssicher
- _ Elektroanschluss AMP Super Seal 3 pol.
- _ Anschluss fluidisch G1/4
- _ Schlüsselweite 22 mm
- _ Schutzart IP67
- _ Temperaturbereich -40 °C bis +105 °C
- _ Medium Temperaturbereich -40 °C bis +125 °C
- _ Gehäuse Edelstahl AISi 304
- _ Mediumberührende Teile Edelstahl AISI 430 F/17-4 PH
- _ Berstdruck siehe Tabelle
- _ Hystere +/-0,15% v. EW max
- _ Linearität +/-0,25% v. EW max
- _ TK-Nullpunkt +/-0,02% v. EW/C° max
- _ Bürde für Analogausgang 1000 Ohm (24 V = 600 Ohm) siehe Diagramm
- _ Schockfestigkeit 100 g/11 msec nach IEC 60068-2-6
- _ Vibrationsfestigkeit 20 g max bei 10...2000 Hz nach IEC 60068-2-6
- _ CE-Konformität gemäß Richtlinie 2014/30/EU

PRESSURE TRANSMITTER-EPT/ DIN EN 175301-803/58 TO 14500 PSI

DRUCKTRANSMITTER-EPT/DIN EN 175301-803/4 BIS 1000 BAR

Pressure Transmitter-EPT/ Drucktransmitter-EPT/DIN EN 175301-803
58 to 14500 psi/ 4 bis 1000 bar



DETAILS

_ Operating voltage (0 to 10 V) 15 to 30 VDC

_ Operating voltage (4 to 20 mA) 10 to 30 VDC

_ Output short-circuit-proof

_ Supply voltage reverse polarity protection

_ Electrical connection DIN EN 175301-803

_ Fluid connection G1/4

_ Wrench 22 mm

_ Protection class IP65

_ Temperature range -40 °C to +105 °C

_ Temperature range medium -40 °C to +125 °C

_ Housing stainless steel AISi 304

_ Wetted material stainless steel AISI 430 F/17-4 PH

_ Overload pressure see table

_ Hystere +/-0,15% FS max

_ Linearity +/-0,25% FS max

_ Temperature sensitivity (zero point)
+/-0,02% FS/C° max

_ Minimum load for analog output
1000 Ohm (24 V = 600 Ohm) see chart

_ Shock resistance
100 g/11 msec according to IEC 60068-2-6

_ Vibration resistance
20 g max at 10...2000 Hz according to IEC 60068-2-6

_ CE-Conformity according to EC directive 2014/30/EU

_ Betriebsspannung (0 bis 10 V) 15 bis 30 VDC

_ Betriebsspannung (4 bis 20 mA) 10 bis 30 VDC

_ Ausgang kurzschlussfest

_ Versorgungsspannung verpolungssicher

_ Elektroanschluss DIN EN 175301-803

_ Anschluss fluidisch G1/4

_ Schlüsselweite 22 mm

_ Schutzart IP65

_ Temperaturbereich -40 °C bis +105 °C

_ Medium Temperaturbereich -40 °C bis +125 °C

_ Gehäuse Edelstahl AISi 304

_ Mediumberührende Teile Edelstahl AISI 430 F/17-4 PH

_ Berstdruck siehe Tabelle

_ Hystere +/-0,15% v. EW max

_ Linearität +/-0,25% v. EW max

_ TK-Nullpunkt
+/-0,02% v. EW/C° max

_ Bürde für Analogausgang
1000 Ohm (24 V = 600 Ohm) siehe Diagramm

_ Schockfestigkeit
100 g/11 msec nach IEC 60068-2-6

_ Vibrationsfestigkeit
20 g max bei 10...2000 Hz nach IEC 60068-2-6

_ CE-Konformität gemäß Richtlinie 2014/30/EU

PRESSURE TRANSMITTER-EPT/M12/58 TO 14500 PSI

DRUCKTRANSMITTER-EPT/M12/4 BIS 1000 BAR

Pressure Transmitter-EPT/ Drucktransmitter-EPT/M12
58 to 14500 psi/ 4 bis 1000 bar



DETAILS

_ Operating voltage (0 to 10 V) 15 to 30 VDC

_ Operating voltage (4 to 20 mA) 10 to 30 VDC

_ Output short-circuit-proof

_ Supply voltage reverse polarity protection

_ Electrical connection M12

_ Fluid connection G1/4

_ Wrench 22 mm

_ Protection class IP67

_ Temperature range -40 °C to +105 °C

_ Temperature range medium -40 °C to +125 °C

_ Housing stainless steel AISi 304

_ Wetted material stainless steel AISI 430 F/17-4 PH

_ Overload pressure see table

_ Hystere +/-0,15% FS max

_ Linearity +/-0,25% FS max

_ Temperature sensitivity (zero point)
+/-0,02% FS/C° max

_ Minimum load for analog output
1000 Ohm (24 V = 600 Ohm) see chart

_ Shock resistance
100 g/11 msec according to IEC 60068-2-6

_ Vibration resistance
20 g max at 10...2000 Hz according to IEC 60068-2-6

_ CE-Conformity according to EC directive 2014/30/EU

_ Betriebsspannung (0 bis 10 V) 15 bis 30 VDC

_ Betriebsspannung (4 bis 20 mA) 10 bis 30 VDC

_ Ausgang kurzschlussfest

_ Versorgungsspannung verpolungssicher

_ Elektroanschluss M12

_ Anschluss fluidisch G1/4

_ Schlüsselweite 22 mm

_ Schutzart IP67

_ Temperaturbereich -40 °C bis +105 °C

_ Medium Temperaturbereich -40 °C bis +125 °C

_ Gehäuse Edelstahl AISi 304

_ Mediumberührende Teile Edelstahl AISI 430 F/17-4 PH

_ Berstdruck siehe Tabelle

_ Hystere +/-0,15% v. EW max

_ Linearität +/-0,25% v. EW max

_ TK-Nullpunkt
+/-0,02% v. EW/C° max

_ Bürde für Analogausgang
1000 Ohm (24 V = 600 Ohm) siehe Diagramm

_ Schockfestigkeit
100 g/11 msec nach IEC 60068-2-6

_ Vibrationsfestigkeit
20 g max bei 10...2000 Hz nach IEC 60068-2-6

_ CE-Konformität gemäß Richtlinie 2014/30/EU

PRESSURE RANGES

MESSEBEREICHE

RANGE (BAR) MESSBEREICHE (BAR)	4	6	10	16	20	25	40	60	100	160	200	250	400	600	1000
OVERPRESSURE (BAR) ÜBERDRUCK (BAR)	8	12	20	32	40	50	80	120	200	320	400	500	800	1200	1200
BURST PRESSURE (BAR) BERSTDRUCK (BAR)	16	24	40	64	80	100	160	240	400	640	800	1000	1500	1500	1500

ELECTRICAL CONNECTION/CONNECTION DIAGRAMS

ELEKTRISCHE ANSCHLÜSSE/ANSCHLUSSBILDER

VOLTAGE AMPLIFIED OUTPUT VERSTÄRKTER SPANNUNGS AUSGANG

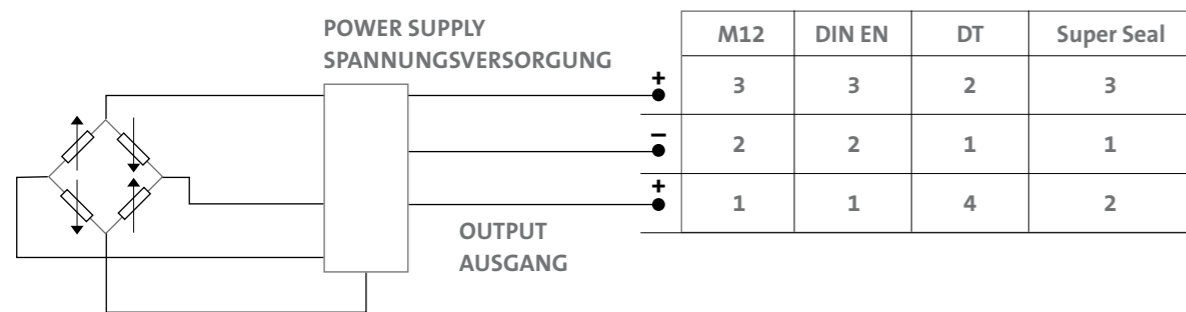

CURRENT AMPLIFIED OUTPUT VERSTÄRKTER STROMAUSGANG

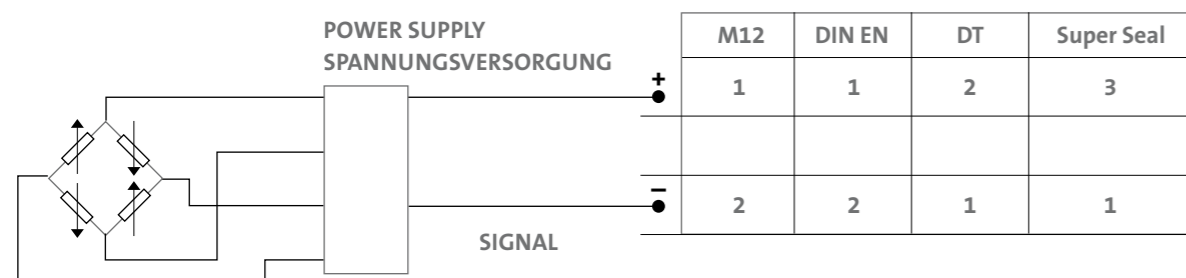

LOAD DIAGRAM

LASTDIAGRAMM

CURRENT OUTPUT STROMAUSGANG

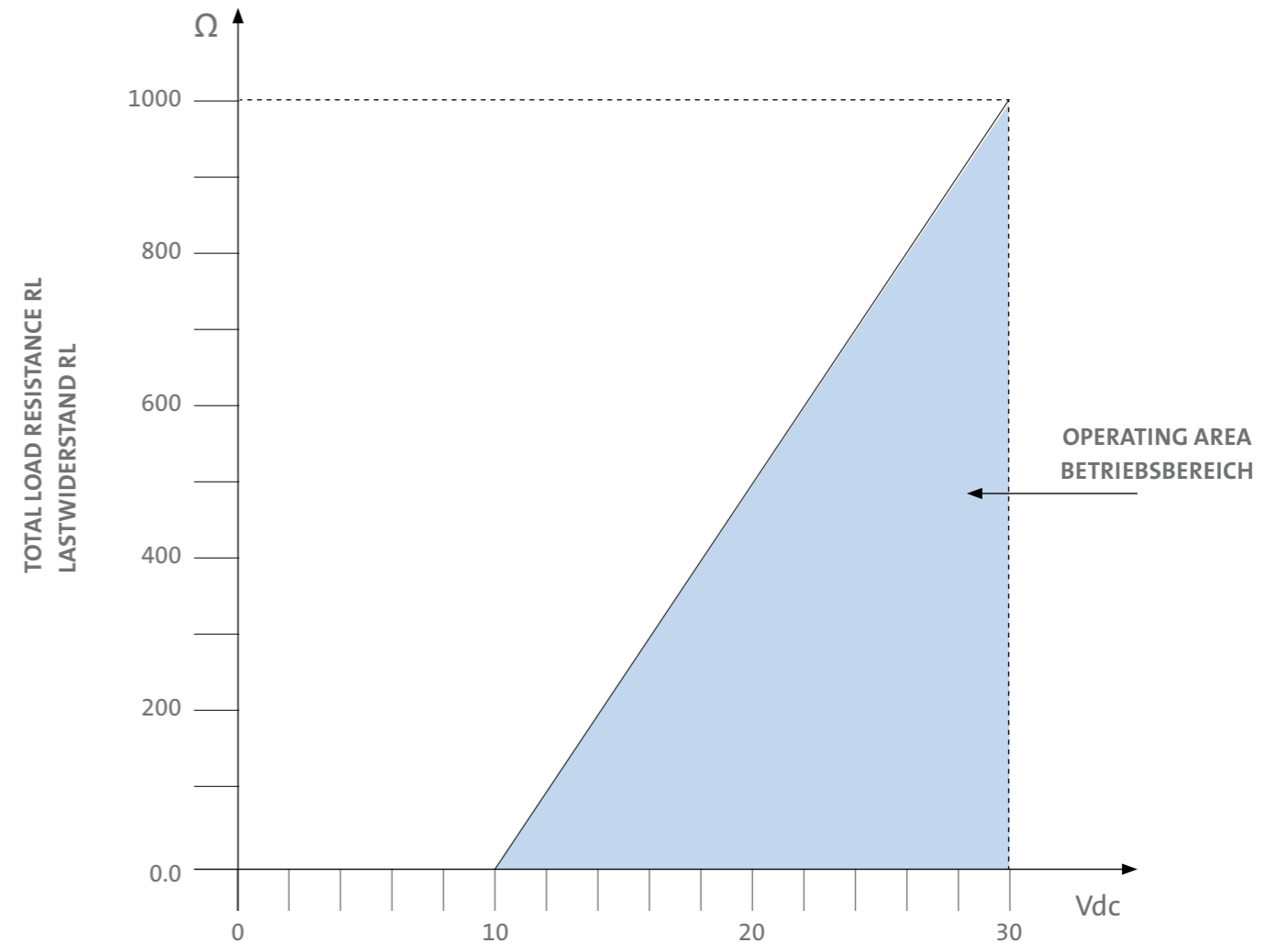

POWER SUPPLY VOLTAGE
VERSORGUNGSSPANNUNG
 $RL = (V \text{ SUPPLY} - 10 \text{ V}) / 0.02 \text{ A}$

ORDER CODE/BESTELLNUMMERN

PRESSURE SWITCH/DRUCKSCHALTER (S. 32 – 35)

PRESSURE TRANSMITTER-EPT/DEUTSCH DT/0 TO 5800 PSI DRUCKTRANSMITTER-EPT/DEUTSCH DT/4 BIS 1000 BAR



Measuring range Messbereich	Part No. Artikel Nr.
58 to 232 psi/4 bis 16 bar	434016
58 to 580 psi/4 bis 40 bar	434040
58 to 1450 psi/4 bis 100 bar	434100
58 to 3625 psi/4 bis 250 bar	434250
58 to 5800 psi/4 bis 400 bar	434400
58 to 8700 psi/4 bis 600 bar	434600
58 to 14500 psi/4 bis 1000 bar	434999

PRESSURE TRANSMITTER-EPT/AMP SUPER SEAL/0 TO 5800 PSI DRUCKTRANSMITTER-EPT/AMP SUPER SEAL/4 BIS 1000 BAR



Measuring range Messbereich	Part No. Artikel Nr.
58 to 232 psi/4 bis 16 bar	436016
58 to 580 psi/4 bis 40 bar	436040
58 to 1450 psi/4 bis 100 bar	436100
58 to 3625 psi/4 bis 250 bar	436250
58 to 5800 psi/4 bis 400 bar	436400
58 to 8700 psi/4 bis 600 bar	436600
58 to 14500 psi/4 bis 1000 bar	436999

PRESSURE TRANSMITTER-EPT/DIN EN 175301-803/0 TO 5800 PSI DRUCKTRANSMITTER-EPT/DIN EN 175301-803/4 BIS 1000 BAR



Measuring range Messbereich	Part No. Artikel Nr.
58 to 232 psi/4 bis 16 bar	435016
58 to 580 psi/4 bis 40 bar	435040
58 to 1450 psi/4 bis 100 bar	435100
58 to 3625 psi/4 bis 250 bar	435250
58 to 5800 psi/4 bis 400 bar	435400
58 to 8700 psi/4 bis 600 bar	435600
58 to 14500 psi/4 bis 1000 bar	435999

PRESSURE TRANSMITTER-EPT/M12/0 TO 5800 PSI DRUCKTRANSMITTER-EPT/M12/4 BIS 1000 BAR



Measuring range Messbereich	Part No. Artikel Nr.
58 to 232 psi/4 bis 16 bar	432016
58 to 580 psi/4 bis 40 bar	432040
58 to 1450 psi/4 bis 100 bar	432100
58 to 3625 psi/4 bis 250 bar	432250
58 to 5800 psi/4 bis 400 bar	432400
58 to 8700 psi/4 bis 600 bar	432600
58 to 14500 psi/4 bis 1000 bar	432999

PRESSURE SWITCH-MECHANICAL/PBS/PNEUMATIC TO 232 PSI DRUCKSCHALTER-MECHANISCH/PBS/PNEUMATISCH BIS 16 BAR

Pressure Switch-/ Druckschalter-mechanical
PBS/Pneumatic to 232 PSI/Pneumatisch bis 16 bar

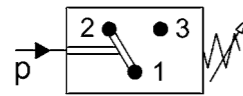
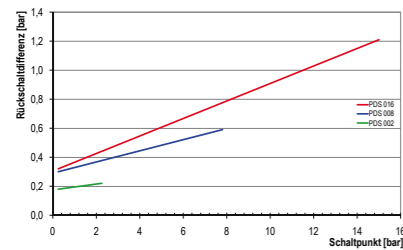

DETAILS

- _ Operating fluid **Neutral gaseous and liquid fluids**
- _ Mounting method **2 x drill-hole Ø 5,2 mm**
- _ Fluid connection
G1/4" female thread , NPT 1/4" or flange
- _ Environmental temperature **-10 °C to +80 °C**
- _ Maximum pressure **290 psi**
- _ Operating pressure range **0,2 to 2/0,5 to 8/1 to 16 bar**
- _ Repeatability **< 2% of max. pressure range FS**
- _ Differential reset **see diagram**
- _ Max. switching frequency **200/min**
- _ Vibration resistance **10 g (10 to 2000 Hz)**
- _ Shock resistance **30 g**
- _ Electrical connection **DIN 43650-A (EN 175301-803)**
- _ Switching element **toggle switch with control unit**
- _ Operating cycles **> 2 x 10⁶**
- _ Operating voltage/current
AC 12: 4 A/250 VAC ; AC14: 1 A/250 VAC
DC 12: 3 A/28 VDC ; DC14: 4 A/28 VDC
- _ Degree of protection **IP65**
- _ Material **Housing: Pressure die-cast, knob: Alu**
- _ Seals **Perbunan**
- _ Weight **~ 0,295 kg**

- _ Betriebsfluid **Druckluft, 50 µm gefiltert**
- _ Befestigungsart **2 x Bohrung im Gehäuse, Ø 5,2 mm**
- _ Anschluss **fluidisch**
Innengewinde G1/4", NPT 1/4", Flansch
- _ Umgebungstemperatur **-10 °C bis +80 °C**
- _ Betriebsdruck **max. 20 bar**
- _ Druckeinstellbereich **0,2 bis 2/0,5 bis 8/1 bis 16 bar**
- _ Wiederholgenauigkeit **< 2% Bereichsendwert bezogen**
- _ Rückschaltdifferenz **s. Diagramm Rückschaltdifferenz**
- _ Max. Schalthäufigkeit **200/min**
- _ Vibrationsfestigkeit **10 g (10 bis 2000 Hz)**
- _ Schockfestigkeit **30 g**
- _ Anschluss elektrisch **DIN 43650-A (EN 175301-803)**
- _ Schaltelement **Wechselschalter mit Schaltwerk**
- _ Lebensdauer **> 2 x 10⁶**
- _ Betriebsstrom/-spannung
AC 12: 4 A/250 VAC ; AC14: 1 A/250 VAC
DC 12: 3 A/28 VDC ; DC14: 4 A/28 VDC
- _ Schutzart nach **EN 60529 IP65**
- _ Material **Gehäuse: Zinkdruckguss, Knopf: Alu**
- _ Dichtungen **Perbunan**
- _ Masse **~ 0,295 kg**

PRESSURE SWITCH-MECHANICAL/HDS/HYDRAULIC TO 5800 PSI DRUCKSCHALTER-MECHANISCH/HDS/HYDRAULIK BIS 400 BAR

Pressure Switch-/ Druckschalter-mechanical
HDS/Hydraulic to 5800 psi/Hydraulik bis 400 bar

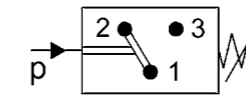
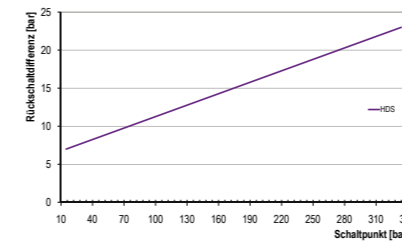

DETAILS

- _ Operating fluid **self-lubricating fluid**
- _ Fluid connection
G1/4" optional flange DIN ISO 16873
- _ Environmental temperature **-30 °C to +80 °C**
- _ Fluid temperature **max. +80 °C**
- _ Maximum pressure
5075 psi (flange horizontal 3625 bar)
- _ Cracking pressure **> 8700 psi**
- _ Operating pressure range
10-30; 10-80; 10-120; 20-200; 20-320 bar
- _ Repeatability **< 2% of max. pressure range FS**
- _ Differential reset **see diagram**
- _ Vibration resistance **10 g (10 to 2000 Hz)**
- _ Shock resistance **30 g**
- _ Electrical connection **DIN 43650-A (EN 175301-803)**
- _ Switching element **toggle switch with control unit**
- _ Operating cycles **> 2 x 10⁶**
- _ Operating voltage/current
AC 12: 4 A/250 VAC ; AC14: 1 A/250 VAC
DC 12: 3 A/28 VDC ; DC14: 4 A/28 VDC
- _ Degree of protection **IP65**
- _ Material **Housing: Pressure die-cast, knob: Alu**
- _ Seals **dynamic: PTFE; static: NBR**
- _ Weight **~ 0,325 kg**

- _ Betriebsfluid **selbstschmierende Fluide**
- _ Anschluss **fluidisch**
G1/4" optional Flansch DIN ISO 16873
- _ Umgebungstemperatur **-30 °C bis +80 °C**
- _ Fluidtemperatur **max. +80 °C**
- _ Betriebsdruck **max.**
350 bar (Flansch horizontal 250 bar)
- _ Berstdruck **max. > 600 bar**
- _ Druckeinstellbereich
10-30; 10-80; 10-120; 20-200; 20-320 bar
- _ Wiederholgenauigkeit **< 2% Bereichsendwert bezogen**
- _ Rückschaltdifferenz **s. Diagramm Rückschaltdifferenz**
- _ Vibrationsfestigkeit **10 g (10 bis 2000 Hz)**
- _ Schockfestigkeit **30 g**
- _ Anschluss elektrisch **DIN 43650-A (EN 175301-803)**
- _ Schaltelement **Wechselschalter mit Schaltwerk**
- _ Lebensdauer **> 2 x 10⁶**
- _ Betriebsstrom/-spannung
AC 12: 4 A/250 VAC ; AC14: 1 A/250 VAC
DC 12: 3 A/28 VDC ; DC14: 4 A/28 VDC
- _ Schutzart nach **EN 60529 IP65**
- _ Material **Gehäuse: Zinkdruckguss, Knopf: Alu**
- _ Dichtungen **dynamisch: PTFE; statisch: NBR**
- _ Masse **~ 0,325 kg**

PRESSURE SWITCH PDC – ADJUSTABLE HYSTERISIS

PNEUMATIC TO 232 PSI

DRUCKSCHALTER PDC – HYSTERESE EINSTELLBAR

PNEUMATISCH BIS 16 BAR

Pressure Switch PDC/ Druckschalter-mechanical PDC
Pneumatic to 232 PSI/Pneumatisch bis 16 bar

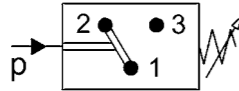
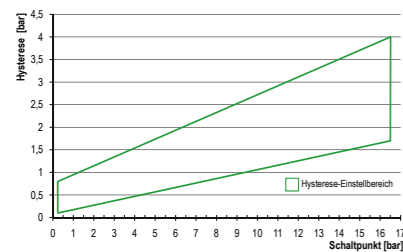

PRESSURE SWITCH HDC – ADJUSTABLE HYSTERISIS

HYDRAULIC TO 4640 PSI

DRUCKSCHALTER HDC – HYSTERESE EINSTELLBAR

HYDRAULIK BIS 320 BAR

Pressure Switch HDC/ Druckschalter-mechanical HDC
Hydraulic to 4640 psi/Hydraulik bis 320 bar

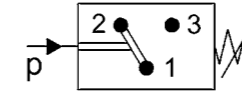
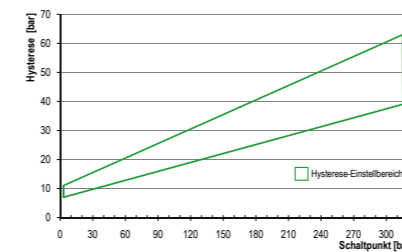

DETAILS

_ Operating fluid **Neutral gaseous and liquid fluids**

_ Fluid connection **G1/4"**

_ Environmental temperature **-20 °C to +80 °C**

_ Fluid temperature **max. +80 °C**

_ Maximum pressure **870 psi**

_ Operating pressure range **0,2 to 2/0,5 to 8/1 to 16 bar**

_ Repeatability **< 2% of max. pressure range FS**

_ Differential reset **see diagram**

_ Vibration resistance **10 g (10 to 2000 Hz)**

_ Shock resistance **30 g**

_ Electrical connection **DIN 43650-A (EN 175301-803)**

_ Switching element **toggle switch**

_ Operating voltage/current

AC 12: 4 A/250 VAC; AC14: 1 A/250 VAC

DC 12: 2 A/28 VDC; DC14: 0,5 A/28 VDC

_ Degree of protection **IP65**

_ Material **Housing: galvanized steel**

_ Seals **dynamic: PTFE; static: NBR**

_ Weight **~ 0,1 kg**

_ Betriebsfluid **Druckluft, neutrale Fluide**

_ Anschluss fluidisch **G1/4"**

_ Umgebungstemperatur **-20 °C bis +80 °C**

_ Fluidtemperatur **max. +80 °C**

_ Betriebsdruck **max. 60 bar**

_ Druckeinstellbereich **0,2 bis 2/0,5 bis 8/1 bis 16 bar**

_ Wiederholgenauigkeit **< 2% Bereichsendwert bezogen**

_ Rückschaltdifferenz **s. Diagramm Rückschaltdifferenz**

_ Vibrationsfestigkeit **10 g (10 bis 2000 Hz)**

_ Schockfestigkeit **30 g**

_ Anschluss elektrisch **DIN 43650-A (EN 175301-803)**

_ Schaltelement **Wechselschalter**

_ Betriebsstrom/-spannung

AC 12: 4 A/250 VAC; AC14: 1 A/250 VAC

DC 12: 2 A/28 VDC; DC14: 0,5 A/28 VDC

_ Schutzart nach **EN 60529 IP65**

_ Material **Gehäuse: Stahl verzinkt**

_ Dichtungen **dynamisch: PTFE; statisch: NBR**

_ Masse **~ 0,1 kg**

DETAILS

_ Operating fluid **self-lubricating fluid**

_ Fluid connection **G1/4"**

_ Environmental temperature **-20 °C to +80 °C**

_ Fluid temperature **max. +80 °C**

_ Maximum pressure **5075 psi**

_ Operating pressure range

10 to 80; 10 to 120; 20 to 250; 20 to 320 bar

_ Repeatability **< 2% of max. pressure range FS**

_ Differential reset **see diagram**

_ Vibration resistance **10 g (10 to 2000 Hz)**

_ Shock resistance **30 g**

_ Electrical connection **DIN 43650-A (EN 175301-803)**

_ Switching element **toggle switch**

_ Operating voltage/current

AC 12: 4 A/250 VAC; AC14: 1 A/250 VAC

DC 12: 2 A/28 VDC; DC14: 0,5 A/28 VDC

_ Degree of protection **IP65**

_ Material **Housing: galvanized steel**

_ Seals **dynamic: PTFE; static: NBR**

_ Weight **~ 0,1 kg**

_ Betriebsfluid **selbstschmierende Fluidee**

_ Anschluss fluidisch **G1/4"**

_ Umgebungstemperatur **-20 °C bis +80 °C**

_ Fluidtemperatur **max. +80 °C**

_ Betriebsdruck **max. 350 bar**

_ Druckeinstellbereich

10 to 80; 10 to 120; 20 to 250; 20 to 320 bar

_ Wiederholgenauigkeit **< 2% Bereichsendwert bezogen**

_ Rückschaltdifferenz **s. Diagramm Rückschaltdifferenz**

_ Vibrationsfestigkeit **10 g (10 bis 2000 Hz)**

_ Schockfestigkeit **30 g**

_ Anschluss elektrisch **DIN 43650-A (EN 175301-803)**

_ Schaltelement **Wechselschalter**

_ Betriebsstrom/-spannung

AC 12: 4 A/250 VAC; AC14: 1 A/250 VAC

DC 12: 2 A/28 VDC; DC14: 0,5 A/28 VDC

_ Schutzart nach **EN 60529 IP65**

_ Material **Gehäuse: Stahl verzinkt**

_ Dichtungen **dynamisch: PTFE; statisch: NBR**

_ Masse **~ 0,1 kg**

PRESSURE SWITCH DL/PNEUMATIC TO 232 PSI

DRUCKSCHALTER DL/PNEUMATISCH BIS 16 BAR

Pressure Switch DL/ Druckschalter DL
Pneumatic to 232 PSI/Pneumatisch bis 16 bar

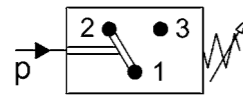
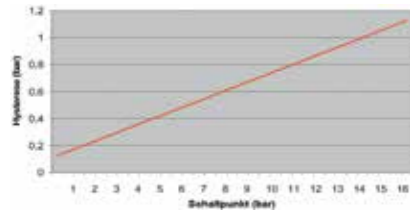

DETAILS

_ Operating fluid Neutral gaseous and liquid fluids	_ Betriebsfluid Druckluft, neutrale Fluide
_ Fluid connection G1/4"	_ Anschluss fluidisch G1/4"
_ Environmental temperature -20 °C to +80 °C	_ Umgebungstemperatur -20 °C bis +80 °C
_ Fluid temperature max. +80 °C	_ Fluidtemperatur max. +80 °C
_ Maximum pressure 870 psi	_ Betriebsdruck max. 60 bar
_ Operating pressure range -0,85 to 1/0,2 to 2/0,5 to 8/1 to 16 bar	_ Druckeinstellbereich -0,85 bis 1/0,2 bis 2/0,5 bis 8/1 bis 16 bar
_ Repeatability < 2% of max. pressure range FS	_ Wiederholgenauigkeit < 2% Bereichsendwert bezogen
_ Differential reset see diagram	_ Rückschaltdifferenz s. Diagramm Rückschaltdifferenz
_ Vibration resistance 10 g (10 to 2000 Hz)	_ Vibrationsfestigkeit 10 g (10 bis 2000 Hz)
_ Shock resistance 30 g	_ Schockfestigkeit 30 g
_ Electrical connection M12 (DIN IEC 61076-2-101)	_ Anschluss elektrisch M12 (DIN IEC 61076-2-101)
_ Switching element toggle switch	_ Schaltelement Wechselschalter
_ Operating voltage/current AC 12: 4 A/50 VAC; AC14: 1 A/50 VAC DC 12: 2 A/28 VDC; DC14: 0,5 A/28 VDC	_ Betriebsstrom/-spannung AC 12: 4 A/50 VAC; AC14: 1 A/50 VAC DC 12: 2 A/28 VDC; DC14: 0,5 A/28 VDC
_ Degree of protection IP68	_ Schutzart nach EN 60529 IP68
_ Material Housing: galvanized steel	_ Material Gehäuse: Stahl verzinkt
_ Seals Perbunan	_ Dichtungen/Membrane Perbunan
_ Weight ~ 0,1 kg	_ Masse ~ 0,1 kg

NOTES

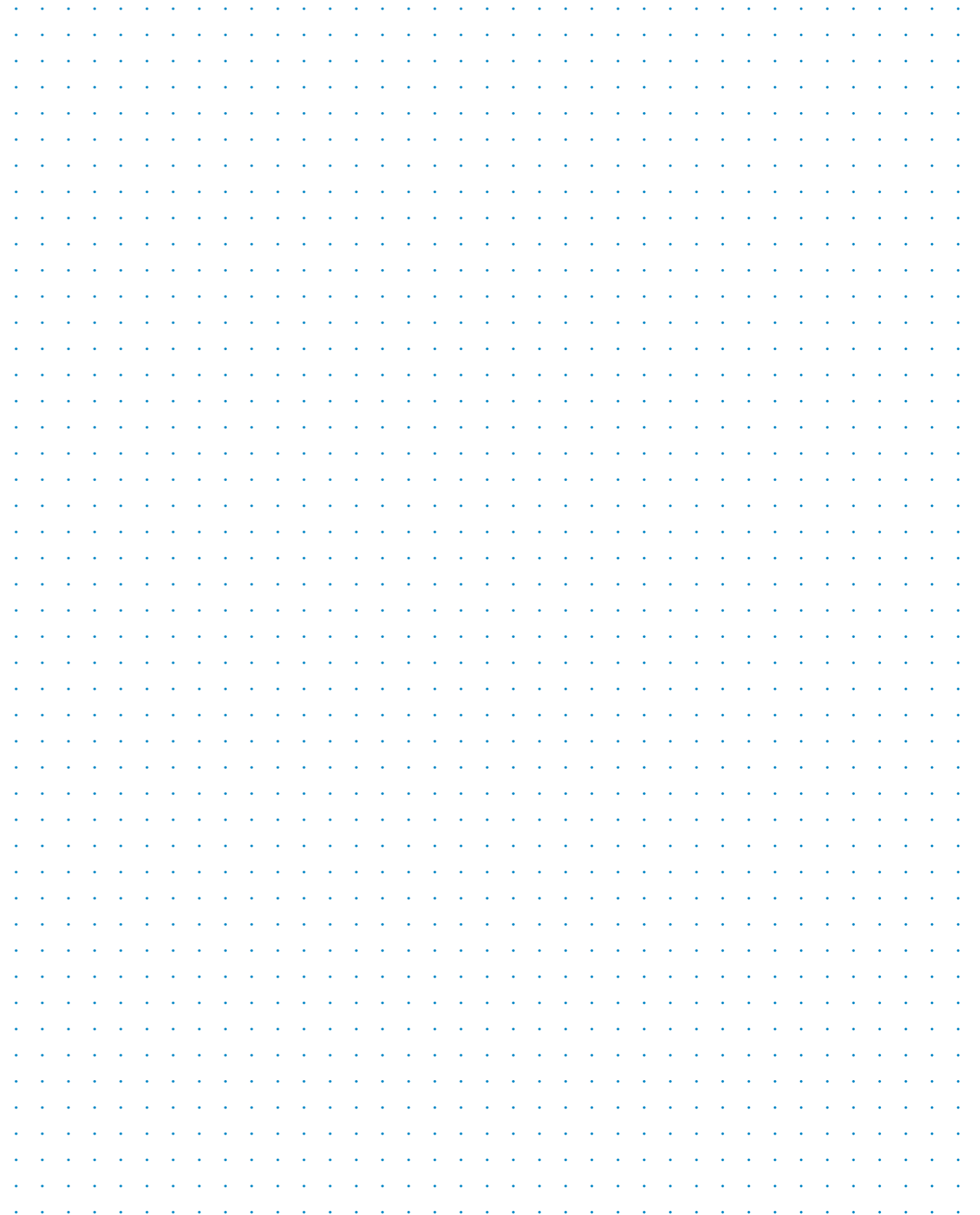

ORDER CODE/BESTELLNUMMERN

PRESSURE SWITCH/DRUCKSCHALTER (S. 40 – 44)

PRESSURE SWITCH-MECHANICAL/PBS/PNEUMATIC TO 232 PSI DRUCKSCHALTER-MECHANISCH/PBS/PNEUMATISCH BIS 16 BAR



Pressure adjustment range Druckeinstellbereich	Part No. Artikel Nr.
7 to 116 psi/0,5 bis 8 bar	451208
14,5 to 232 psi/1 bis 16 bar	451216

Other pressure ranges on request/Andere Druckbereiche auf Anfrage

PRESSURE SWITCH-MECHANICAL/HDS/HYDRAULIC TO 5800 PSI DRUCKSCHALTER-MECHANISCH/HDS/HYDRAULIK BIS 400 BAR



Pressure adjustment range Druckeinstellbereich	Part No. Artikel Nr.
145 to 1160 psi/10 bis 80 bar	452708
145 to 1740 psi/10 bis 120 bar	452712
290 to 2900 psi/20 bis 200 bar	452720
290 to 4640 psi/20 bis 320 bar	452732

Other pressure ranges on request/Andere Druckbereiche auf Anfrage

PRESSURE SWITCH PDC – ADJUSTABLE HYSTERISIS/PNEUMATIC TO 232 PSI DRUCKSCHALTER PDC – HYSTERESE EINSTELLBAR/PNEUMATISCH BIS 16 BAR



Measuring range Messbereich	Part No. Artikel Nr.
3 to 29 psi/0,2 bis 2 bar	453302
7 to 116 psi/0,5 bis 8 bar	453308
14,5 to 232 psi/1 bis 16 bar	453316

Other pressure ranges on request/Andere Druckbereiche auf Anfrage

PRESSURE SWITCH HDC – ADJUSTABLE HYSTERISIS/HYDRAULIC TO 4640 PSI DRUCKSCHALTER HDC – HYSTERESE EINSTELLBAR/HYDRAULIK BIS 320 BAR



Pressure adjustment range Druckeinstellbereich	Part No. Artikel Nr.
145 to 1160 psi/10 bis 80 bar	454308
145 to 1740 psi/10 bis 120 bar	454312
290 to 2900 psi/20 bis 200 bar	454320
290 to 4640 psi/20 bis 320 bar	454332

Other pressure ranges on request/Andere Druckbereiche auf Anfrage

PRESSURE SWITCH DL/PNEUMATIC TO 232 PSI DRUCKSCHALTER DL/PNEUMATISCH BIS 16 BAR



Measuring range Messbereich	Part No. Artikel Nr.
- 12 to 14,5 psi/- 0,85 bis 1 bar	455301
3 to 29 psi/0,2 bis 2 bar	455302
7 to 116 psi/0,5 bis 8 bar	455308
14,5 to 232 psi/1 bis 16 bar	455316

Other pressure ranges on request/Andere Druckbereiche auf Anfrage

VALVE TIMER/VENTIL TIMER FORM/BAUFORM A · B-IND.



991260



990720

DETAILS

- _ Contact spacing **991260: 11 mm, 990720: 18 mm**
- _ Rated voltage **24–240 VAC/DC**
- _ Operating current **1 A**
- _ On time **990720: 0,5-10s, 991260: 2s**
- _ Off time
990720: 0,5-45 min, 991260: 0,5-120 min
- _ Operating indicator **LED yellow**
- _ Protection class **IP65**
- _ Temperature range **–30 °C to +60 °C**

- _ Kontaktabstand **991260: 11 mm, 990720: 18 mm**
- _ Nennspannung **24–240 VAC/DC**
- _ Dauerstrom **1 A**
- _ Einschaltdauer **990720: 0,5-10s, 991260: 2s**
- _ Ausschaltdauer
990720: 0,5-45 min, 991260: 0,5-120 min
- _ Statusanzeige **LED gelb**
- _ Schutzart **IP65**
- _ Temperaturbereich **–30 °C bis +60 °C**

LIGHT GASKET/LEUCHTDICHTUNG FORM/BAUFORM A · B

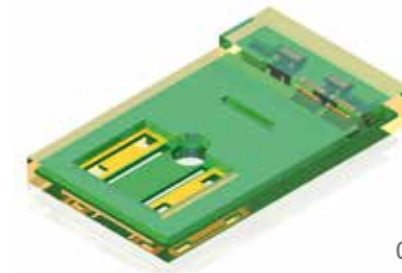

018027

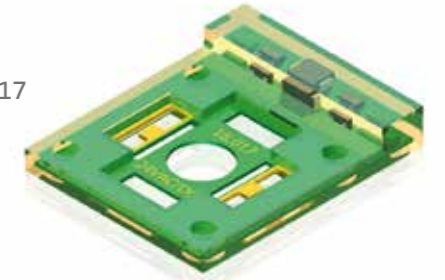

018017

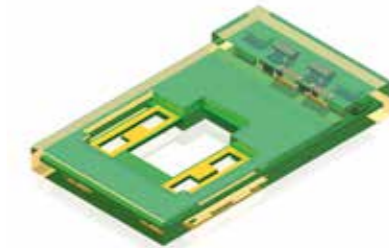

018037

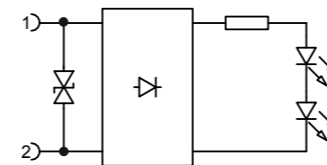

DETAILS

- _ Contact spacing form A **18 mm**
- _ Contact spacing form B/Ind. **11 mm**
- _ Contact spacing form B/DIN **10 mm**
- _ Rated voltage **24 VAC/DC**
- _ Max. load
018017: 60 VA, 018027/018037: 20 VA
- _ Protection circuit **Z-Diode**
- _ Operating indicator (2pcs.) **LED green**
- _ Protection class **IP65**
- _ Sealing material **Desmopan**
- _ Temperature range **–30 °C to +90 °C**

- _ Kontaktabstand Bauform A **18 mm**
- _ Kontaktabstand Bauform B/Ind. **11 mm**
- _ Kontaktabstand Bauform B/DIN **10 mm**
- _ Nennspannung **24 VAC/DC**
- _ Max. Schaltleistung
018017: 60 VA, 018027/018037: 20 VA
- _ Schutzbeschaltung **Z-Diode**
- _ Statusanzeige (2 Stk.) **LED grün**
- _ Schutzart **IP65**
- _ Aussenmaterial **Desmopan**
- _ Temperaturbereich **–30 °C bis +90 °C**

SENSOR-TOUCHLESS/TASTER-BERÜHRUNGSLOS CAPACITIVE/KAPAZITIV

Sensor-touchless/Taster-berührungslos
Capacitive/Kapazitiv

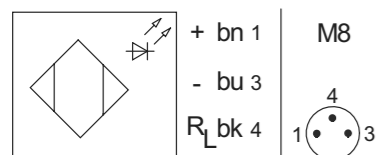

DETAILS

_ Rated voltage **18 to 32 V**

_ Switching current **0,4 A**

_ Operating indicator **LED yellow/red**

_ Housing material **PP**

_ Protection class **IP67**

_ Electrical Connection **M8/3-poles/male**

_ Measurements **50 x 27 x 6,5 mm**

_ Temperature range **-20 °C to +80 °C**

_ Protected against polarity reversal

_ Short circuit proof

_ Direktive 2002/99/EC (RoHS)

_ Betriebsspannung **18 bis 32 V**

_ Schaltstrom **0,4 A**

_ Betriebsanzeige **LED gelb/rot**

_ Gehäuse Material **PP**

_ Schutzart **IP67**

_ Elektrischer Anschluss **M8/3-polig/Stecker**

_ Abmessungen **50 x 27 x 6,5 mm**

_ Temperaturbereich **-20 °C bis +80 °C**

_ Verpolungssicher

_ Kurzschlußfest

_ Richtlinie 2002/99/EC (RoHS)

ORDER CODE/BESTELLNUMMERN

VALVE TIMER/VENTIL TIMER, LIGHT GASKET/LEUCHTDICHTUNG, SENSOR-TOUCHLESS/TASTER-BERÜHRUNGSLOS

VALVE TIMER/ FORM A · B-IND./VENTIL TIMER/BAUFORM A · B-IND.



Form	Part No.
Bauform	Artikel Nr.
A · 18 mm	990720
B · 11 mm	991260

LIGHT GASKET/ FORM A · B/LEUCHTDICHTUNG/BAUFORM A · B



Form	Part No.	Special Feature
Bauform	Artikel Nr.	Besonderheit
A · 18 mm	018017	VW-Mat. 123/3384
B · 11 mm	018027	
B · 10 mm	018037	VW-Mat. 123/3387

SENSOR-TOUCHLESS/CAPACITIVE/TASTER-BERÜHRUNGSLOS/KAPAZITIV



Part No.

Artikel Nr.

990949

PROXIMITY SENSORS/ZYLINDER NÄHERUNGSSCHALTER

REED/REEDKONTAKT

Proximity sensors/Zylinder Näherungsschalter
Reed/Reedkontakt

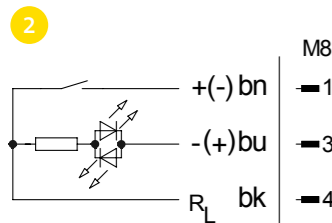
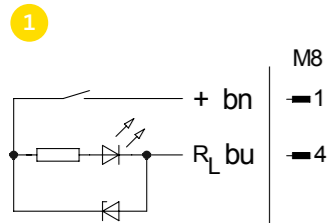
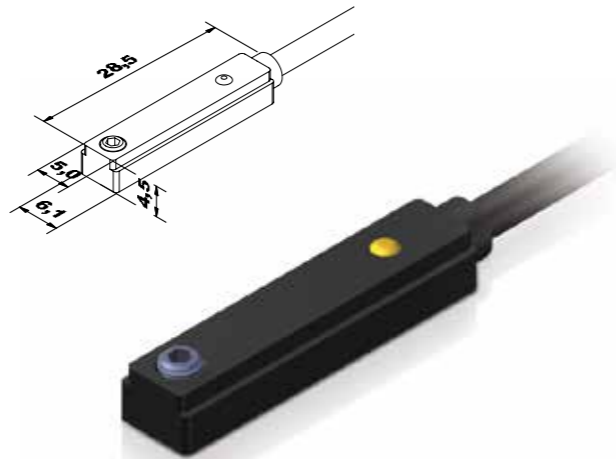

DETAILS

_ Operating voltage (2-wire) 10 to 240 VAC (M8: 60 V), 10 to 170 VDC (M8: 75 V)	_ Betriebsspannung (2-Draht) 10 bis 240 VAC (M8: 60 V), 10 to 170 VDC (M8: 75 V)
_ Operating voltage (3-wire) 10 to 30 VAC/DC	_ Betriebsspannung (3-Draht) 10 bis 30 VAC/DC
_ Switching current 300 mA	_ Schaltstrom 300 mA
_ Load max. 8 W	_ Schaltleistung max. 8 W
_ Operating indicator LED yellow	_ Betriebsanzeige LED gelb
_ Cable PUR 2 (3) x 0,14 mm ²	_ Anschlußleitung PUR 2 (3) x 0,14 mm ²
_ Protection class IP67	_ Schutzart IP67
_ Housing material PA	_ Gehäusematerial PA
_ Measurements 5,0/6,1 x 4,5 x 28,5 mm	_ Abmessungen 5,0/6,1 x 4,5 x 28,5 mm
_ Locking system screw	_ Befestigung Schraube
_ Temperature range -20 °C to +80 °C	_ Temperaturbereich -20 °C bis +80 °C

PROXIMITY SENSORS/ZYLINDER NÄHERUNGSSCHALTER

GMR

Proximity sensors/Zylinder Näherungsschalter
GMR

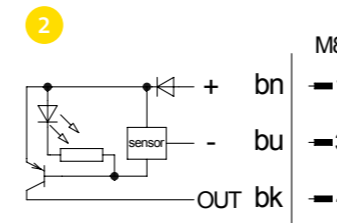
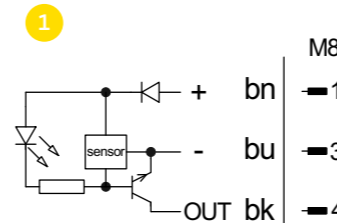
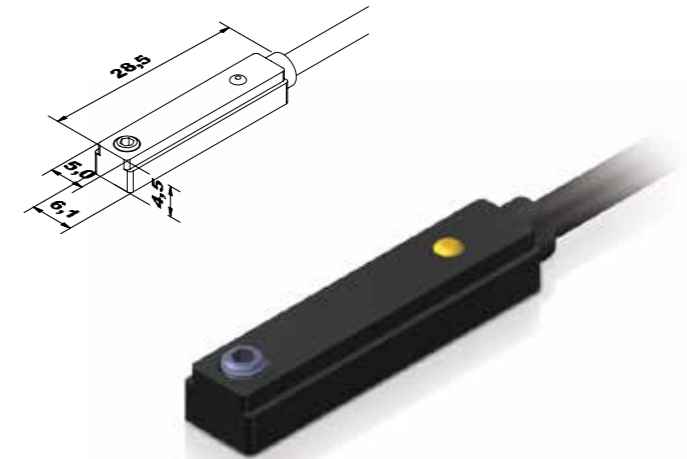

DETAILS

_ Operating voltage 5 to 30 VDC	_ Betriebsspannung 5 bis 30 VDC
_ Switching current max. 200 mA	_ Schaltstrom max. 200 mA
_ Load max. 5 W	_ Schaltleistung max. 5 W
_ Operating indicator LED yellow	_ Betriebsanzeige LED gelb
_ Cable PUR 3 x 0,14 mm ²	_ Anschlußleitung PUR 3 x 0,14 mm ²
_ Protection class IP67	_ Schutzart IP67
_ Housing material PA	_ Gehäusematerial PA
_ Measurements 5,0/6,1 x 4,5 x 28,5 mm	_ Abmessungen 5,0/6,1 x 4,5 x 28,5 mm
_ Locking system screw	_ Befestigung Schraube
_ Temperature range -20 °C to +70 °C	_ Temperaturbereich -20 °C bis +70 °C

PROXIMITY SENSORS TOP MOUNT/ ZYLINDER NÄHERUNGSSCHALTER TOP MOUNT REED/REEDKONTAKT

Proximity sensors Top Mount/
Zylinder Näherungsschalter Top Mount
Reed/Reedkontakt



1

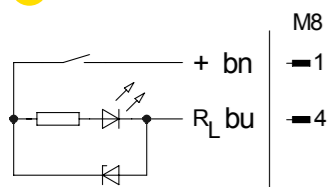

2

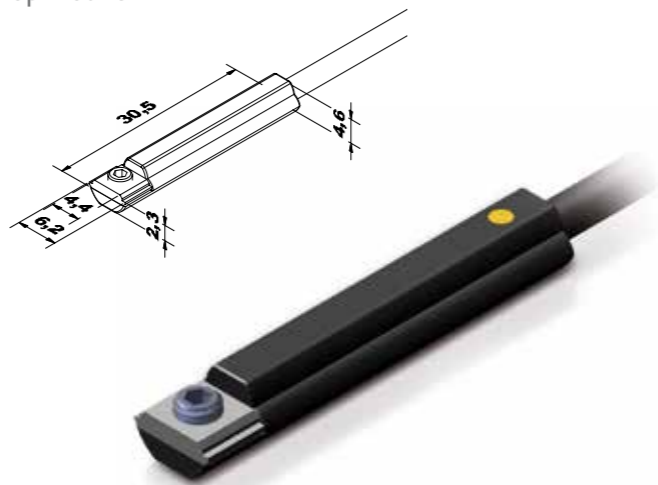
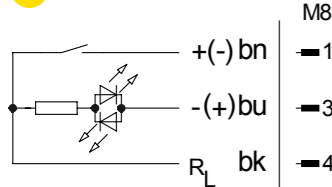

DETAILS

- _ Operating voltage (2-wire) 10 to 240 VAC (M8: 60 V), 10 to 170 VDC (M8: 75 V)
- _ Operating voltage (3-wire) 10 to 30 VAC/DC
- _ Switching current 300 mA
- _ Load max. 8 W
- _ Operating indicator LED yellow
- _ Cable PUR 2 (3) x 0,14 mm²
- _ Protection class IP67
- _ Housing material PA
- _ Measurements 4,4/6,2 x 4,6 x 30,5 mm
- _ Locking system screw
- _ Temperature range -20 °C to +80 °C

- _ Betriebsspannung (2-Draht) 10 bis 240 VAC (M8: 60 V), 10 bis 170 VDC (M8: 75 V)
- _ Betriebsspannung (3-Draht) 10 bis 30 VAC/DC
- _ Schaltstrom 300 mA
- _ Schaltleistung max. 8 W
- _ Betriebsanzeige LED gelb
- _ Anschlußleitung PUR 2 (3) x 0,14 mm²
- _ Schutzart IP67
- _ Gehäusematerial PA
- _ Abmessungen 4,4/6,2 x 4,6 x 30,5 mm
- _ Befestigung Schraube
- _ Temperaturbereich -20 °C bis +80 °C

PROXIMITY SENSORS TOP MOUNT/ ZYLINDER NÄHERUNGSSCHALTER TOP MOUNT GMR

Proximity sensors Top Mount/
Zylinder Näherungsschalter Top Mount
GMR



1

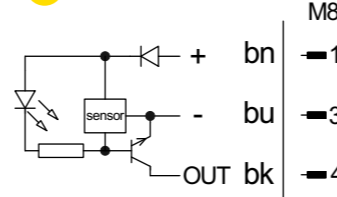

2

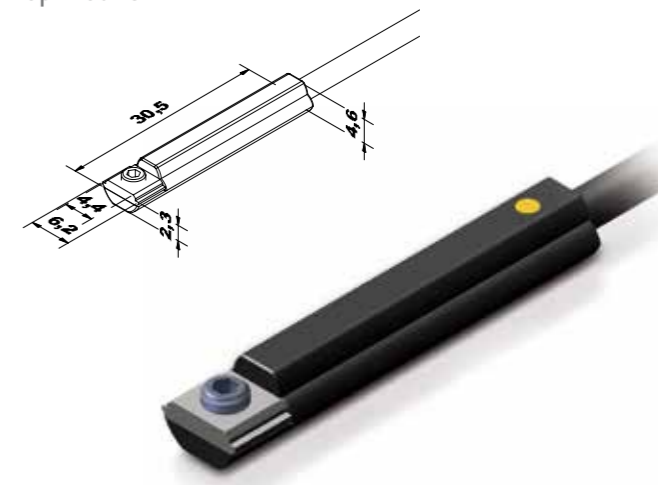
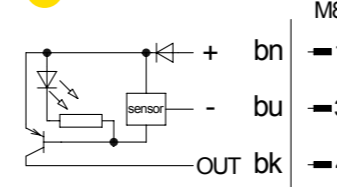

DETAILS

- _ Operating voltage 5 to 30 VDC
- _ Switching current max. 200 mA
- _ Load max. 5 W
- _ Operating indicator LED yellow
- _ Cable PUR 3 x 0,14 mm²
- _ Protection class IP67
- _ Housing material PA
- _ Measurements 4,4/6,2 x 4,6 x 30,5 mm
- _ Locking system screw
- _ Temperature range -20 °C to +70 °C

- _ Betriebsspannung 5 bis 30 VDC
- _ Schaltstrom max. 200 mA
- _ Schaltleistung max. 5 W
- _ Betriebsanzeige LED gelb
- _ Anschlußleitung PUR 3 x 0,14 mm²
- _ Schutzart IP67
- _ Gehäusematerial PA
- _ Abmessungen 4,4/6,2 x 4,6 x 30,5 mm
- _ Befestigung Schraube
- _ Temperaturbereich -20 °C bis +70 °C

ORDER CODE/BESTELLNUMMERN

PROXIMITY SENSORS/ZYLINDER NÄHERUNGSSCHALTER

REED/REEDKONTAKT/GMR

PROXIMITY SENSORS/ZYLINDER NÄHERUNGSSCHALTER/REED/REEDKONTAKT

Type · circuit/ Ausführung · Schaltbild	1 m	3 m	5m	M 8 x 1
	Part No.	Part No.	Part No.	Part No.
	Artikel Nr.	Artikel Nr.	Artikel Nr.	Artikel Nr.
2-wire/2-Draht · 1	262641	262643	262645	262680
3-wire/3-Draht · 2	263241	263243	263245	263280

PROXIMITY SENSORS/ZYLINDER NÄHERUNGSSCHALTER/GMR

Type · circuit/ Ausführung · Schaltbild	1 m	3 m	5m	M 8 x 1
	Part No.	Part No.	Part No.	Part No.
	Artikel Nr.	Artikel Nr.	Artikel Nr.	Artikel Nr.
GMR-pnp · 1	264241	264243	264245	264280
GMR-npn · 2	265241	265243	265245	265280

PROXIMITY SENSORS/ZYLINDER NÄHERUNGSSCHALTER/ TOP MOUNT/REED/REEDKONTAKT

Type · circuit/ Ausführung · Schaltbild	1 m	3 m	5m	M 8 x 1
	Part No.	Part No.	Part No.	Part No.
	Artikel Nr.	Artikel Nr.	Artikel Nr.	Artikel Nr.
2-wire/2-Draht · 1	272641	272643	272645	272680
3-wire/3-Draht · 2	273241	273243	273245	273280

PROXIMITY SENSORS/ZYLINDER NÄHERUNGSSCHALTER/ TOP MOUNT/GMR

Type · circuit/ Ausführung · Schaltbild	1 m	3 m	5m	M 8 x 1
	Part No.	Part No.	Part No.	Part No.
	Artikel Nr.	Artikel Nr.	Artikel Nr.	Artikel Nr.
GMR-pnp · 1	274241	274243	274245	274280
GMR-npn · 2	275241	275243	275245	275280

NOTES

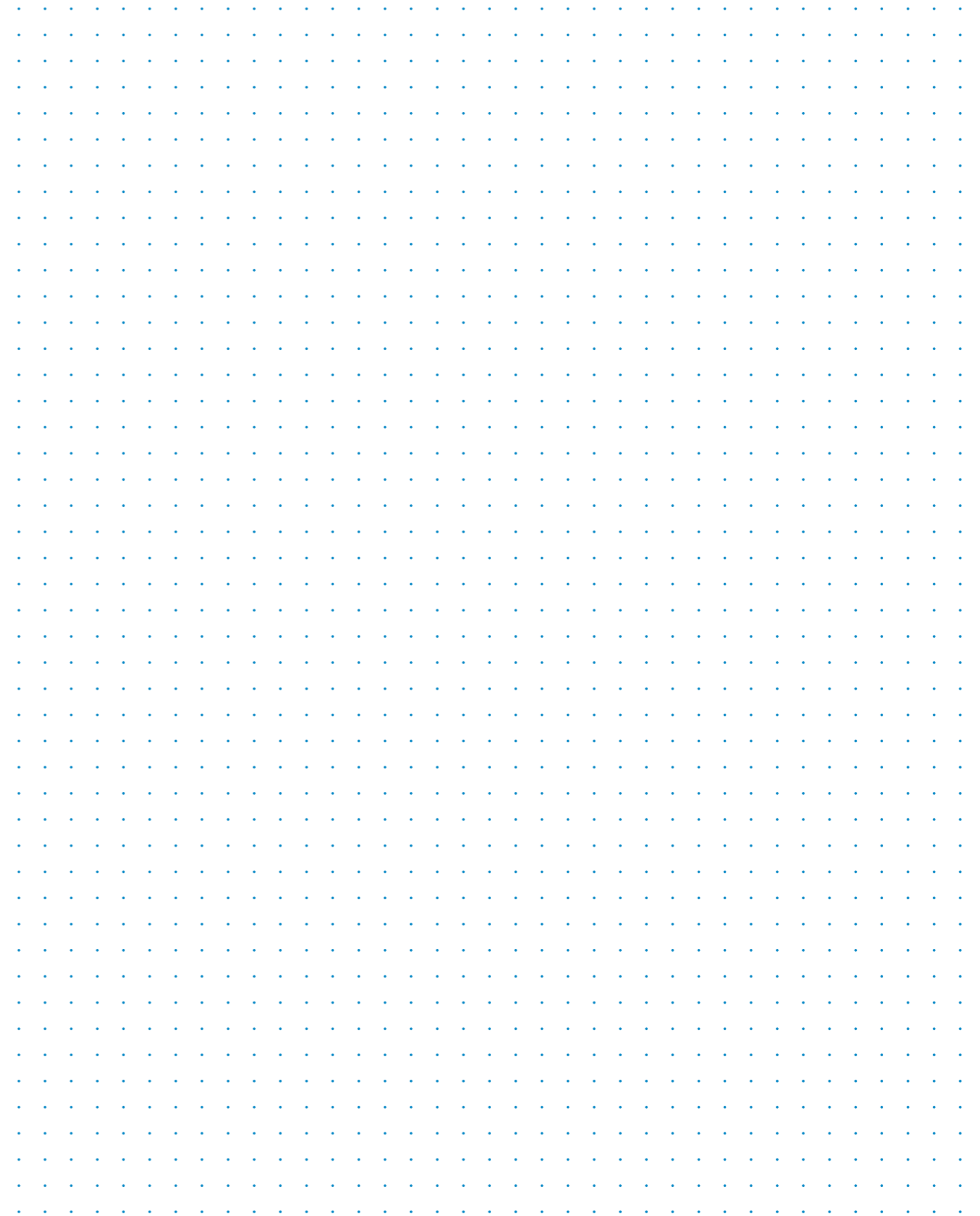
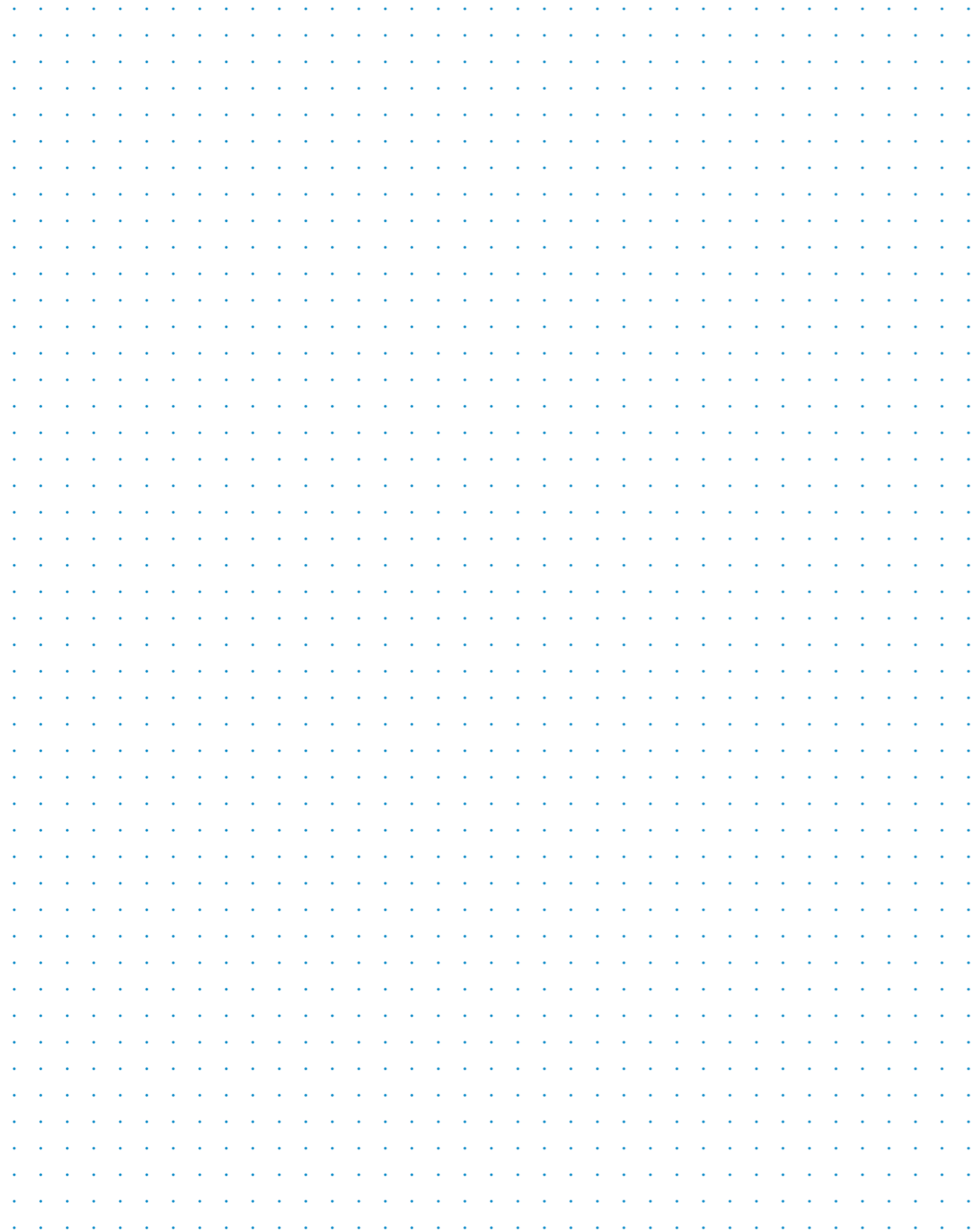

RELAY MODULE · 1 NO CONTACT/COIL 24 V TO 230 V RELAISMODUL · 1 SCHLIESSER/SPULE 24 V BIS 230 V

Relay module · 1 NO contact/Relaismodul · 1 Schließer
Coil 24 V to 230 V/ Spule 24 V bis 230 V

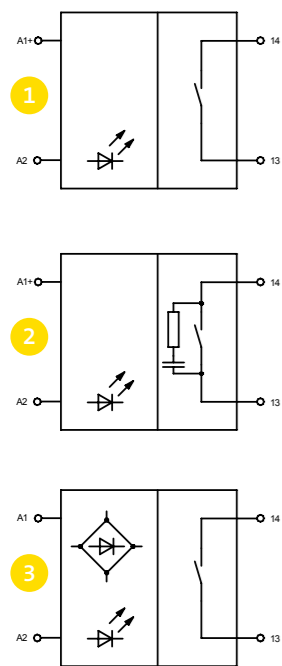

DETAILS

- _ Switching voltage **400 VAC/150 VDC**
- _ Starting/permanent current **10 A/8 A**
- _ Max. power rating **2000 VA/192 W**
- _ Contact resistance **< 30 mOhm**
- _ Contact material **AgCdO**
- _ Energize/release time **10/15 ms**
- _ Switching frequency **10 Hz**
- _ Protection circuit **Diode**
- _ Test insulation voltage **4 kV**
- _ Insulation group **VDE 0110 Gr. C**
- _ Operation indicator **LED yellow**
- _ Measurements **11,5 x 54 x 60 mm**
- _ Fastening **DIN-rail**
- _ Temperature range **-20 °C to +50 °C**

- _ Schaltspannung **400 VAC/150 VDC**
- _ Einschalt-/Dauerstrom **10 A/8 A**
- _ Schaltleistung max. **2000 VA/192 W**
- _ Kontaktwiderstand **< 30 mOhm**
- _ Kontaktmaterial **AgCdO**
- _ Ansprech-/Rückfallzeit **10/15 ms**
- _ Schaltfrequenz **10 Hz**
- _ Schutzbeschaltung **Diode**
- _ Prüf-Isolationsspannung **4 kV**
- _ Isolationsgrupp **VDE 0110 Gr. C**
- _ Betriebsanzeige **LED gelb**
- _ Abmessungen **11,5 x 54 x 60 mm**
- _ Befestigung **DIN-Schiene**
- _ Temperaturbereich **-20 °C bis +50 °C**

RELAY MODULE · 1 NC CONTACT/COIL 24 V TO 230 V RELAISMODUL · 1 ÖFFNER/SPULE 24 V BIS 230 V

Relay module · 1 NC contact/Relaismodul · 1 Öffner
Coil 24 V to 230 V/ Spule 24 V bis 230 V

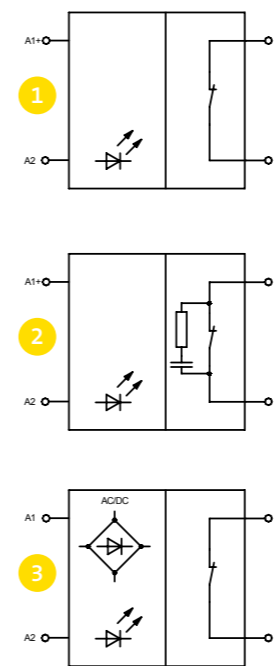

DETAILS

- _ Switching voltage **400 VAC/150 VDC**
- _ Starting/permanent current **10 A/8 A**
- _ Max. power rating **2000 VA/192 W**
- _ Contact resistance **< 30 mOhm**
- _ Contact material **AgCdO**
- _ Energize/release time **10/15 ms**
- _ Switching frequency **10 Hz**
- _ Protection circuit **Diode**
- _ Test insulation voltage **4 kV**
- _ Insulation group **VDE 0110 Gr. C**
- _ Operation indicator **LED yellow**
- _ Measurements **11,5 x 54 x 60 mm**
- _ Fastening **DIN-rail**
- _ Temperature range **-20 °C to +50 °C**

- _ Schaltspannung **400 VAC/150 VDC**
- _ Einschalt-/Dauerstrom **10 A/8 A**
- _ Schaltleistung max. **2000 VA/192 W**
- _ Kontaktwiderstand **< 30 mOhm**
- _ Kontaktmaterial **AgCdO**
- _ Ansprech-/Rückfallzeit **10/15 ms**
- _ Schaltfrequenz **10 Hz**
- _ Schutzbeschaltung **Diode**
- _ Prüf-Isolationsspannung **4 kV**
- _ Isolationsgrupp **VDE 0110 Gr. C**
- _ Betriebsanzeige **LED gelb**
- _ Abmessungen **11,5 x 54 x 60 mm**
- _ Befestigung **DIN-Schiene**
- _ Temperaturbereich **-20 °C bis +50 °C**

RELAY MODULE · 2 NO · 2 NC · 1 CO CONTACT
RELAISMODUL · 2 SCHLIEßER · 2 ÖFFNER · 1 WECHSLER
COIL 24 V TO 230 V/SPULE 24 V BIS 230 V

Relay module · 2 NO · 2 NC · 1 CO contact
 Relaismodul · 2 Schließer · 2 Öffner · 1 Wechsler
 Coil 24 V to 230 V/ Spule 24 V bis 230 V

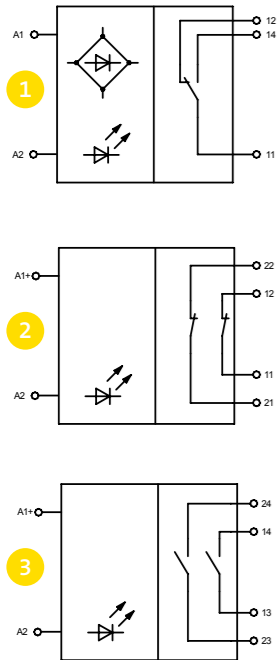

DETAILS

_ Switching voltage 400 VAC/150 VDC	_ Schaltspannung 400 VAC/150 VDC
_ Starting/permanent current 10 A/8 A	_ Einschalt-/Dauerstrom 10 A/8 A
_ Max. power rating 2000 VA/192 W	_ Schaltleistung max. 2000 VA/192 W
_ Contact resistance < 30 mOhm	_ Kontaktwiderstand < 30 mOhm
_ Contact material AgCdO	_ Kontaktmaterial AgCdO
_ Energize/release time 10/15 ms	_ Ansprech-/Rückfallzeit 10/15 ms
_ Switching frequency 10 Hz	_ Schaltfrequenz 10 Hz
_ Protection circuit Diode	_ Schutzbeschaltung Diode
_ Test insulation voltage 4 kV	_ Prüf-Isolationsspannung 4 kV
_ Insulation group VDE 0110 Gr. C	_ Isolationsgrupp VDE 0110 Gr. C
_ Operation indicator LED yellow	_ Betriebsanzeige LED gelb
_ Measurements 11,5 x 72 x 60 mm	_ Abmessungen 11,5 x 72 x 60 mm
_ Fastening DIN-rail	_ Befestigung DIN-Schiene
_ Temperature range -20 °C to +50 °C	_ Temperaturbereich -20 °C bis +50 °C

RELAY MODULE · 2 CO CONTACT/COIL 24 V TO 230 V
RELAISMODUL · 2 WECHSLER/SPULE 24 V BIS 230 V

Relay module · 2 CO contact/Relaismodul · 2 Wechsler
 Coil 24 V to 230 V/ Spule 24 V bis 230 V

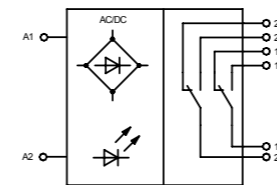

DETAILS

_ Switching voltage 230 VAC/250 VDC	_ Schaltspannung 230 VAC/250 VDC
_ Starting/permanent current 5 A/2 A	_ Einschalt-/Dauerstrom 5 A/2 A
_ Max. power rating 250 VA/150 W	_ Schaltleistung max. 250 VA/150 W
_ Contact resistance < 30 mOhm	_ Kontaktwiderstand < 30 mOhm
_ Contact material Ag/Au	_ Kontaktmaterial Ag/Au
_ Energize/release time 3/4 ms	_ Ansprech-/Rückfallzeit 3/4 ms
_ Switching frequency 10 Hz	_ Schaltfrequenz 10 Hz
_ Protection circuit Diode	_ Schutzbeschaltung Diode
_ Test insulation voltage 1,5 kV	_ Prüf-Isolationsspannung 1,5 kV
_ Insulation group VDE 0110 Gr. B	_ Isolationsgrupp VDE 0110 Gr. B
_ Operation indicator LED yellow	_ Betriebsanzeige LED gelb
_ Measurements 11,5 x 72 x 60 mm	_ Abmessungen 11,5 x 72 x 60 mm
_ Fastening DIN-rail	_ Befestigung DIN-Schiene
_ Temperature range -20 °C to +50 °C	_ Temperaturbereich -20 °C bis +50 °C

RELAY MODULE · 1 NO CONTACT/COIL 24 V TO 230 V

RELAISMODUL · 1 SCHLIESSER/SPULE 24 V BIS 230 V

Relay module · 1 NO contact/Relaismodul · 1 Schließer
Coil 24 V to 230 V/ Spule 24 V bis 230 V
Slim design/Schmale Bauform

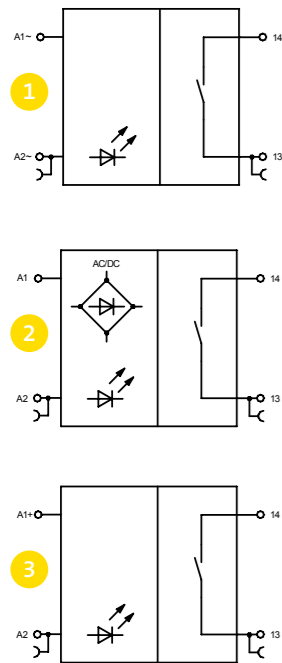

DETAILS

_ Switching voltage **250 VAC/300 VDC**

_ Starting/permanent current **6 A**

_ Max. power rating **1500 VA/240 W**

_ Contact resistance < **30 mOhm**

_ Contact material **AgSnO2**

_ Energize/release time **10/15 ms**

_ Switching frequency **10 Hz**

_ Protection circuit **Diode**

_ Test insulation voltage **4 kV**

_ Insulation group **VDE 0110 Gr. C**

_ Operation indicator **LED yellow**

_ Measurements **6,2 x 85 x 81 mm**

_ Fastening **DIN-rail**

_ Temperature range **-20 °C to +50 °C**

_ Accessories part no. 099063 **Bridging connector 24-pins**

_ Schaltspannung **400 VAC/150 VDC**

_ Einschalt-/Dauerstrom **6 A**

_ Schaltleistung max. **1500 VA/240 W**

_ Kontaktwiderstand < **30 mOhm**

_ Kontaktmaterial **AgSnO2**

_ Ansprech-/Rückfallzeit **10/15 ms**

_ Schaltfrequenz **10 Hz**

_ Schutzbeschaltung **Diode**

_ Prüf-Isolationsspannung **4 kV**

_ Isolationsgrupp **VDE 0110 Gr. C**

_ Betriebsanzeige **LED gelb**

_ Abmessungen **6,2 x 85 x 81 mm**

_ Befestigung **DIN-Schiene**

_ Temperaturbereich **-20 °C bis +50 °C**

_ Zubehör Art. Nr. 099063 **Potentialbrücke 24-fach**

RELAY MODULE · 1 CO CONTACT/COIL 24 V TO 230 V

RELAISMODUL · 1 WECHSLER/SPULE 24 V BIS 230 V

Relay module · 1 CO contact/Relaismodul · 1 Wechsler
Coil 24 V to 230 V/ Spule 24 V bis 230 V
Slim design/Schmale Bauform

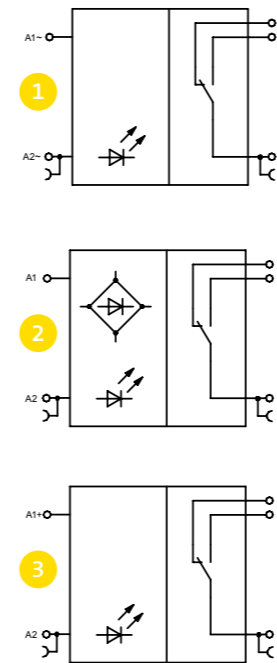

DETAILS

_ Switching voltage **250 VAC/300 VDC**

_ Starting/permanent current **6 A**

_ Max. power rating **1500 VA/240 W**

_ Contact resistance < **30 mOhm**

_ Contact material **AgSnO2**

_ Energize/release time **10/15 ms**

_ Switching frequency **10 Hz**

_ Protection circuit **Diode**

_ Test insulation voltage **4 kV**

_ Insulation group **VDE 0110 Gr. C**

_ Operation indicator **LED yellow**

_ Measurements **6,2 x 85 x 81 mm**

_ Fastening **DIN-rail**

_ Temperature range **-20 °C to +50 °C**

_ Accessories part no. 099063 **Bridging connector 24-pins**

_ Schaltspannung **400 VAC/150 VDC**

_ Einschalt-/Dauerstrom **6 A**

_ Schaltleistung max. **1500 VA/240 W**

_ Kontaktwiderstand < **30 mOhm**

_ Kontaktmaterial **AgSnO2**

_ Ansprech-/Rückfallzeit **10/15 ms**

_ Schaltfrequenz **10 Hz**

_ Schutzbeschaltung **Diode**

_ Prüf-Isolationsspannung **4 kV**

_ Isolationsgrupp **VDE 0110 Gr. C**

_ Betriebsanzeige **LED gelb**

_ Abmessungen **6,2 x 85 x 81 mm**

_ Befestigung **DIN-Schiene**

_ Temperaturbereich **-20 °C bis +50 °C**

_ Zubehör Art. Nr. 099063 **Potentialbrücke 24-fach**

OPTO-COUPLER/1 A TO 4 A OPTOKOPPLER/1 A BIS 4 A

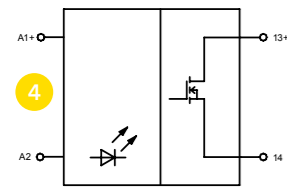
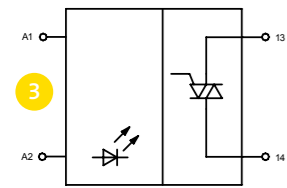
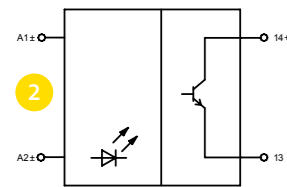
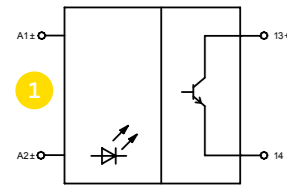

Opto-coupler/Optokoppler
1 A to 4 A/1 A bis 4 A



DETAILS

_ Control current ≤ 12 mA

_ Switching current (min.) 10 mA

_ Energize/release time $\leq 4/\leq 8$ ms

_ Test insulation voltage 2,5 kV

_ Insulation group VDE 0110 Gr. C

_ Operation indicator LED yellow

_ Measurements 11,5 x 54 x 60 mm

_ Fastening DIN-rail

_ Temperature range -20 °C to $+50$ °C

_ Overload protection Part no. 030400

_ Stromaufnahme ≤ 12 mA

_ Schaltstrom (min.) 10 mA

_ Schaltzeit EIN/AUS $\leq 4/\leq 8$ ms

_ Prüf-Isolationsspannung 2,5 kV

_ Isolationsgrupp VDE 0110 Gr. C

_ Betriebsanzeige LED gelb

_ Abmessungen 11,5 x 54 x 60 mm

_ Befestigung DIN-Schiene

_ Temperaturbereich -20 °C bis $+50$ °C

_ Überlastschutz Art. Nr. 030400

OPTO-COUPLER/0,5 A TO 2 A OPTOKOPPLER/0,5 A BIS 2 A

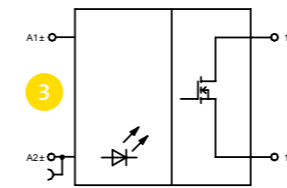
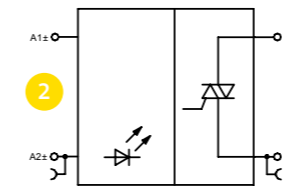
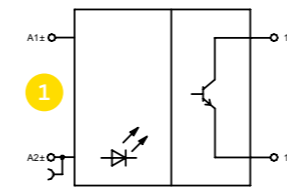

Opto-coupler/Optokoppler
0,5 A to 2 A/0,5 A bis 2 A



DETAILS

_ Control current ≤ 12 mA

_ Switching current (min.) 10 mA

_ Energize/release time $\leq 4/\leq 8$ ms

_ Test insulation voltage 2,5 kV

_ Insulation group VDE 0110 Gr. C

_ Operation indicator LED yellow

_ Measurements 6,2 x 85 x 81 mm

_ Fastening DIN-rail

_ Temperature range -20 °C to $+50$ °C

_ Accessories part no. 099063 Bridging connector 24-pins

_ Overload protection Part no. 032215/032240

_ Stromaufnahme ≤ 12 mA

_ Schaltstrom (min.) 10 mA

_ Schaltzeit EIN/AUS $\leq 4/\leq 8$ ms

_ Prüf-Isolationsspannung 2,5 kV

_ Isolationsgrupp VDE 0110 Gr. C

_ Betriebsanzeige LED gelb

_ Abmessungen 6,2 x 85 x 81 mm

_ Befestigung DIN-Schiene

_ Temperaturbereich -20 °C bis $+50$ °C

_ Zubehör Art. Nr. 099063 Potentialbrücke 24-fach

_ Überlastschutz Art. Nr. 032215/032240

ORDER CODE/BESTELLNUMMERN

RELAY MODULE/ RELAISMODUL

OPTO-COUPLER/ OPTOKOPPLER

RELAY MODULE · 1 NO CONTACT/RELAISMODUL · 1 SCHLIESSER



Voltage · circuit/ Spannung · Schaltbild

Part No./Artikel Nr.

24 VDC · 1	030064
24 VDC + RC · 2	030065
24 VAC/DC · 3	030050
60 VAC/DC · 3	030081
115 VAC/DC · 3	030084
230 VAC/DC · 3	030056

RELAY MODULE · 1 NC CONTACT/RELAISMODUL · 1 ÖFFNER



Voltage · circuit/ Spannung · Schaltbild

Part No./Artikel Nr.

24 VDC · 1	030068
24 VDC + RC · 2	030069
24 VAC/DC · 3	030054
60 VAC/DC · 3	030083
115 VAC/DC · 3	030085
230 VAC/DC · 3	030086

RELAY MODULE · 2 NO · 2 NC · 1 CO CONTACT/ RELAISMODUL · 2 SCHLIESSER · 2 ÖFFNER · 1 WECHSLER



Voltage · circuit/ Spannung · Schaltbild

Part No./Artikel Nr.

24 VDC · 1	030072
24 VDC · 2	030074
24 VAC/DC · 3	030058

RELAY MODULE · 2 CO CONTACT/RELAISMODUL · 2 WECHSLER



Voltage/ Spannung

Part No./Artikel Nr.

24 VAC/DC	030070
230 VAC/DC	030079

RELAY MODULE · 1 NO CONTACT/RELAISMODUL · 1 SCHLIESSER · SLIM DESIGN/SCHMALE BAUFORM



Voltage · circuit/ Spannung · Schaltbild

Part No./Artikel Nr.

24 VDC · 1	032110
115 VAC/DC · 2	032112
230 VAC · 3	032113

RELAY MODULE · 1 CO CONTACT/RELAISMODUL · 1 WECHSLER



Voltage · circuit/ Spannung · Schaltbild

Part No./Artikel Nr.

24 VDC · 1	032120
24 VAC/DC · 2	032130
115 VAC/DC · 2	032150
230 VAC · 3	032160

OPTO-COUPLER – 1 A TO 4 A/OPTOKOPPLER – 1 A BIS 4 A



Input · output · current · circuit/
Eingang · Ausgang · Strom · Schaltbild

Part No./Artikel Nr.

24 VDC · 1–48 VDC · 1,2 A · 1	030100
24 VDC · 1–48 VDC · 1,2 A · 2	030101
5 VDC · 5–48 VDC · 1,2 A · 1	030110
24 VDC · 10–260 VAC · 1,5 A · 3	030120
230 VDC · 1–400 VDC · 0,8 A · 1	030121
24 VDC · 1–48 VDC · 4 A · 4	030400

OPTO-COUPLER – 0,5 A TO 2 A/OPTOKOPPLER – 0,5 A BIS 2 A



Input · output · current · circuit/
Eingang · Ausgang · Strom · Schaltbild

Part No./Artikel Nr.

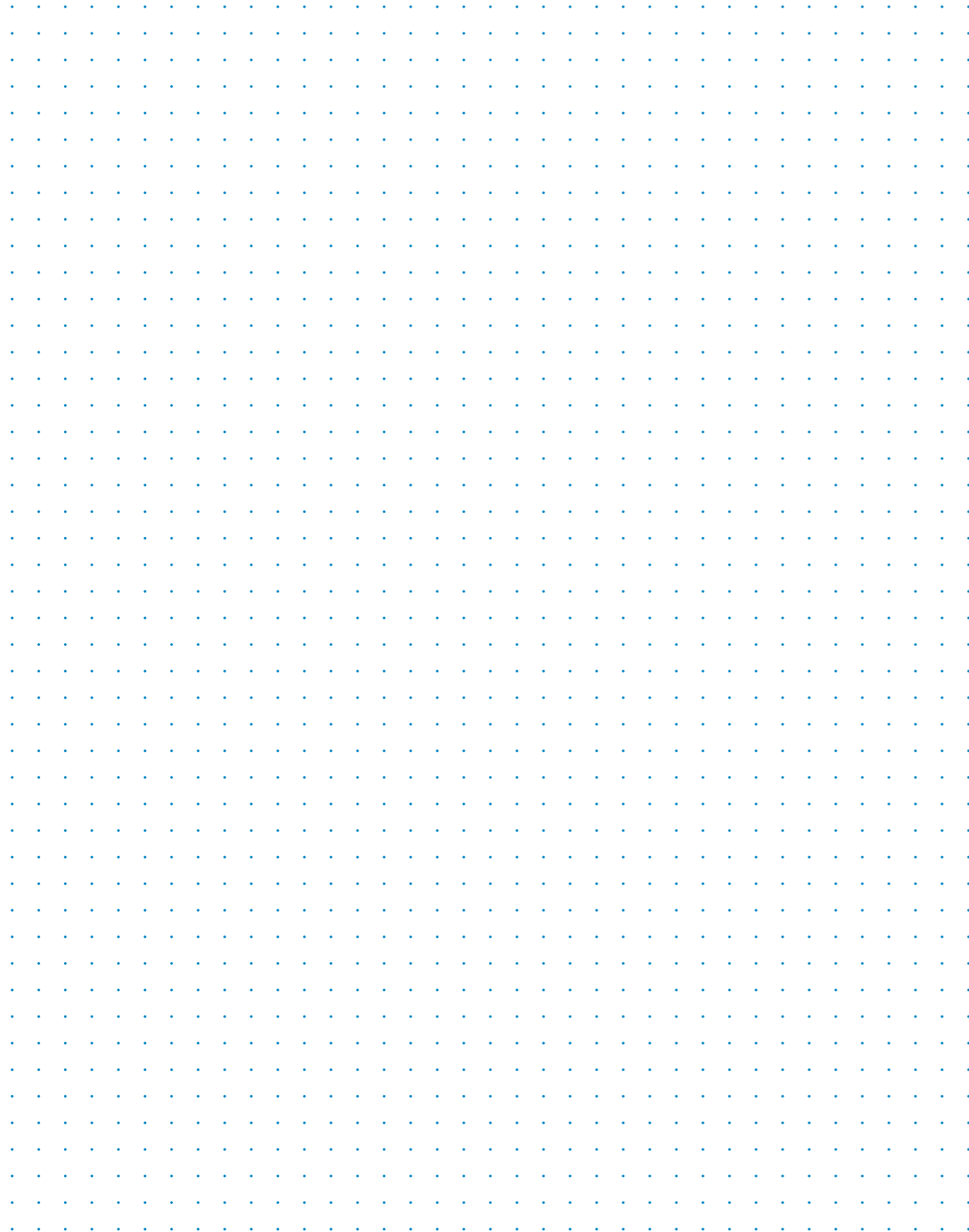

5 VDC · 5–48 VDC · 0,5 A · 1	032205
24 VDC · 12–250 VAC · 0,5 A · 2	032210
5 VDC · 5–48 VDC · 2,0 A · 3	032215
24 VDC · 1–48 VDC · 0,5 A · 1	032225
24 VDC · 1–48 VDC · 2,0 A · 3	032240



EXTRACT OF OUR
PRODUCT PORTFOLIO

EIN AUSZUG AUS UNSEREM
PRODUKTPORTFOLIO



				
Connector M12 Steckverbinder M12	Connector M12 Steckverbinder M12	M12 Actuator-/ Sensor-Box M12 Aktor-/ Sensor-Box	M8 Actuator-/ Sensor-Box M8 Aktor-/ Sensor-Box	Connector M12 Field attachable Steckverbinder M12 Konfektionierbar



			
Connector A DIN-EN PWM Steckverbinder A DIN-EN PWM	Connector B DIN-EN PWM Steckverbinder B DIN-EN PWM	PWM for magnetic coils PWM für Magnetspulen	PWM Energy Saving Module PWM Energiesparmodul



				
Delphi Connector/ Steckverbinder	Deutsch Connector/ Steckverbinder	JPT Connector/ Steckverbinder	ST3 Connector/ Steckverbinder	Superseal Connector/ Steckverbinder



Peters Indu-Produkt GmbH
Mercatorstrasse 41
46485 Wesel
Germany

T +49 (0)281.9546 0
F +49 (0)281.9546 30



info@peters-indu.de
www.peters-indu.de