



We lead the way by a new business model



WELE MECHATRONIC CO., LTD
(<http://www.welegroup.com>)

HEADQUARTERS:
No.458, Shinsing Rd., Hukou Town, Hsin-Chu County 303, Taiwan
TEL : +886-3-696-0360 (rep.) FAX : +886-3-696-0370

TAICHUNG BRANCH:
No.600, Sec. 4, Sanfeng Rd., Houli Dist., Taichung City 421, Taiwan
TEL : +886-4-2558-0762 FAX : +886-4-2558-2334

WELE MECHATRONIC (SU-ZHOU) CO., LTD.

No. 16, Fuhua Rd., Changshu Economic Development Zone,
Changshu City, Jiangsu Province, China 215513
TEL : +86-512-5229-7868 FAX : +86-512-5229-7866
SALES: 150-5141-3969,150-5141-3981



1600701 Macids TEL:04-2753326

AQSERIES

Vertical Machining Center
Linear Guideways Type

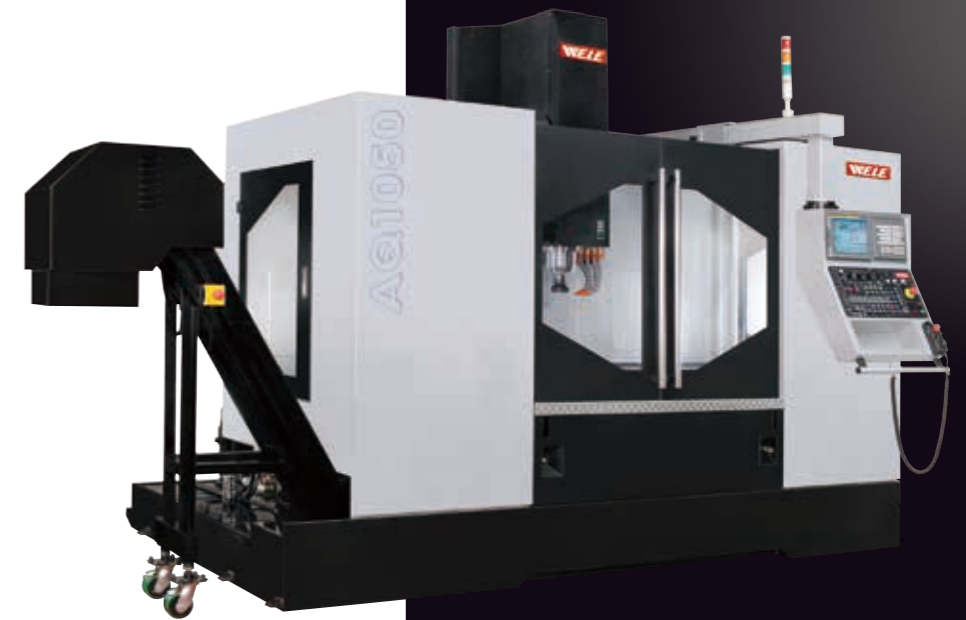

WELE MECHATRONIC CO., LTD

AQ850	AQ1050	AQ1265	AQ1465	AQ1665	AA 65 Series	AA 80 Series	AA 90 Series	AQ Series	VQ Series	UG Series	VTC Series	
					RB Series	SB Series	LB Series	MB Series	HB Series	UB Series	MG Series	MVB Series

AQ series

The machine AQ series is developing for the demand of high performance cutting, fitted with generously sized guideways and equipped with a mechanical, two steps direct spindle head as standard which is directly coupled to the precision spindle.

Feature:

- Used the ultra-heavy load, high accuracy and low friction coefficient with 0.003~0.005 roller linear guide ways, provides the high keen dynamic performance, energy consumption at least 40% can be saving.
- Every major contact surface, are all scrapped by excellent skill. Ensure the geometric accuracy in top level and satisfy customer's quality requirement.
- All major parts such as machine bed and column, are made by best quality MEEHANITE casting to ensure stability of machine.



The full equipment

The basic configuration includes very vital component. Required for demanding machining.



High performance chip discharge using Y direction screw type conveyors and X direction caterpillar type conveyor.

Detail:

- Electronic handwheel with axis selector.
- Precision spindle with directly coupled drive motor.
- Integrated spindle temperature control system.
- Automatic tool change with swing arm; 24/32/40 pockets with directional logic.
- Digitally controller AC servo motors with encoder in the X, Y and Z axis.
- Central lubrication system for all guideways and ball screws.
- Coolant unit for exterior cooling.
- Chip flush system and two sets Y direction screw type conveyors in the working envelope.
- Interior form A coolant through spindle supply, pump capacity of 20 bar as option.
- Caterpillar type conveyor to discharge chip from the machine.
- Air blast during tool change.
- Air nozzle for dry machining.
- Spray gun and air gun for cleaning operations in the working area.
- Roof enclosure guarding system.
- Preparation of electrical equipment for 4th axis connectivity
- Work lights
- Signal lamp indicating machine status.
- Foundation kit and tool box
- Transformer

Strokes	Unit	AQ850	AQ1050	AQ1265	AQ1465	AQ1665
X travel (left & right)	mm (in)	800(31.5)	1,020(40.2)	1,200(47.2)	1,400(55.1)	1,600(63.0)
Y travel (in & out)	mm (in)	510(20.1)	510(20.1)	650(25.6)	650(25.6)	650(25.6)
Z travel (up & down)	mm (in)	510(20.1)	510(20.1)	610(24.0)	610(24.0)	610(24.0)

Table dimensions	Unit	AQ850	AQ1050	AQ1265	AQ1465	AQ1665
Table size (X direction)	mm (in)	1,000(39.4)	1,200(47.2)	1,400(55.1)	1,600(63.0)	1,750(68.9)
Table size (Y direction)	mm (in)	510(20.1)	510(20.1)	650(25.6)	650(25.6)	650(25.6)
Table load capacity	kg (lb)	500(1,102.3)	600(1,322.8)	1,000(2,204.6)	1,000(2,204.6)	1,000(2,204.6)

AQ850	AQ1050	AQ1265	AQ1465	AQ1665	AA 65 Series	AA 80 Series	AA 90 Series	AQ Series	VQ Series	UG Series	VTC Series	
					RB Series	SB Series	LB Series	MB Series	HB Series	UB Series	MG Series	MVB Series

First Class of Structure Design Concept and Strictly Qualified assembly

• Tool magazine

WELE is offering the arm type tool magazine as 24 tools (STD) ; 32/40 tools (OPT)

• Significant Structure Design

Multi-tools magazine positive load on the column, decreased vibration and increased the machine stability while tool in exchange.

• Main Construction

Main constructions are made of the best quality Meehanite casting. The components are annealed and artificially aged to ensure the highest possible precision.

• Linear Guide Way

Used ultra-heavy load roller linear guideways. To ensure workpiece can obtain excellent tolerance and geometric accuracy.

• Simulation & Analysis

Refer to the Theory of Material Mechanics; The main structure is supporting by the best proportion.

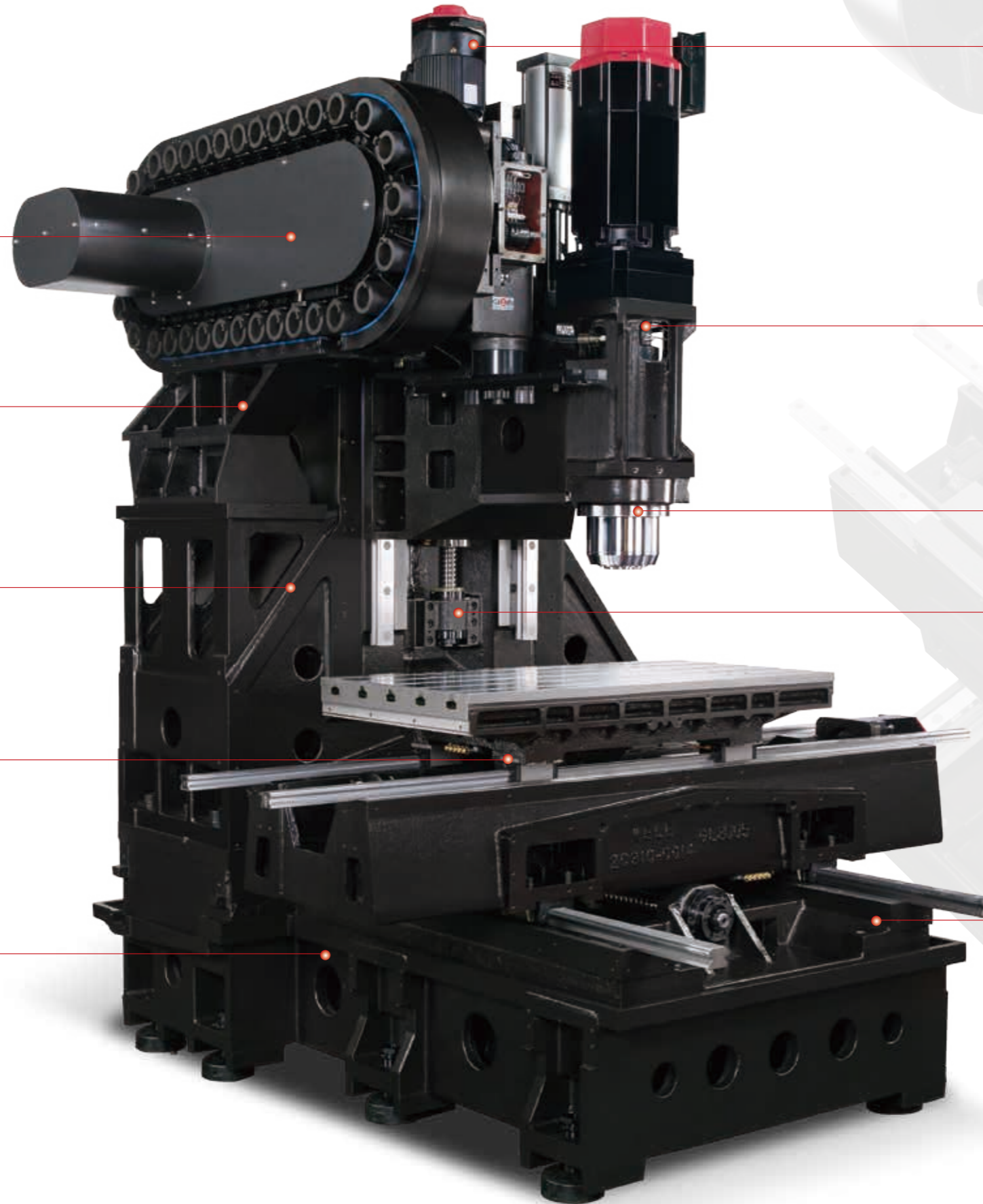

• Servo motor

Z axis brake system uses great level servo motor with α 22-B series replace counterweight to providing huge power output. Rapid dynamic response offers the precision and smooth of machining mold surface. Three axes use high end α i servo motor.
G00 (X/Y/Z) : 48/48/36 m/min (AQ50 series).

• Spindle Design

Direct driven 10,000 rpm [STD]
Direct driven 12,000 rpm [OPT]
Direct driven 15,000 rpm [OPT]

• Cutting Feedrate

G01 : 10 m/min

• Ball screw

Pretension ball screws in all 3 axes; Enhance the rigidity and backlash free on ball screw. Supplying excellent in stability and accuracy.

• Y axis travel

Super 650mm Y axis travel is the Max. range of the same class product. (AQ 65 series)



Spindle Configuration

- To ensure the machines can be using in combining rough machining and finish jobs, the AQ series has been fitted with two stages direct-driven spindle.
- More than 20 years experience in design, manufacturing, every spindle are assembled in constant temperature room, and dynamic balance check.

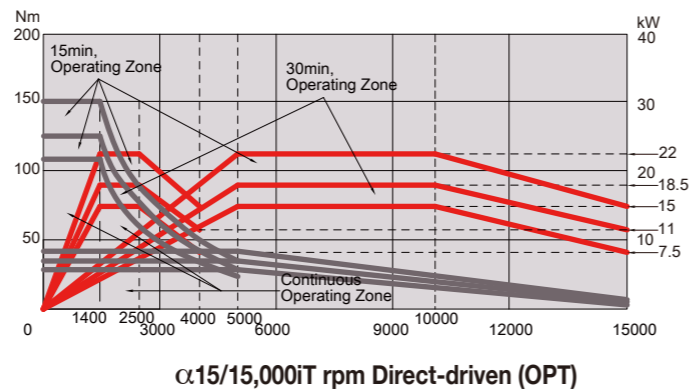
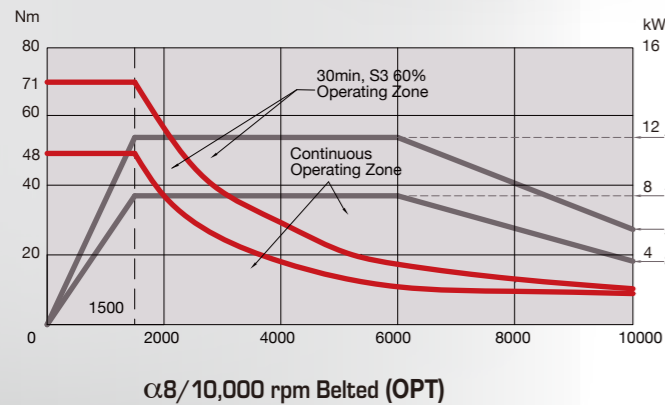
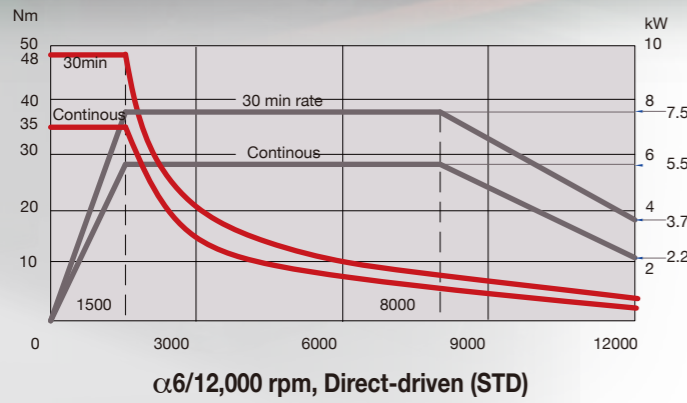
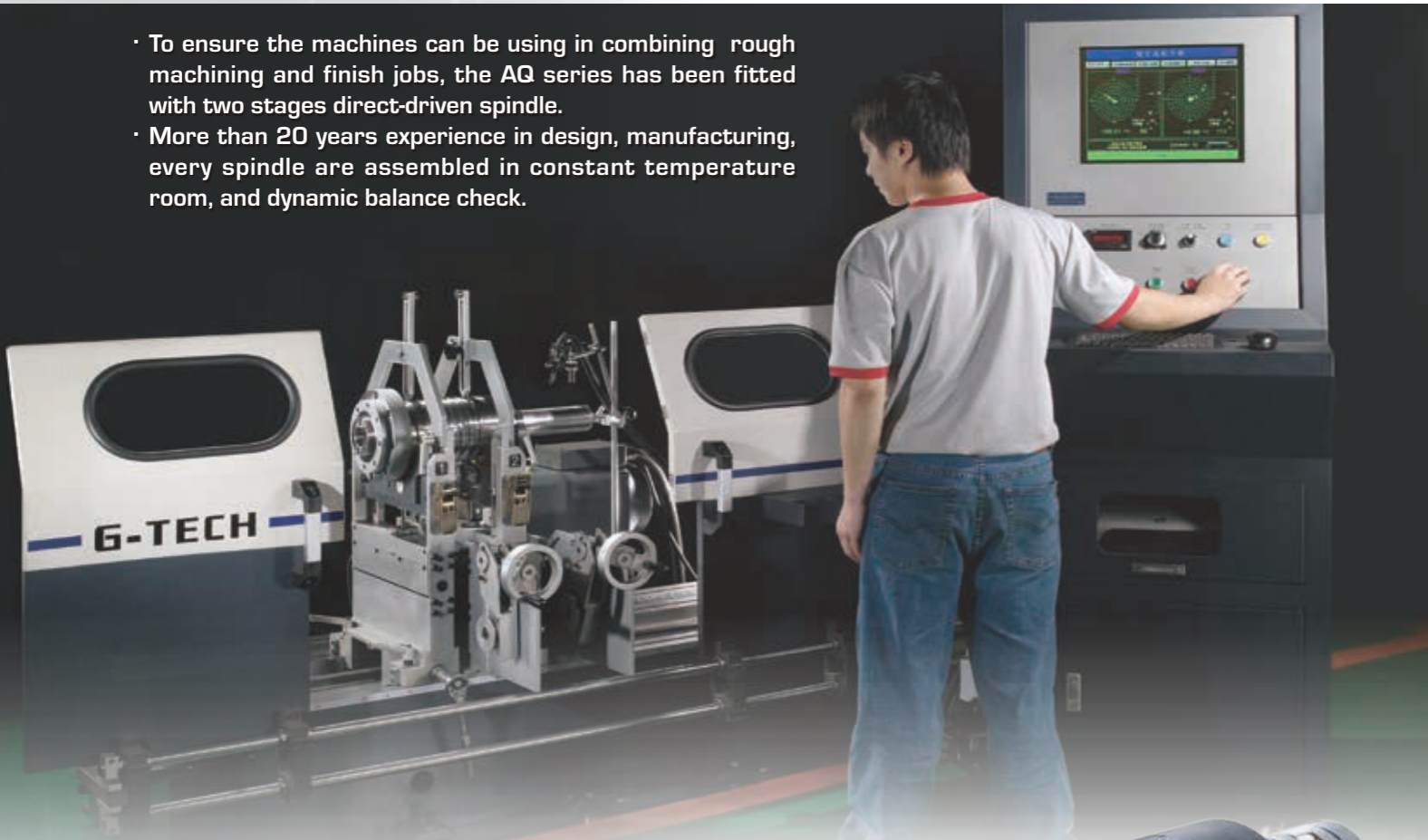

High Efficiency Cutting Performance

AQ850 Direct Driven Spindle CAT40-12000 rpm AC 15/18.5 kW (OPT) Material: S45C

Face milling	Ø80 x 8t
Spindle speed (S)	1300 rpm
Cutting velocity (Vc)	327 m/min
Cutting width (ae)	60 mm
Cutting depth (ap)	3 mm
Cutting feedrate (Vf)	2600 mm/min
Cutting feedrate per tip (fz)	0.25 mm/tooth
Cutting capacity (MRR)	468 cc/min



	Side milling	Slot milling
End milling φ32x2t		
Spindle speed (S)	1400 rpm	1400 rpm
Cutting velocity (Vc)	140 m/min	140 m/min
Cutting width (ae)	16 mm	32 mm
Cutting depth (ap)	32 mm	16 mm
Cutting feedrate (Vf)	280 mm/min	280 mm/min
Cutting feedrate per tip (fz)	0.1 mm/tooth	0.1 mm/tooth
Cutting capacity (MRR)	143 cc/min	143 cc/min



Drilling ø33	Use 20 bar CTS (Opt)
Spindle speed (S)	2000 rpm
Cutting velocity (Vc)	207 m/min
Cutting feedrate (Vf)	250 mm/min
Cutting feedrate per tip (fz)	0.125 mm/rev
Cutting capacity (MRR)	214 cc/min



	M30xP3.5	M4xP0.7
Rigid tapping		
Spindle speed (S)	180 rpm	2000 rpm
Cutting feedrate (Vf)	630 mm/min	1400 mm/min



AQ850	AQ1050	AQ1265	AQ1465	AQ1665	AA 65 Series	AA 80 Series	AA 90 Series	AQ Series	VQ Series	UG Series	VTC Series	
					RB Series	SB Series	LB Series	MB Series	HB Series	UB Series	MG Series	MVB Series

Excellent Quality Control and Assurance

Foundation of accuracy, the flatness less than 3 micro-meter in 1200mm square as standard.



- Accuracy comes from our core technology of scraping skill.
- Every major contact surfaces, are all scrapped to assure the geometric accuracy in top level and satisfy customer's quality requirement.



- Ball bar circular interpolation measurement
Optimized circular interpolation on XY, YZ, XZ planes by tuning each servo drives.

- Follow German VDI 3441 standard
To ensure the positioning and repeatability accuracy. Supplying the precision and fine geometric in workpiece.

- NASA test piece approval
Check the machine geometric and positioning accuracy by dynamic cutting procedure of NASA.

- Spindle vibration, noise checking
- Modal testing and analysis
- Every key components quality assurance was by German WENZEL 3D CMM machine.

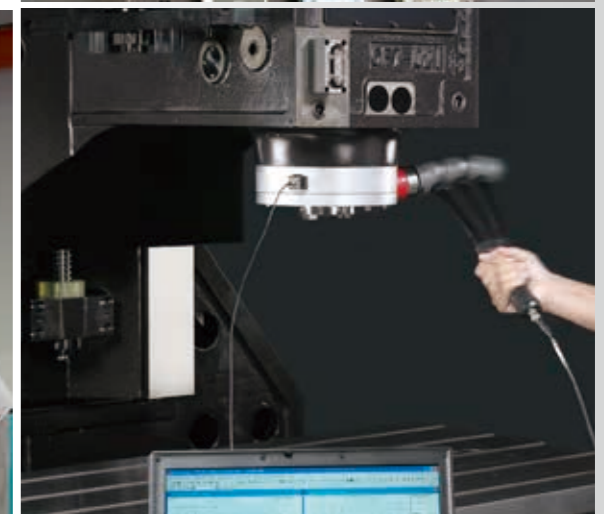
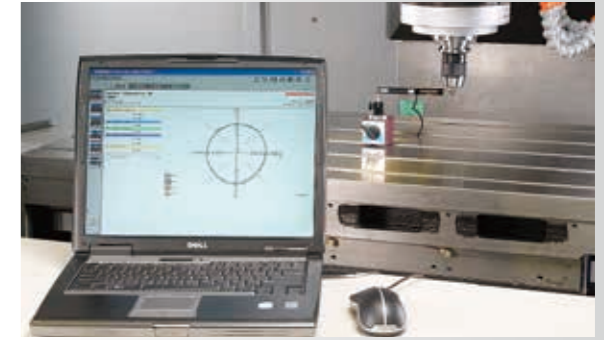

AQ850	AQ1050	AQ1265	AQ1465	AQ1665	AA 65 Series	AA 80 Series	AA 90 Series	AQ Series	VQ Series	UG Series	VTC Series	
					RB Series	SB Series	LB Series	MB Series	HB Series	UB Series	MG Series	MVB Series

User-friendly down to the last detail

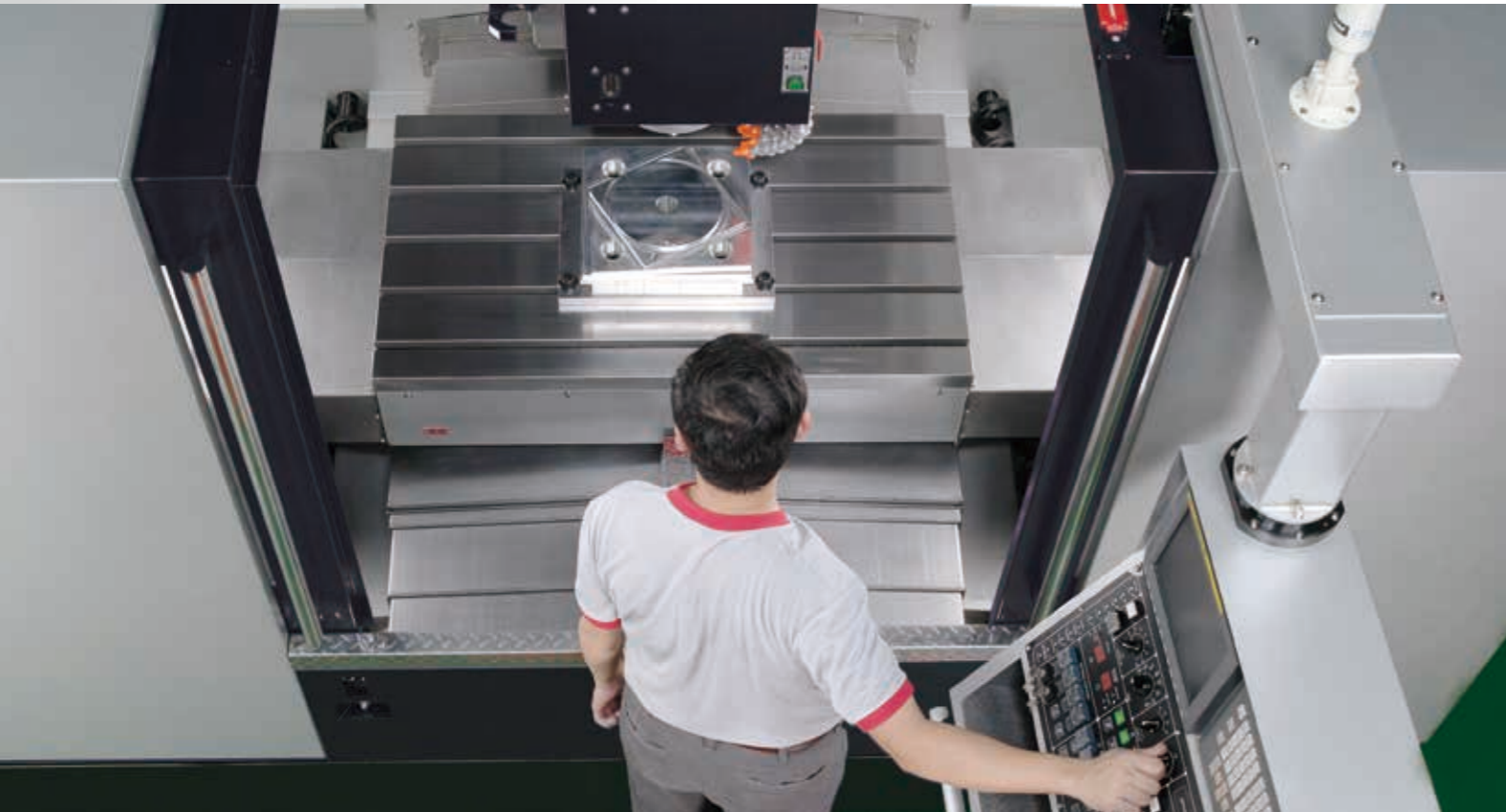

Standard and optional accessories



Coolant around spindle (STD)



Work light (STD)

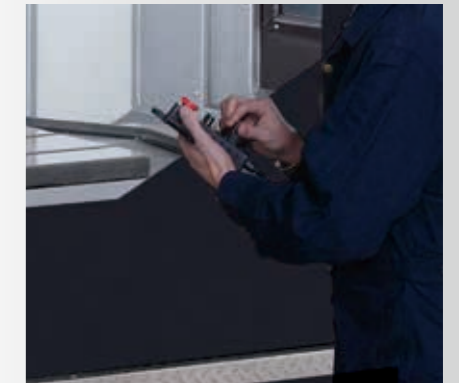

Remote handwheel control (STD)



Air blast coolant system (STD)



Spray gun and air blast (STD)



Operation cycle finish and alarm lights (STD)

Ergonomic design

The layout and design of the control panel as well as access to the working envelope have been defined by machine operators with experience in the field. In addition to the swivel/rotating control panel with angled keyboard, especially wide opening working envelope door have been reduced to an absolute minimum. Even with very large workpiece, over head crane loads can be easily swung over to the middle of the table.

Easy clean

To clean the interior and working envelope, the machine equipped with a front access purge spray gun and air blast located at the left and right, easy to reach.

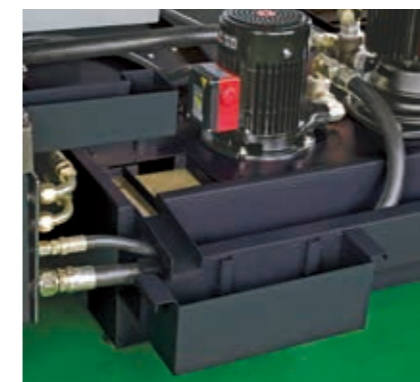

Recycling lubrication oil collector (STD)



Spindle temperature control system (STD)



4th axis interface prepared (OPT)

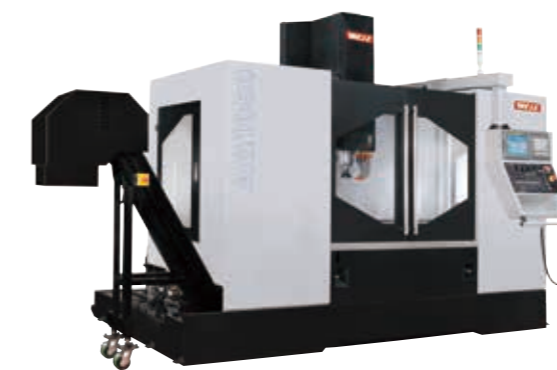
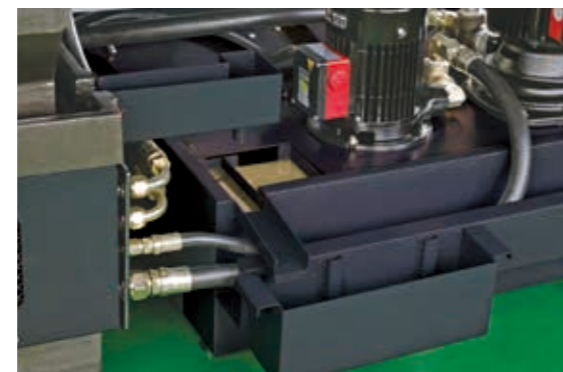

Caterpillar type chip conveyor (OPT)

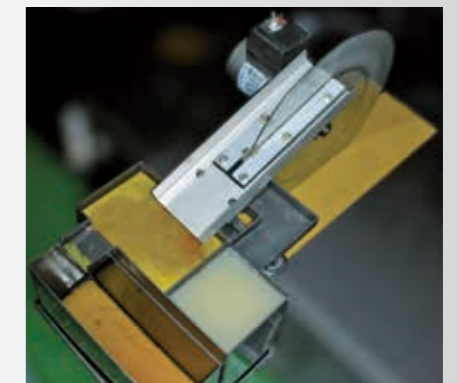

Oil skimmer (OPT)

AQ850	AQ1050	AQ1265	AQ1465	AQ1665	AA 65 Series	AA 80 Series	AA 90 Series	AQ Series	VQ Series	UG Series	VTC Series	
					RB Series	SB Series	LB Series	MB Series	HB Series	UB Series	MG Series	MVB Series

Tool Shank and Pull Stud Dimension

Unit : mm(inch)

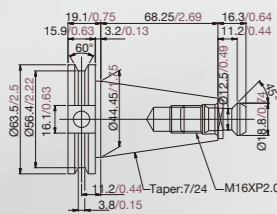

CAT40

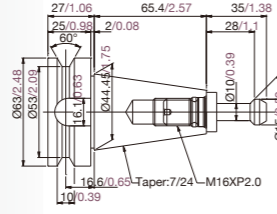

BT40

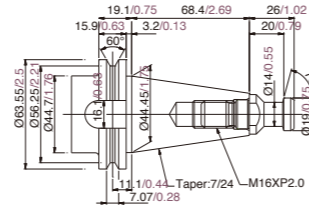

DIN40

Machine Dimension and Space Requirement

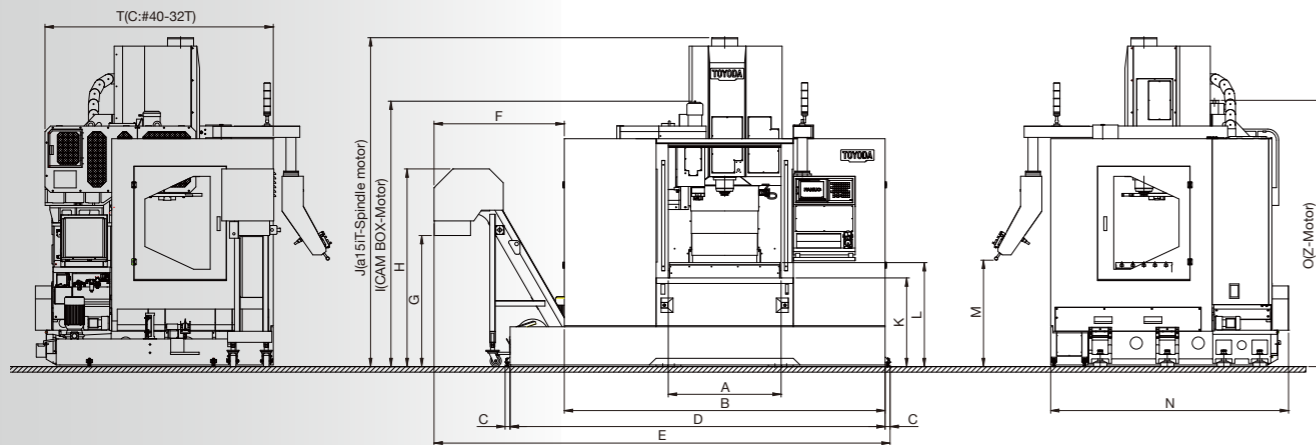
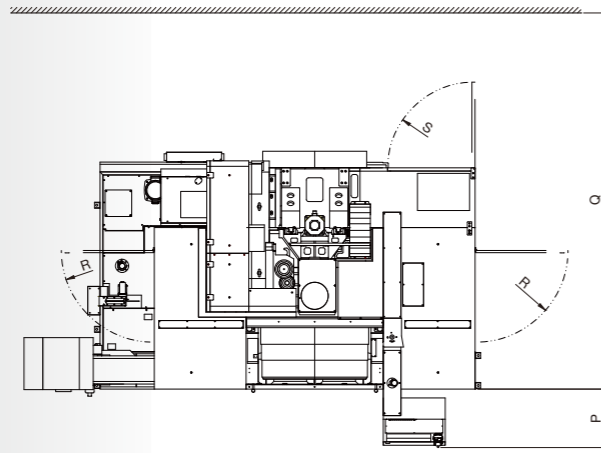

Unit : mm(inch)

Model	A	B	C	D	E	F	G	H	I	J	K	L	M	N	O	P	Q	R	S	T
AQ850	1020 (40.2)	2900 (114.2)	45 (1.8)	3390 (133.5)	4130 (162.6)	1180 (46.5)	1185 (46.7)	1790 (70.5)	2400 (94.5)	2975 (117.1)	800 (31.5)	940 (37)	960 (37.8)	2150 (84.6)	2410 (94.9)	530 (20.9)	3400 (133.9)	R835 (32.9)	R782 (30.8)	2065 (81.3)
AQ1050	1200 (47.2)	3100 (122)		4300 (169.3)	4300 (169.3)	1150 (45.3)														
AQ1265	1400 (55.1)	3440 (135.4)		3570 (140.6)	4640 (182.7)															
AQ1465	1600 (63)	3920 (154.3)	45 (1.8)	3920 (154.3)	5120 (201.6)	1150 (45.3)	1180 (46.5)	1790 (70.5)	2530 (99.6)	3100 (122)	800 (31.5)	940 (37)	960 (37.8)	2420 (95.3)	2530 (99.6)	580 (22.8)	3750 (147.6)	R835 (32.9)	R893 (35.2)	2160 (85)
AQ1665	1750 (68.9)	4340 (170.9)		4340 (170.9)	5540 (218.1)															

Inside of Working Area Dimensions

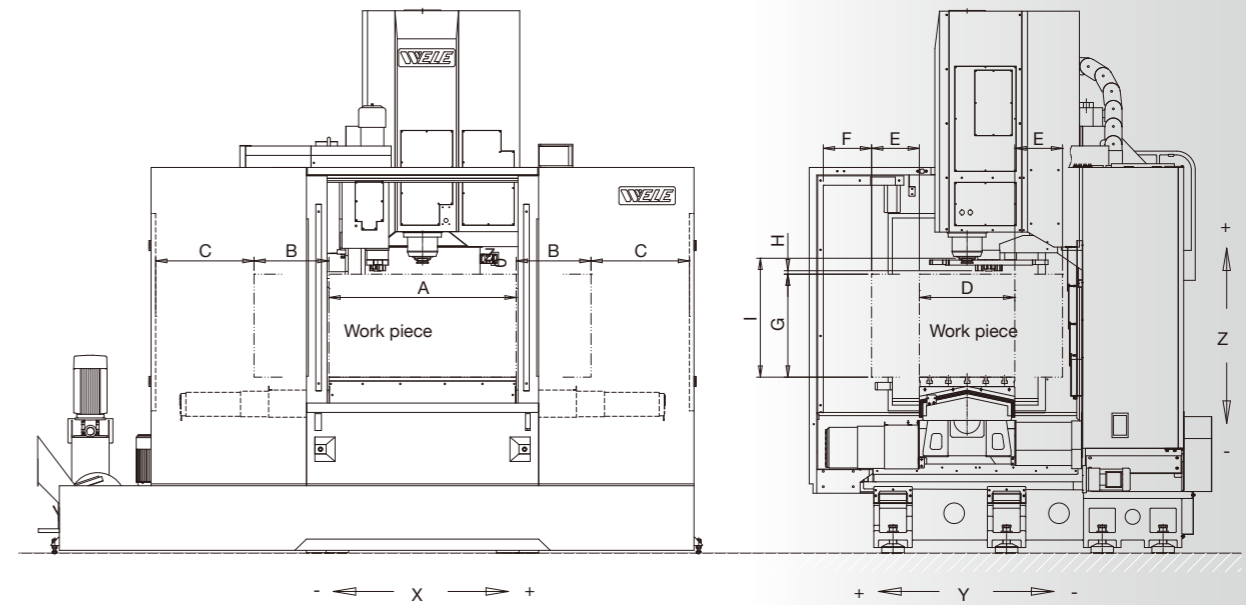

Unit : mm(inch)

Model	A	B	C	D	E	F	G	H	I
AQ850	1000 (39.4)	400 (15.7)	525 (20.7)	510 (20.1)	255 (10.0)	260 (10.2)	550 (21.7)	20 (0.8)	125-635 (4.9-25)
AQ1050	1200 (47.2)	510 (20.1)	415 (16.3)						
AQ1265	1400 (55.1)	600 (23.6)	395 (15.6)						
AQ1465	1600 (63)	700 (27.6)	435 (17.1)	650 (25.6)	325 (12.8)	210 (8.3)	660 (26.0)	20 (0.8)	150-760 (5.9-29.9)
AQ1665	1750 (68.9)	800 (31.5)	470 (18.5)						

Table Dimensions

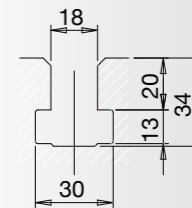
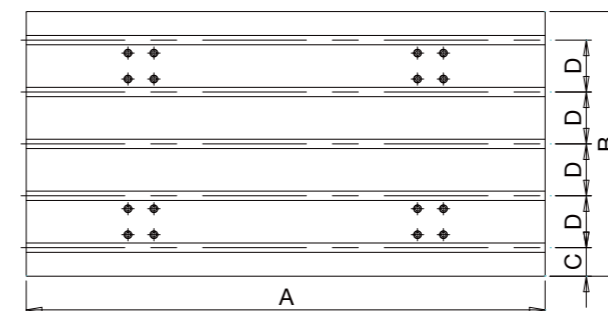

Unit : mm(inch)

Model	A	B	C	D
AQ850	1000 (39.4)	510 (20.1)	55 (2.2)	100 (3.9)
AQ1050	1200 (47.2)	510 (20.1)	55 (2.2)	100 (3.9)
AQ1265	1400 (55.1)	650 (25.6)	75 (3)	100 (3.9)
AQ1465	1600 (63)	650 (25.6)	75 (3)	100 (3.9)
AQ1665	1750 (68.9)	650 (25.6)	75 (3)	100 (3.9)

AQ850	AQ1050	AQ1265	AQ1465	AQ1665	AA 65 Series RB Series	AA 80 Series SB Series	AA 90 Series LB Series	AQ Series MB Series	VQ Series HB Series	UG Series UB Series	VTC Series MG Series	MVB Series
-------	--------	--------	--------	--------	---------------------------	---------------------------	---------------------------	------------------------	------------------------	------------------------	-------------------------	------------

Technical specifications

Specification / Model	Unit	AQ850	AQ1050	AQ1265	AQ1465	AQ1665
Travel						
X travel	mm (in)	800 (31.5)	1,020 (40.2)	1,200 (47.2)	1,400 (55.1)	1,600 (63.0)
Y travel	mm (in)	510 (20.1)		650 (25.6)		
Z travel	mm (in)	510 (20.1)		610 (24.0)		
Distance from spindle nose to table top	mm (in)	125-635 (4.9-25)		150~760 (5.9~29.9)		
Table						
Table size (X direction)	mm (in)	1,000 (39.4)	1,200 (47.2)	1,400 (55.1)	1,600 (63.0)	1,750 (68.9)
Table size (Y direction)	mm (in)	510 (20.1)		650 (25.6)		
Table load capacity	kg (lb)	500 (1,102.3)	600 (1,322.8)	1,000 (2,204.6)		
Spindle						
Spindle speed	rpm	Direct driven / 10000		Direct driven / 10000		
Spindle motor (cont./30 min. rating)	kW (HP)	5.5/7.5 (7.5/11)		5.5/7.5 (7.5/11)		
Spindle Torque (cont./30 min. rating)	Nm (lb-ft)	35/48 (25.9/35.5)		35/48 (25.9/35.5)		
Spindle taper		BBT40		BBT40		
Feedrate						
Rapid traverse rate (X axis)	mm(in)/min	48,000 (1,889.8)		36,000 (1,417.3)		
Rapid traverse rate (Y axis)	mm(in)/min	48,000 (1,889.8)		36,000 (1,417.3)		
Rapid traverse rate (Z axis)	mm(in)/min	36,000 (1,417.3)		30,000 (1,181.1)		
Cutting feedrate	mm(in)/min	1-10,000 (0.04-393.7)		1-10,000 (0.04-393.7)		
Tool magazine						
Tool magazine capacity	pockets	24		24		
Max. tool diameter/ adjacent pocket empty	mm (in)	80/150 (3.1/5.9)		80/150 (3.1/5.9)		
Max. tool length	mm (in)	250 (9.8)		250 (9.8)		
Max. tool weight	kg (lb)	7 (15.4)		7 (15.4)		
Accuracy						
Positioning accuracy (JIS 6338)	mm (in)	±0.005/300 (0.0002/11.8)		±0.005/300 (0.0002/11.8)		
Positioning accuracy (VDI 3441)	mm (in)	P ≤ 0.012 (0.0005)		P ≤ 0.015 (0.0006)		
Repeatability (JIS 6338)	mm (in)	±0.003 (0.0001)		±0.003 (0.0001)		
Repeatability (VDI 3441)	mm (in)	Ps ≤ 0.006 (0.0002)		Ps ≤ 0.008 (0.0003)		
Space requirement & weight						
Machine length	mm (in)	2,900 (114.2)	3,100 (122.0)	3,440 (135.4)	3,920 (154.3)	4,340 (170.9)
Machine width	mm (in)	2,150 (84.6)		2,420 (95.3)		
Machine height	mm (in)	2,900 (114.2)		3,025 (119.1)		
Machine weight	kg (lb)	6,700 (14,771)	7,200 (15,873.3)	7,700 (16,975.6)	8,100 (17,857.5)	8,600 (18,959.8)

** Product specifications and accessories are subject to change without notice.

Standard and optional accessories

● : Standard ○ : Option X : Not available

Specification / Model	AQ850	AQ1050	AQ1265	AQ1465	AQ1665
*BBT40 spindle taper	●	●	●	●	●
*DIN40 spindle taper	○	○	○	○	○
*CAT40 spindle taper	○	○	○	○	○
*DIN50 spindle taper with its tool magazine	X	X	○	○	○
*CAT50 spindle taper with its tool magazine	X	X	○	○	○
*HSK A63 spindle taper with its tool magazine	○	○	○	○	○
*HSK A100 spindle taper with its tool magazine	X	X	○	○	○
*10,000 rpm belted spindle (BT#40)	●	●	●	●	●
*12,000 rpm direct driven spindle (7.5/11HP) BBT40	○	○	○	○	○
*12,000 rpm direct driven spindle (15/20HP) BBT40	○	○	○	○	○
*15,000 rpm direct driven spindle (20/25HP) BBT40	○	○	○	○	○
*Column raise up for 200mm	○	○	○	○	○
*Spindle oil cooler	●	●	●	●	●
*Centralized automatic lubricating system	●	●	●	●	●
*Roof enclosure guarding system	●	●	●	●	●
*Flood coolant system (Pump & tank)	●	●	●	●	●
*Recycling lubricating oil collector for 3 axes	●	●	●	●	●
*Chip auger	●	●	●	●	●
*Caterpillar types conveyor and bucket	○	○	○	○	○
*20 capacity of umbrella type tool magazine (Tool holder #40)	○	○	X	X	X
*24 capacity of arm type tool magazine (Tool holder #40)	●	●	●	●	●
*32 capacity of arm type tool magazine (Tool holder #40)	○	○	○	○	○
*40 capacity of arm type tool magazine (Tool holder #40)	○	○	○	○	○
*Rigid tapping	●	●	●	●	●
*Switch for manual tool clamping	●	●	●	●	●
*Remote handwheel control	●	●	●	●	●
*Work light	●	●	●	●	●
*Operation cycle finish and alarm lights	●	●	●	●	●
*RS232 interface	●	●	●	●	●
*Spray hose for chip wash down	●	●	●	●	●
*Foundation bolt kit	●	●	●	●	●
*Machine manuals	●	●	●	●	●
*Linear scale feedback system for 3 axes	○	○	○	○	○
*Coolant through the tool adapter	○	○	○	○	○
*Coolant through the spindle (Form A)	○	○	○	○	○
*Automatic tool length measurement (Renishaw or Blum)	○	○	○	○	○
*Automatic workpiece measuring system (Renishaw or Blum)	○	○	○	○	○
*4th axis interface prepared	○	○	○	○	○
*CNC rotary table	○	○	○	○	○
*FANUC 0iMD controller	●	●	●	●	●
*FANUC 31iMB controller	○	○	○	○	○
*Mitsubishi M830 controller	○	○	○	○	○
*Heidenhain iTNC 530 controller	○	○	○	○	○

** Product specifications and accessories are subject to change without notice.