

CONTI® SYNCHRODRIVE N10 Nubbed Belt

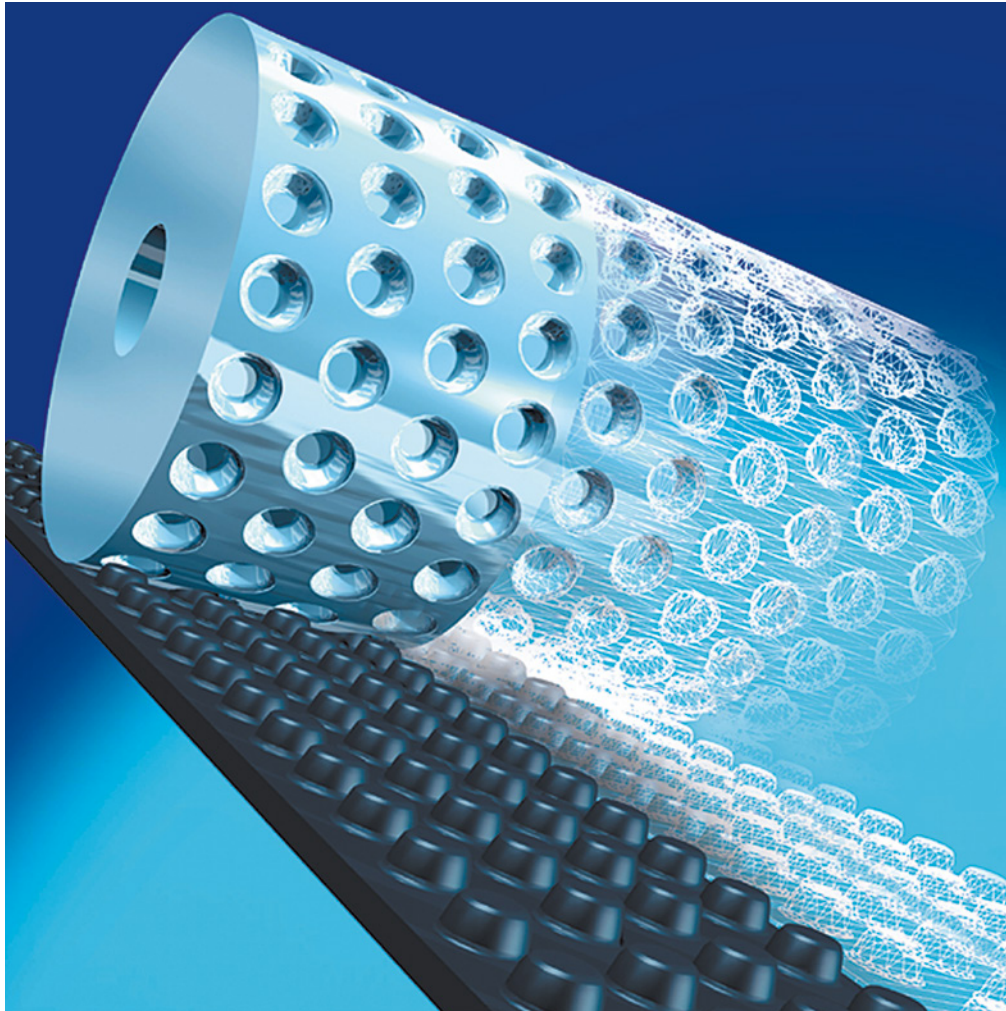

© Registered trademark of Continental



CONTI® SYNCHRODRIVE N10

Excellent high precision, synchronous transmission:
Self-guiding CONTI® SYNCHRODRIVE N10 nubbed belts with steelcord tension members for innovative designs and new applications.

Modern power transmission technology links dynamics, precision and in-service reliability with optimum cost-effectiveness. Mulco offer a wide range of drive elements from polyurethane as well as complete drive solutions. As a development partner and original equipment manufacturer for various industries we know the requirements of the markets. Our products give a wide range of opportunities to users and designers. So, in combination with matched components, the CONTI® SYNCHRODRIVE N10 nubbed belt forms a versatile complete system that paves the way for new drive designs and entirely new applications.

Small belt width and reliable alignment – the CONTI® SYNCHRODRIVE N10 nubbed belt ideally meets both these requirements. Its surface with the nubs in a staggered pattern allows positive-engaging and self-guiding drives. Furthermore, the nubs lead to smooth meshing in both directions of belt travel, thereby ensuring high-precision and synchronous transmission, also for linear drive applications. The belts – manufactured from hard-wearing polyurethane and reinforced with steelcord tension members – guarantee excellent efficiency and constant belt tension.

For use with nubbed belts, ContiTech Antriebssysteme has developed matching components – pulleys, supporting/ guiding rails with recesses and clamping plates. So a complete system is available whose versatility enables entirely new designs and completely new applications of transport and linear drives, e.g. for positioning plotter pens.

Please request technical support from your Mulco sales partner.

Belt measurements and design

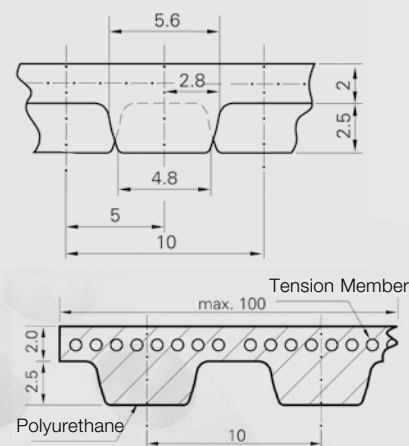

- Nub pitch length in direction of belt travel 10 mm
- Axial distance between rows of nubs 10 mm
- Max. belt width 100 mm
- Belt body made of hard-wearing polyurethane resistant to various agents

Special types:

- Coated Types to reduce friction wear, e.g. fabric coating on both sides
- Special reverse side design, e.g. to transport hot or sensitive materials
- Subsequent additions to nubbed belts, e.g. cleats or brushes
- Mechanical processing, e.g. punching of holes in belts for vacuum conveyors
- antistatic fabric on either side of the belt

Recessed pulley N10

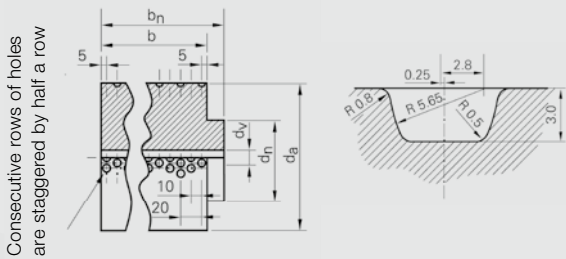
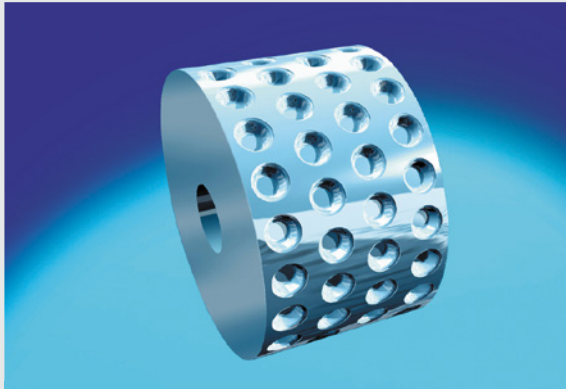

- Standard rib: perfect contact around pulley
- No side flanges on pulley: Belt width is same as pulley width
- Grooved pulleys as idler pulleys – but smooth idler pulleys are also available
- Made of steel or aluminium

Supporting/guiding rail N10

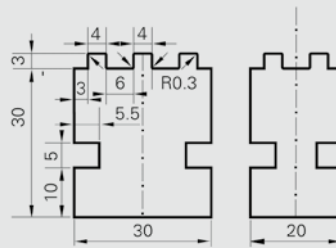
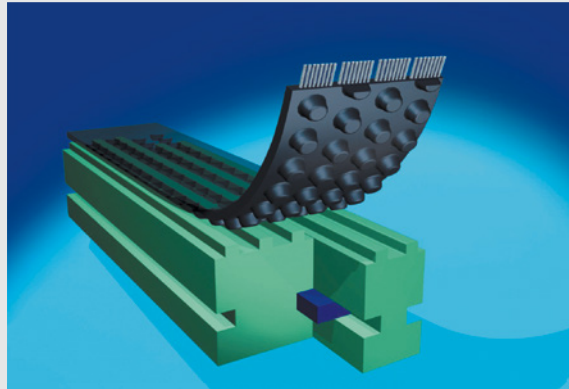

- Friction-reduced and wear-resistant NDPE rails for transport functions
- Support and guide the belt over long centre distances
- Modular design of supporting rail for width variety
- Gap between rows of nubs acts as a guide

Clamping plate N10

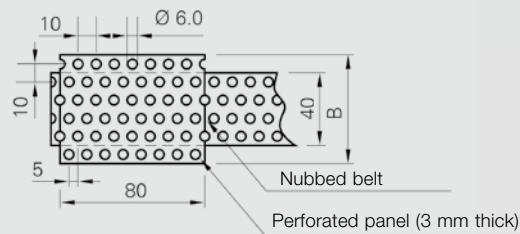
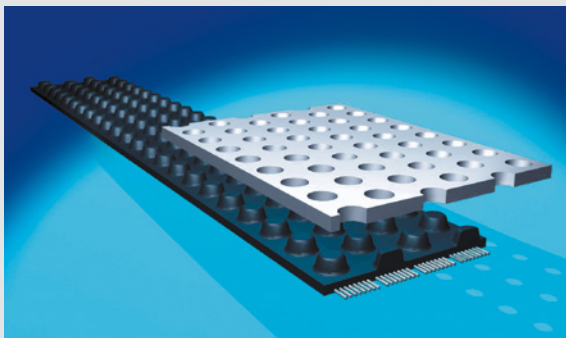

$$B_{min} = \text{Belt width} + 20 \text{ mm}$$

- To fasten one or both belt ends
- Positive joint that interlocks with nubs
- Easy to fit with available tooling (a reinforcement plate may be added)
- Variable end fastening due to hole spacing of 10 mm

CONTI® SYNCHRODRIVE N10

Load on nub flank of the CONTI® SYNCHRODRIVE N10

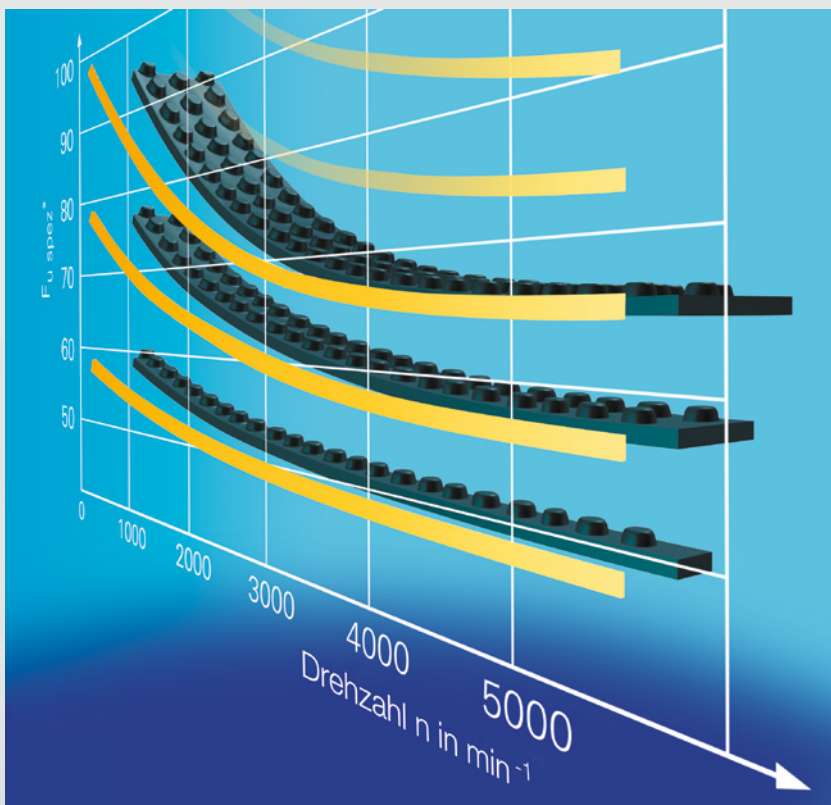

Speed n rpm	$F_{u\ spez^*}$ N (1 nub · 10 mm)
0	35,5
100	33,5
500	29,0
1000	25,7
1500	23,5
2000	21,9
3000	19,4
4000	17,6
5000	16,2

*for each meshing nub in direction of belt travel (max. 12) and for each 10 mm belt width

Belt width

$$b = \frac{\text{Peripheral force}}{\text{Meshing nubs} \cdot F_{u\ spez}}$$

Allowable tension member load F_{zul} in N for CONTI® SYNCHRODRIVE N10

Belt width in mm	20	40	60	80	100
N 10 HF for linear drives	1300	2600	3900	5200	6500
N10 HF-V for transport drives*	650	1300	1950	2600	3250

* Endless joined type, belt lengths 1,000 mm or longer, shorter belts upon request

Minimum number of teeth, min. diameter

Recessed pulley	z min	16
	d_a min [mm]	49,49
Tensioning idler running on the nub side	d min [mm]	40
Tensioning idler running on the reverse side	d min [mm]	50

calculation outside diameter $d_a = \frac{z \cdot t}{\pi} - 1,44$



Available types

Nubbed belt N10

M – Cut to length as required (meters)

V – Endless joined type from 1000 mm length

PAN – PA fabric on the nub side, antistatic execution

PAR – PA fabric on the reverse side, antistatic execution

HF – High Flexibility

Standard length: 30 m

M15 - N10 - 40 HF

M15 Open ended length in m

N10 Nub pitch length

40 Width 40 mm

HF Flexible type

Nubbed pulley N10

Nubbed pulley for positive transmission of power

Grooved pulley for return and guiding

Tensioning idler for inner and outer arrangement

P24 - N10 - 40

P24 Pulley with 24 nubs / row of nubs

N10 Nub pitch length 10 mm

40 Width 40 mm

Supporting/guiding rail N10

Modular design in various widths up to 2 m long

Recommendation: Belt width + 10 mm

FS40 - 2000

FS40 Rail width 40 mm

2000 Length of rail

Clamping plate N10

Max clamping length 80 mm

Recommendation: Belt width + 20 mm

K60 - 80

K60 Width 60 mm

80 Length 80 mm

Benefits of the complete system:

- **self-guiding system:** no side flanges needed on pulleys
- **non-directional:** same meshing performance in both directions of belt travel
- **polygon-free:** smooth rolling around pulleys thanks to contact with flat belt area
- **noise-minimised and low-vibration:** continuous rolling, smooth meshing of nubs into recesses
- **narrow width graduation:** available in steps of 10 mm
- **homogenous distribution of forces in the belt:** no force components acting laterally thanks to symmetrical nub geometry and balanced tension member arrangement (S/Z winding)

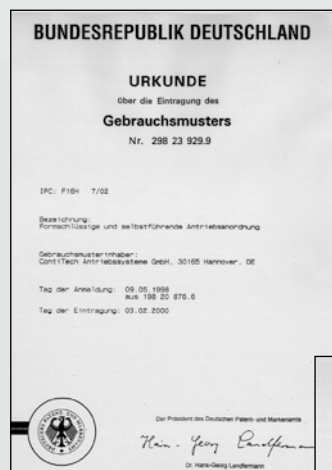

Mulco b@lt-pilot

Your direct road to perfect design solutions

Mulco belt-pilot – online support at www.mulco.net

Let others talk about being close to the customer, we as the market leading provider of polyurethane timing belts actually live by the idea. Mulco-Europe EWIV's secret of success has always been largely due to advising our customers before they enter the design stage. Mulco belt-pilot is taking our customer dedication a critical step further ahead. Our interactive Internet service offering enables you to calculate your personal design solutions online. Whatever field of technology you are interested in - power transmission, linear, transport or components - start Mulco belt-pilot at www.mulco.net for 24/7 access to the actual product information, CAD downloads and calculations you need.

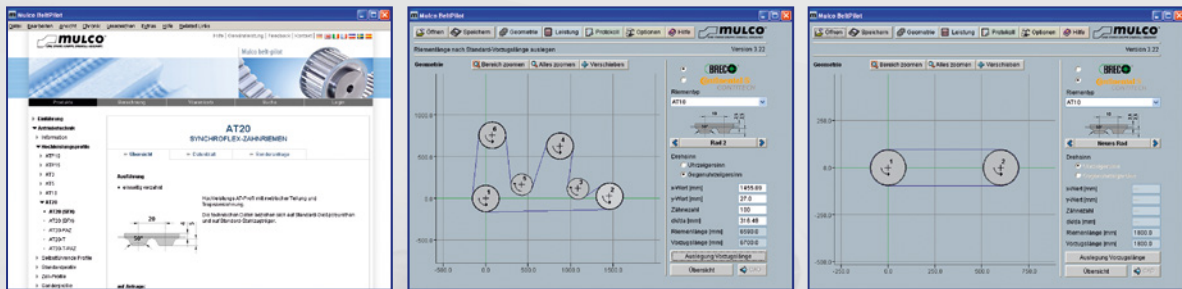

Mulco b@lt-pilot

Many benefits.

- ▶ Interactive service offering with video-based e-learning option
- ▶ Extensive product databases
- ▶ Free use of CAD downloads
- ▶ Import the CAD drawings into your CAD system
- ▶ Calculate timing belts, pulleys and components
- ▶ Email inquiries supported



Polyurethane timing belt welder

Welds what belongs together

The portable TSG 5 welder – ready for a quick change

Even top-quality products will eventually wear out. The same applies to polyurethane timing belts which, from time to time, need to be replaced. We designed the portable TSG 5 welder to assist you in replacing drive units that take a lot of mounting effort and are difficult to access due to upstream machine components. The portable TSG 5 welder is easy to operate and allows you to weld polyurethane timing belts onsite, immediately in or at the machine. The TSG 5 welding unit is available in two versions: for belt widths up to 50 mm and for belt widths up to 100 mm.

One welder, many benefits

- Suitable for all timing belt profiles
- Short machine downtimes
- Easy to operate
- Flexible through long power cords
- Air-cooled, no water supply required
- Powerful heater output

Standard package

- Welder with belt-specific, replaceable weld face
- Control unit for automatic welding and cooling down
- Control unit and welder connect by metal-reinforced cable
- Transport case with tools

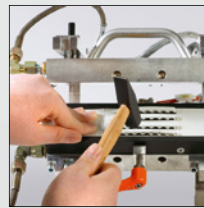
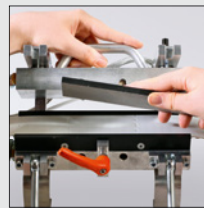
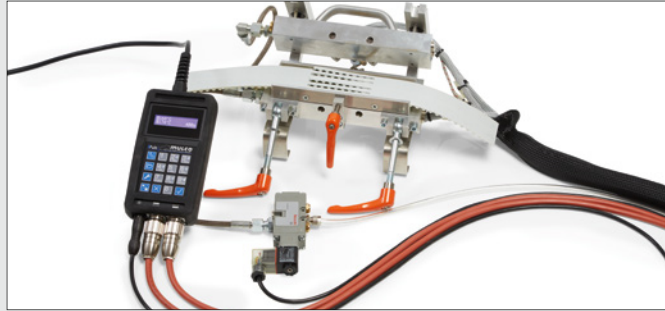

Technical data TSG 5 - 50

Operating voltage: 230 V/50 Hz

Power consumption: 1.2 kW

Welder dimensions:

W 240 mm x H 220 mm x D 170 mm

Welder weight: approx. 7.5 kg*

Control unit dimensions:

Typ IV / PPuls

W 100 mm x H 190 mm x D 45 mm

Control unit weight: approx. 1.0 kg

Carrying case weight: approx. 6.0 kg

Technical data TSG 5 - 100

Operating voltage: 230 V/50 Hz

Power consumption: 2 kW

Welder dimensions:

W 240 mm x H 220 mm x D 220 mm

Welder weight: approx. 9.5 kg*

Control unit dimensions:

Typ IV / PPuls

W 100 mm x H 190 mm x D 45 mm

Control unit weight: approx. 1.0 kg

Carrying case weight: approx. 6.0 kg

* including connecting leads



Special accessories

- Hydraulic punch
- Weld jigs for all standard belt profiles
- Punch box
- All units available separately

List of Catalogues

All our information at a glance

Polyurethane Timing Belts

- BRECO®, BRECOFLEX® timing belts
- BRECO®, BRECOFLEX® – Processing of timing belts
- BRECO®, BRECOFLEX® flat belts
- BRECO® ATN-system
- BRECOprotect® – Timing Belts
- BRECObasic® – Timing Belts
- BRECOMove, BRECOFLEXmove – Timing Belts

All product information can be requested from your Mulco Partner.

New information material available for download at www.mulco.net

- CONTI® SYNCHROFLEX Polyurethane Timing Belts. Overall catalog
- CONTI® SYNCHROCHAIN CARBON Heavy-Duty Timing Belts
- CONTI® SYNCHRODRIVE Polyurethane Synchronous Drive Belts
- CONTI® SYNCHRODRIVE N10 Nubbed Belt

Pulleys and Accessories

- PULLEYS & COMPONENTS for polyurethane timing belt drives
- Portable TSG 5 welder for polyurethane timing belts



MULCO® is a registered trademark of Wilhelm Herm. Müller GmbH & Co. KG, Heinrich-Nordhoff-Ring 14, 30826 Garbsen, Germany.

© 2021 Mulco-Europe EWIV. All rights reserved. Reproduction of the entirety of text or parts prohibited.



Sales partners Germany



Hilger u. Kern GmbH
Industrietechnik
Käfertaler Straße 253
68167 Mannheim
Phone: +49 621 3705-0
Fax: +49 621 3705-403
e-mail: antriebstechnik@hilger-kern.de
www.hilger-kern.com



Wilhelm Herm. Müller GmbH & Co. KG
Heinrich-Nordhoff-Ring 14
30826 Garbsen
Phone: +49 5131 4522-0
Fax: +49 5131 4522-110
e-mail: info@whm.net
www.whm.net



Roth GmbH & Co. KG
Andernacher Straße 14
90411 Nürnberg
Phone: +49 911 99521-0
Fax: +49 911 99521-70
e-mail: info@roth-ing.de
Chat: by MS-Teams
www.roth-ing.de



Anton Klocke Antriebstechnik GmbH
Senner Straße 151
33659 Bielefeld
Phone: + 49 521 95005-01
Fax: + 49 521 95005-11
e-mail: info@klocke-antrieb.de
www.klocke-antrieb.de



REIFF Technische Produkte GmbH
Tübinger Straße 2-6
72762 Reutlingen
Phone: +49 7121 323-3130
Fax: +49 7121 323-3460
e-mail: zahnriemen@reiff-gruppe.de
www.reiff-tp.de



Walter Rothermundt GmbH & Co. KG
Mülforter Zeug 12
41199 Mönchengladbach
Phone: +49 2166 45133-0
e-mail: info@rothermundt.de
www.rothermundt.de

Sales partner France



BINDER MAGNETIC
1 allée des Barbanniers
92632 Gennevilliers Cedex
France
Phone: +33 1 46 13 80 80
e-mail: info@binder-magnetic.fr
www.binder-magnetic.com

Sales partner Sweden



Aratron AB
Solna Strandväg 78, 4tr
171 54 Solna
Sweden
Phone: +46 8 404 16 00
e-mail: info@aratron.se
www.aratron.se

Sales partner Spain



DINAMICA Drive Solutions, S.A.
Ctra. N. II, km 592,6
08740 S. Andreu de la Barca
Spain
Phone: +34 93 6533-500
e-mail: dinamica@dinamica.net
www.dinamica.net

Sales partner Austria



Haberkorn GmbH
Modecenterstraße 7
1030 Wien
Austria
Phone: +43 1 74074-0
Fax: +43 1 74074-99
e-mail: antriebselemente@haberkorn.com
www.haberkorn.com

Sales partner United Kingdom



Transmission Developments Co. (GB) Ltd
Dawkins Road
Poole, Dorset, BH15 4HF
United Kingdom
Phone: +44 1202 675555
Fax: +44 1202 677466
e-mail: info@transdev.co.uk
www.transdev.co.uk

