

3000 Series



Medium Duty Cabinet



Shown with optional casters and powerstrip assembly

This versatile line of cabinets is a modular enclosure suitable for military and data communication applications. Available in a wide range of heights, depths and panel widths, the 3000 series cabinet can meet practically any packaging requirement.

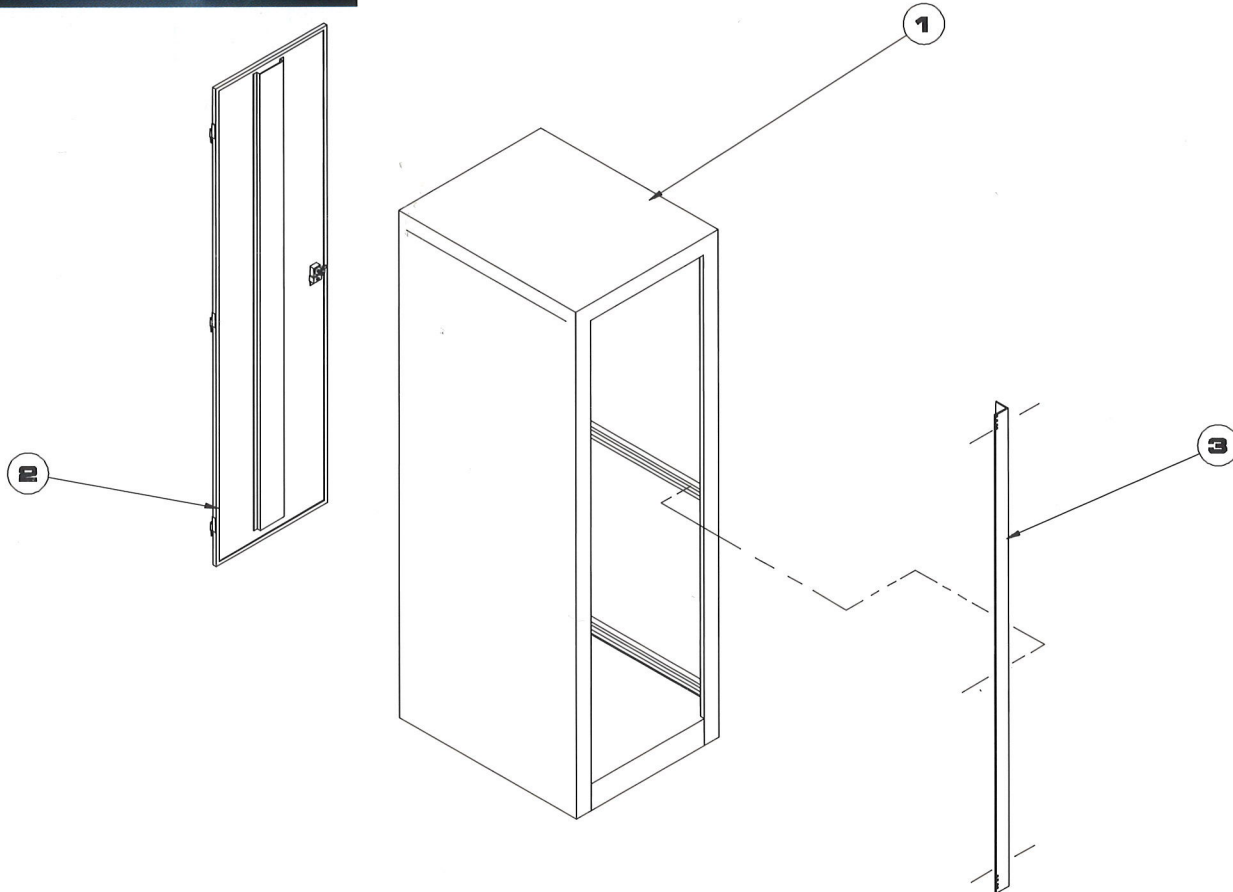

Notes

1. Cabinet frame consists of 16 gauge C.R.S. non-removable sides, 16 gauge C.R.S. top, and 12 gauge C.R.S. bottom.
2. Removable rear door is made from 16 gauge C.R.S.
3. Mounting angles (2 pair) are made from 12 gauge C.R.S. with #10-32 tapped holes (front), .270" diameter clearance holes (rear) per EIA RS-310 specs. Finish: zinc & bright.

For Sales Service, Order Entry and Expediting: **(317) 897-7009**
 For Engineering and/or Technical Assistance: **(317) 897-7010**



3000 Series

Medium Duty Cabinet

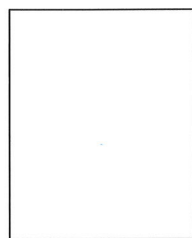

TOP VIEW

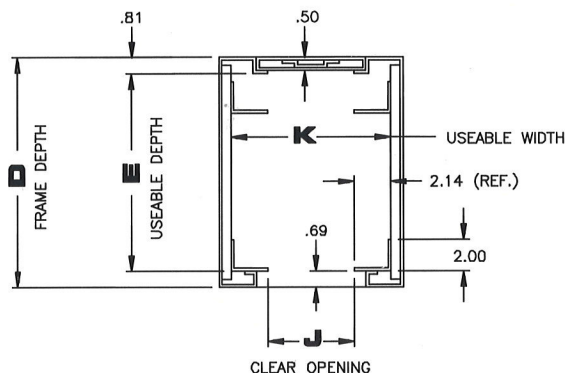

SECTION M-M

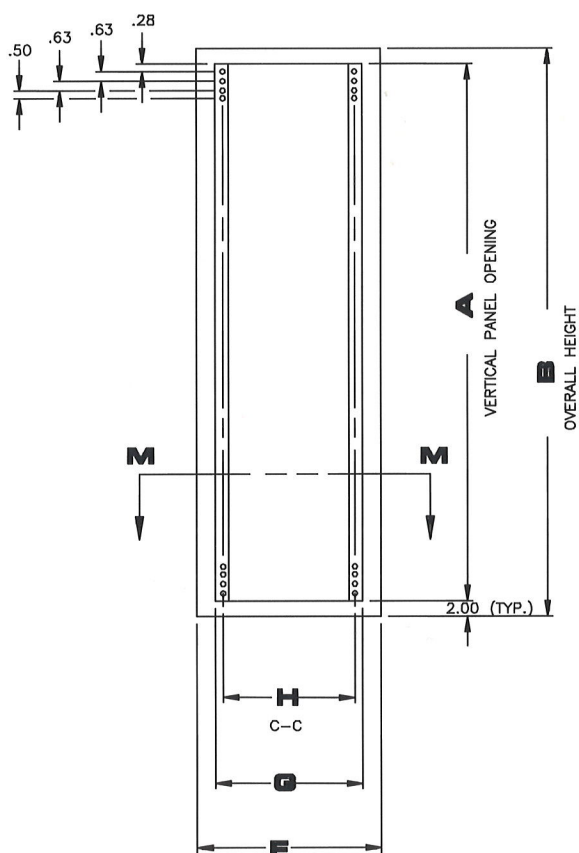

FRONT VIEW

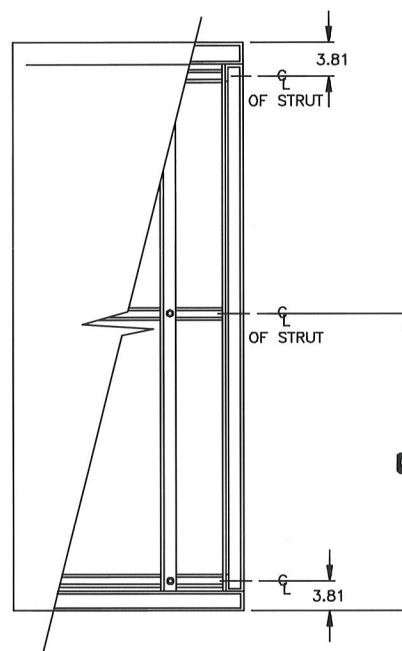

RIGHT SIDE VIEW

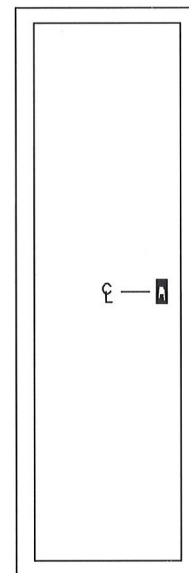

REAR VIEW

All dimensions in inches unless stated otherwise

For Sales Service, Order Entry and Expediting: (317) 897-7009
 For Engineering and/or Technical Assistance: (317) 897-7010

3000 Series



Medium Duty Cabinet

Ordering Information

VR3000 - XX - XX - XX - XX - XXXX - XXXXX

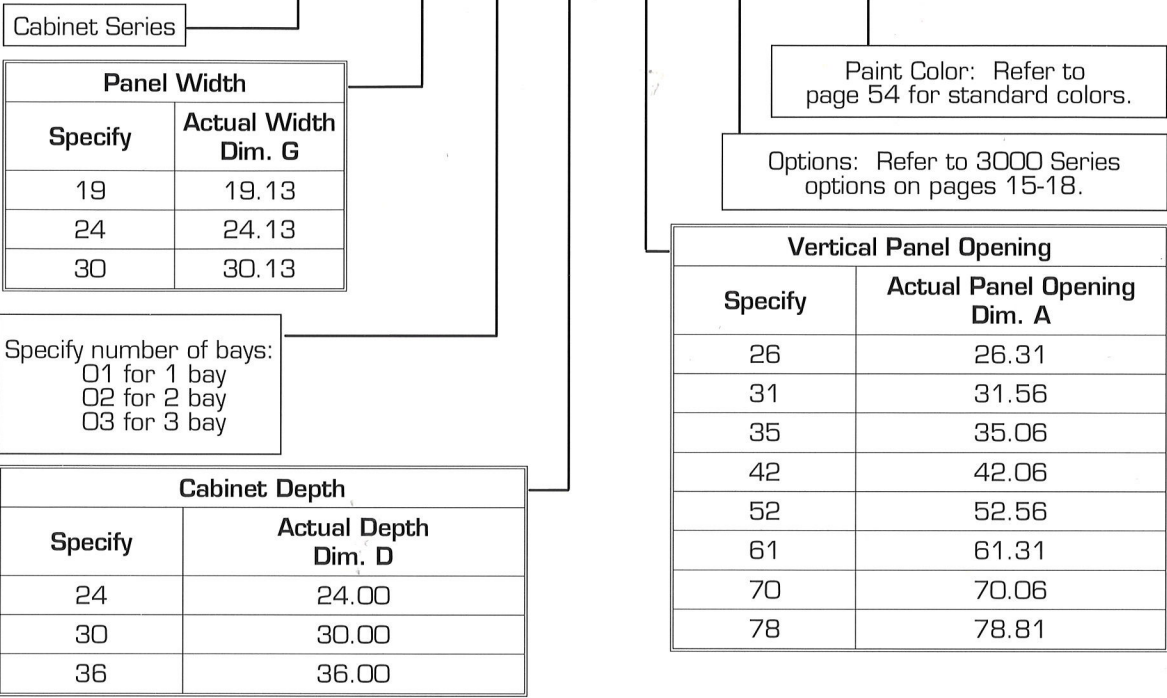

Cabinet Series

Panel Width	
Specify	Actual Width Dim. G
19	19.13
24	24.13
30	30.13

Specify number of bays:
 01 for 1 bay
 02 for 2 bay
 03 for 3 bay

Cabinet Depth	
Specify	Actual Depth Dim. D
24	24.00
30	30.00
36	36.00

Paint Color: Refer to page 54 for standard colors.

Options: Refer to 3000 Series options on pages 15-18.

Vertical Panel Opening	
Specify	Actual Panel Opening Dim. A
26	26.31
31	31.56
35	35.06
42	42.06
52	52.56
61	61.31
70	70.06
78	78.81

Panel Width					
Order Width	Frame Width F	Panel Width G	Hole C-C H	Clear Opening J	Useable Width K
19	24.00	19.13	18.31	17.94	22.25
24	29.00	24.13	23.31	22.94	27.25
30	35.00	30.13	29.31	28.94	33.25

Vertical Panel Opening			
Order P.O.	Panel Opening A	Overall Height B	Strut Location C
26	26.31	30.31	—
31	31.56	35.56	—
35	35.06	39.06	—
42	42.06	46.06	—
52	52.56	56.56	28.28
61	61.31	65.31	32.66
70	70.06	74.06	37.03
78	78.81	82.81	41.41

Cabinet Depth		
Order Depth	Frame Depth D	Useable Depth E
24	24.00	22.50
30	30.00	28.50
36	36.00	34.50

All dimensions in inches unless stated otherwise

For Sales Service, Order Entry and Expediting: (317) 897-7009
 For Engineering and/or Technical Assistance: (317) 897-7010



3000 Series Options

<p>LOUVERED SIDE, TOP</p> <p>TO SPECIFY, USE OPTION NUMBER 30LSPT</p>	<p>LOUVERED SIDE, BOTTOM</p> <p>TO SPECIFY, USE OPTION NUMBER 30LSPB</p>	<p>LOUVERED SIDE TOP & BOTTOM</p> <p>TO SPECIFY, USE OPTION NUMBER 30LSPTB</p>
<p>LOUVERED REAR DOOR TOP</p> <p>TO SPECIFY, USE OPTION NUMBER 30LRDT</p>	<p>LOUVERED REAR DOOR BOTTOM</p> <p>TO SPECIFY, USE OPTION NUMBER 30LRDB</p>	<p>LOUVERED REAR DOOR TOP & BOTTOM</p> <p>TO SPECIFY, USE OPTION NUMBER 30LRDTB</p>
<p>LOUVERED TOP PAN</p> <p>TO SPECIFY, USE OPTION NUMBER 30LTP</p>	<p>KEY LOCKS</p> <p>TO ORDER REAR DOOR WITH KEY LOCK, SPECIFY 30ORDKL</p> <p>TO ORDER FRONT DOOR WITH KEY LOCK, SPECIFY 30FDFKL</p>	
<p>LOUVERS</p> <p>EACH LOUVER PROVIDES APPROXIMATELY .9 SQUARE INCHES OF OPEN AREA.</p>		

For Sales Service, Order Entry and Expediting: (317) 897-7009
 For Engineering and/or Technical Assistance: (317) 897-7010

3000 Series Options



<p>CASTER BASE - TOP VIEW</p> <p>SEE CHART ON PAGE 14.</p> <p>SEE CHART ON PAGE 14.</p> <p>NOTE: WHEN OPTIONAL BASE IS ORDERED, THE CABINET BOTTOM IS INVERTED.</p>	<p>STANDARD DUTY CASTERS</p> <p>2.0" DIA. DUAL WHEEL CASTERS—150 LB. RATING (EACH CASTER)</p> <p>ALL CASTERS ARE SWIVEL</p> <p>TO SPECIFY, USE OPTION NUMBER</p> <p>30C8D</p>
<p>STANDARD DUTY CASTER BASE</p> <p>2.0" DIA. DUAL WHEEL CASTERS—150 LB. RATING (EACH CASTER)</p> <p>ALL CASTERS ARE SWIVEL</p> <p>TO SPECIFY, USE OPTION NUMBER</p> <p>30CB8D</p>	<p>MEDIUM DUTY CASTERS</p> <p>4.0" DIA. CASTER, 200 LB. CAPACITY (EACH CASTER) FRONT SWIVEL, REAR RIGID</p> <p>TO SPECIFY, USE OPTION NUMBER</p> <p>30CMD</p> <p>TO ORDER ALL SWIVEL CASTERS USE OPTION NO.</p> <p>30CMD8</p>
<p>MEDIUM DUTY CASTER BASE</p> <p>4.0" DIA. CASTER, 200 LB. CAPACITY (EACH CASTER) FRONT SWIVEL, REAR RIGID</p> <p>TO SPECIFY, USE OPTION NUMBER</p> <p>30CBMD</p> <p>TO ORDER ALL SWIVEL CASTERS USE OPTION NO.</p> <p>30CBMD8</p>	<p>HEAVY DUTY CASTERS</p> <p>4.0" DIA. CASTER, 300 LB. CAPACITY (EACH CASTER) FRONT SWIVEL, REAR RIGID</p> <p>TO SPECIFY, USE OPTION NUMBER</p> <p>30CHD</p> <p>TO ORDER ALL SWIVEL CASTERS USE OPTION NO.</p> <p>30CHD8</p>
<p>HEAVY DUTY CASTER BASE</p> <p>4.0" DIA. CASTER, 300 LB. CAPACITY (EACH CASTER) FRONT SWIVEL, REAR RIGID</p> <p>TO SPECIFY, USE OPTION NUMBER</p> <p>30CBHD</p> <p>TO ORDER ALL SWIVEL CASTERS USE OPTION NO.</p> <p>30CBHD8</p>	<p>STATIONARY BASE</p> <p>TO SPECIFY, USE OPTION NUMBER</p> <p>308B</p>

For Sales Service, Order Entry and Expediting: (317) 897-7009
 For Engineering and/or Technical Assistance: (317) 897-7010



3000 Series Options

<p align="center">STANDARD MOUNTING ANGLE</p> <p>TO SPECIFY, USE OPTION NUMBER</p> <p align="center">30MA</p> <p>TWO PAIR OF MOUNTING ANGLES (1 PAIR TAPPED #10-32 HOLES)-FRONT (1 PAIR .270 DIA. CLEARANCE HOLES) -REAR ARE PROVIDED WITH THE CABINET UNLESS OTHERWISE SPECIFIED.</p> <p>FOR ADDITIONAL MOUNTING ANGLES WRITE THE OPTION NUMBER TIMES THE NUMBER OF PAIR DESIRED. EXAMPLE: 30MA X 2</p>	<p align="center">MOUNTING "Z" RAIL</p> <p>TO SPECIFY, USE OPTION NUMBER</p> <p align="center">30MZR</p> <p>TAPPED #10-32 HOLES (PER E.I.A. RS-310 SPECS.)</p> <p>TO REPLACE STANDARD MOUNTING ANGLES WITH OPTIONAL MOUNTING "Z" RAILS, PLACE "R" IN FRONT OF THE OPTION NO. EXAMPLE: R30MZR</p> <p>TO ORDER MOUNTING "Z" RAILS IN ADDITION TO MOUNTING ANGLES, WRITE THE OPTION NUMBER TIMES THE NUMBER OF PAIR DESIRED</p> <p>EXAMPLE 30MZR X 2</p>
<p align="center">MOUNTING CHANNEL</p> <p>TO SPECIFY, USE OPTION NUMBER</p> <p align="center">30MC</p> <p>TO REPLACE THE STANDARD MOUNTING ANGLES WITH MOUNTING CHANNELS, PLACE "R" IN FRONT OF THE OPTION NUMBER EXAMPLE: R30MC</p> <p>TO ORDER MOUNTING CHANNELS IN ADDITION TO MOUNTING ANGLES, WRITE THE OPTION NUMBER TIMES THE NUMBER OF PAIR DESIRED EXAMPLE 30MC X 2</p>	<p align="center">OFFSET MOUNTING CHANNEL</p> <p>TO SPECIFY, USE OPTION NUMBER</p> <p align="center">300MC</p> <p>TO REPLACE THE STANDARD MOUNTING CHANNELS WITH OFFSET MOUNTING CHANNELS, PLACE "R" IN FRONT OF THE OPTION NUMBER EXAMPLE: R300MC</p> <p>TO ORDER OFFSET MOUNTING CHANNELS IN ADDITION TO MOUNTING ANGLES, WRITE THE OPTION NUMBER TIMES THE NUMBER OF PAIR DESIRED. EXAMPLE 300MC X 2</p>
<p align="center">POWERSTRIP ASSEMBLY</p> <p>TO SPECIFY, USE OPTION NUMBER</p> <p align="center">30PS</p>	<p align="center">BUS BAR ASSEMBLY</p> <p>TO SPECIFY, USE OPTION NUMBER</p> <p align="center">30BB</p>

For Sales Service, Order Entry and Expediting: (317) 897-7009
 For Engineering and/or Technical Assistance: (317) 897-7010

3000 Series Options



FACE MOUNTED DOOR

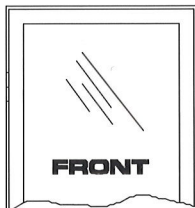
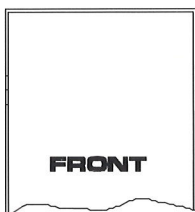
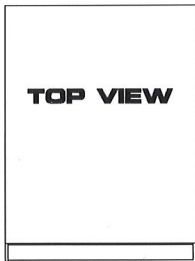

2.00

TO SPECIFY, USE
OPTION NUMBER

30FMD

TO ORDER A DOOR
WITH GLASS USE
OPTION NUMBER

30FMDG

PLEXIGLAS[®] COLOR
NO. 2094 GRAY
WILL BE USED UNLESS
OTHERWISE SPECIFIED.

REAR HORIZONTAL SPACE DIVIDER

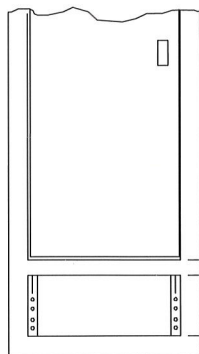

REAR

TO SPECIFY, USE
OPTION NUMBER

30HSD X P.O.

1.75
P.O.

STANDARD DUTY LIFTING EYES

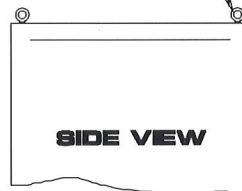
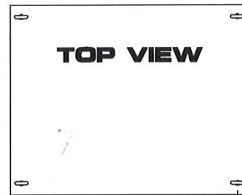

1.12
1.12

LIFTING EYE
(3/8-16 X 1.0" DIA. EYELET)
EYEBOLT LOAD CAPACITY
1400 LBS.

TO SPECIFY, USE
OPTION NUMBER

30ESD

HEAVY DUTY LIFTING EYES

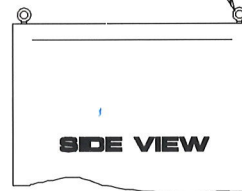
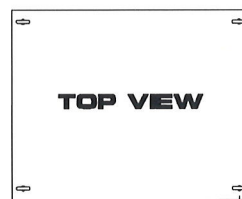

1.12
1.12

LIFTING EYE
(1/2-13 X 1.25 DIA. EYELET)
EYEBOLT LOAD CAPACITY
2600 LBS.

TO SPECIFY, USE
OPTION NUMBER

30EHD

For Sales Service, Order Entry and Expediting: (317) 897-7009
For Engineering and/or Technical Assistance: (317) 897-7010